

The Wireless World

THE
PRACTICAL RADIO
JOURNAL
25th Year of Publication

No. 831.

FRIDAY, AUGUST 2ND, 1935.

VOL. XXXVII. No. 5.

Proprietors: ILIFFE & SONS LTD.

Editor:
HUGH S. POCKOCK.

Editorial,
Advertising and Publishing Offices:
DORSET HOUSE, STAMFORD STREET,
LONDON, S.E.1.

Telephone: Hop 3333 (50 lines).
Telegrams: "Ethaworld, Sedist, London."

COVENTRY: Hertford Street.

Telegrams: "Autocar, Coventry." Telephone: 5210 Coventry.

BIRMINGHAM:

Guildhall Buildings, Navigation Street, 2.
Telegrams: "Autopress, Birmingham." Telephone: 2971 Midland (4 lines).

MANCHESTER: 260, Deansgate, 3.

Telegrams: "Iliffe, Manchester." Telephone: Blackfriars 4412 (4 lines).

GLASGOW: 26B, Renfield Street, C.2.

Telegrams: "Iliffe, Glasgow." Telephone: Central 4857.

PUBLISHED WEEKLY. ENTERED AS SECOND
CLASS MATTER AT NEW YORK, N.Y.

Subscription Rates:

Home, £1 1s. 8d.; Canada, £1 1s. 8d.; other
countries, £1 3s. 10d. per annum.

As many of the circuits and apparatus described in these
pages are covered by patents, readers are advised, before
making use of them, to satisfy themselves that they would
not be infringing patents.

CONTENTS

	Page
Editorial Comment	97
The 1936 Monodial AC Super ..	98
A New Power Output Valve ..	105
Current Topics	107
Radio Data Charts—VIII ..	108
Random Radiations	111
Unbiased	112
Micro-waves for Guiding Ships in Fog	113
Listeners' Guide for the Week ..	114
Ferranti "Nova" Reviewed ..	116
New Apparatus Reviewed ..	118
Broadcast Brevities	119
Letters to the Editor	120
Novel Frequency Generator ..	121
Readers' Problems	122
Principal Broadcasting Stations ..	123

EDITORIAL COMMENT

Censorship of Programmes

The Broadcaster's Responsibility

HOW often has it been argued by supporters of broadcast advertising that there never could be any serious risk of abuse of the microphone for advertising purposes, since this would automatically result in turning away listeners and so destroying the advertising value of the station's publicity? Even if this argument may be a sound one in theory, in practice it does not seem to work.

For some reason the microphone appears to attract the type of advertiser who would find his announcements excluded from good-class newspapers and periodicals.

In America action is at last being threatened against owners of stations who sell time to undesirable advertisers. In one case it is a slimming preparation, regarded as dangerous by the medical profession, which has offended; in France the Government has taken action against stations which have been in the habit of broadcasting lurid details of crimes.

Unless proper control is exercised over broadcasting transmissions there seems to be no limit to the uses to which the microphone will be put, however offensive the nature of the broadcasts may be to self-respecting listeners.

When financial gain in the shape of revenue from advertising programmes is in question, then any advertiser and any publicity material seems to get access to the microphone.

And we need not restrict our investigation to America in the matter of advertising matter in bad taste, for there have been some deplorable

examples in recent Continental programmes.

If we were confident that these broadcasts discouraged listeners so that the position became self-adjusting, we might feel less perturbed, but there does not appear to be enough evidence that unsavoury programmes mean the loss of listeners to reassure us on this point.

This brings us, of course, to the conclusion that broadcasting should be planned on a higher plane than the tastes of the majority of listeners would dictate.

Civilisation itself is based on a code of rules not always universally acceptable but, nevertheless, recognised to be in the best interests of humanity in general. Broadcasting wields an enormous influence for good or evil, and its responsibility is great. It should be subject to an even stricter code than would apply to any other means of approach to the public because of the wider dissemination of its programmes.

The Radio Show

Three Special Numbers

THE annual Radio Show opens to the public at Olympia on Wednesday, August the 14th. This year three special numbers of *The Wireless World* will be devoted to giving our readers a full account of everything of interest.

Next week's Special Issue will be a Show Forecast, giving a guide to the Stands and a general survey of the most important exhibits on which advance information is available.

The issue of August 16th will be a complete Show Report, constituting a Stand-to-Stand record of the exhibition.

In the third Show Number, August 23rd, the technical staff of *The Wireless World* will review the Show, discussing new developments from a critical point of view.

The Wireless World

1936 Monodial AC Super

The Construction, Adjustment and Operation of a Highly Sensitive Quality Receiver

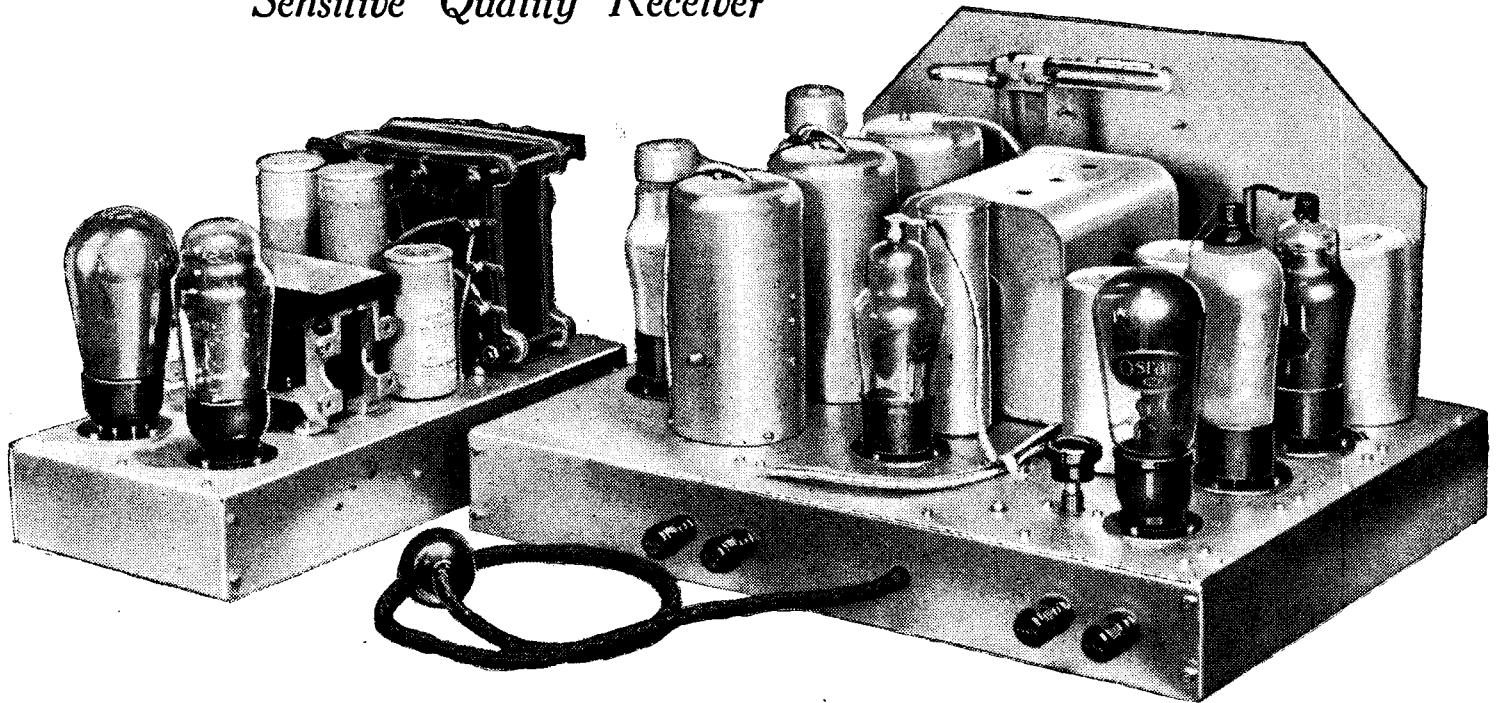

CONSIDERATIONS of theory underlying the design of this receiver were fully dealt with in the previous article, and in this instalment the construction of the set is discussed. The initial adjustments also receive full treatment, and a procedure has been developed which readily enables accurate trimming to be achieved.

THE components are assembled on two aluminium chassis, one for the receiver proper and the other for the output stage and mains equipment. No difficulty will be found in the mechanical construction, and with one or two minor exceptions the order in which the components are mounted is unimportant. The gang condenser, however, should be left to the last. When fitting the switches, fix each to the chassis by its nuts and bolts, but leave these quite loose; then insert the control rod, and only tighten the fixing nuts when this rod is in place. If this procedure is not adopted it will probably prove impossible to insert the rod. Before tightening the set screws on each switch, make sure that they all lie to the same side of the centre line. The control knob for the switches has a standard $\frac{1}{4}$ in. bush, but as the shaft is of smaller diameter a liner is employed, and when inserting it into the knob it is important to see that the slit side of the liner is away from the grub screw, otherwise it will not grip the shaft.

When the components have been mounted, solder five long wires to the tags

on the under side of the gang condenser, three for the fixed plates and two for the frame. Pass these wires through the holes provided in the chassis and secure the condenser.

The wiring should now be commenced, and will be found straightforward and devoid of pitfalls if the details given in the drawings and photographs are carefully followed. It is, however, of greater importance than is often realised to follow the design in the matter of the physical positions of the wires. The general run of the wiring is usually at least as important as the layout of components, for in these days of screened components changes in their positions usually affect the performance only by the changes in the wiring which necessarily follow.

The Wiring

Considerable effort has been expended upon obtaining an arrangement of the wiring which would meet the electrical requirements fully and yet be mechanically rigid and simple enough to depict clearly in a drawing. Although changes in certain

leads will have no effect whatever upon the performance, alterations in others may easily cause instability or some other defect; consequently, a change in the wiring can be considered no more legitimate than a modification in the positions of the components. It is in order that the wiring of the original receiver may be closely followed that the practical wiring diagram is included in this article, and it is recommended that full use be made of it. Were the positions of the leads unimportant, there would be no reason for publishing such a diagram; the wiring could be perfectly well carried out from the circuit diagram alone, if it were important only that the correct points be joined together.

No. 16 gauge wire is used for the heater connections, and it is advised that these leads be first placed in position, since the wire is very stiff. It should, of course, be straightened by stretching it slightly. It is used also for a few other leads where special rigidity is advisable. The rest of the wiring is carried out with No. 18 or No. 20 wire, according to preference. No. 18 is preferable in many cases on account

The 1936 Monodial AC Super—

of its greater stiffness, but nothing larger than No. 20 should be used in the case of the screened leads.

It may be remarked that the screened leads are earthed by clamping them to the chassis by metal straps. Soldered connections to the metal braiding should not be made, for it has proved almost impossible to solder the braiding without charring the insulation, and a breakdown sooner or later is then almost a certainty. Such breakdowns are often intermittent and quite difficult to trace, so that it is as well to remove 90 per cent. of their possibility by refraining from soldering in such cases. Flex leads are fitted to the IF transformers. These should be cut to the correct length and pieces of screened sleeving pushed over them, the metal braiding just being allowed to pass inside the screening cans.

currents, and the longer the leads the greater the chance of unwanted coupling between different circuits. The case is similar with resistances, particularly those joined in the anode or grid circuit of a valve.

The Initial Adjustments

If these points be borne in mind, and the wiring plan carefully followed, there is no reason to anticipate difficulty in getting the receiver to function, and the set should operate perfectly as soon as the necessary initial adjustments have been made. When setting up the set, insert all valves *except the muting valve* and switch on. After allowing a short time for the valves to warm up, check over the voltages and currents and make sure that they are reasonably in accordance with the figures in the accompanying table. They are un-

negligible, and 15 per cent. is not serious, particularly if they are consistent. If one circuit shows a high voltage accompanied by a low current, however, then it must be taken as an indication of a probable fault in that circuit—a valve, resistance, or condenser being the probable cause, or else a mistake in the wiring. It may be remarked that the resistances R24, R25, and R26 in the voltage divider dissipate a fair amount of heat, and the fact that they are hot to the touch is no indication of anything amiss.

The initial adjustments are chiefly to the ganging, and although this may quite well be carried out without additional equipment, it is more easily done if a calibrated oscillator, which need not be modulated, be available. Assuming that such an oscillator can be used, set it at 465 kc/s, insert a condenser in series with its high potential output lead, and connect it between the

IDENTIFYING THE PRINCIPAL COMPONENTS

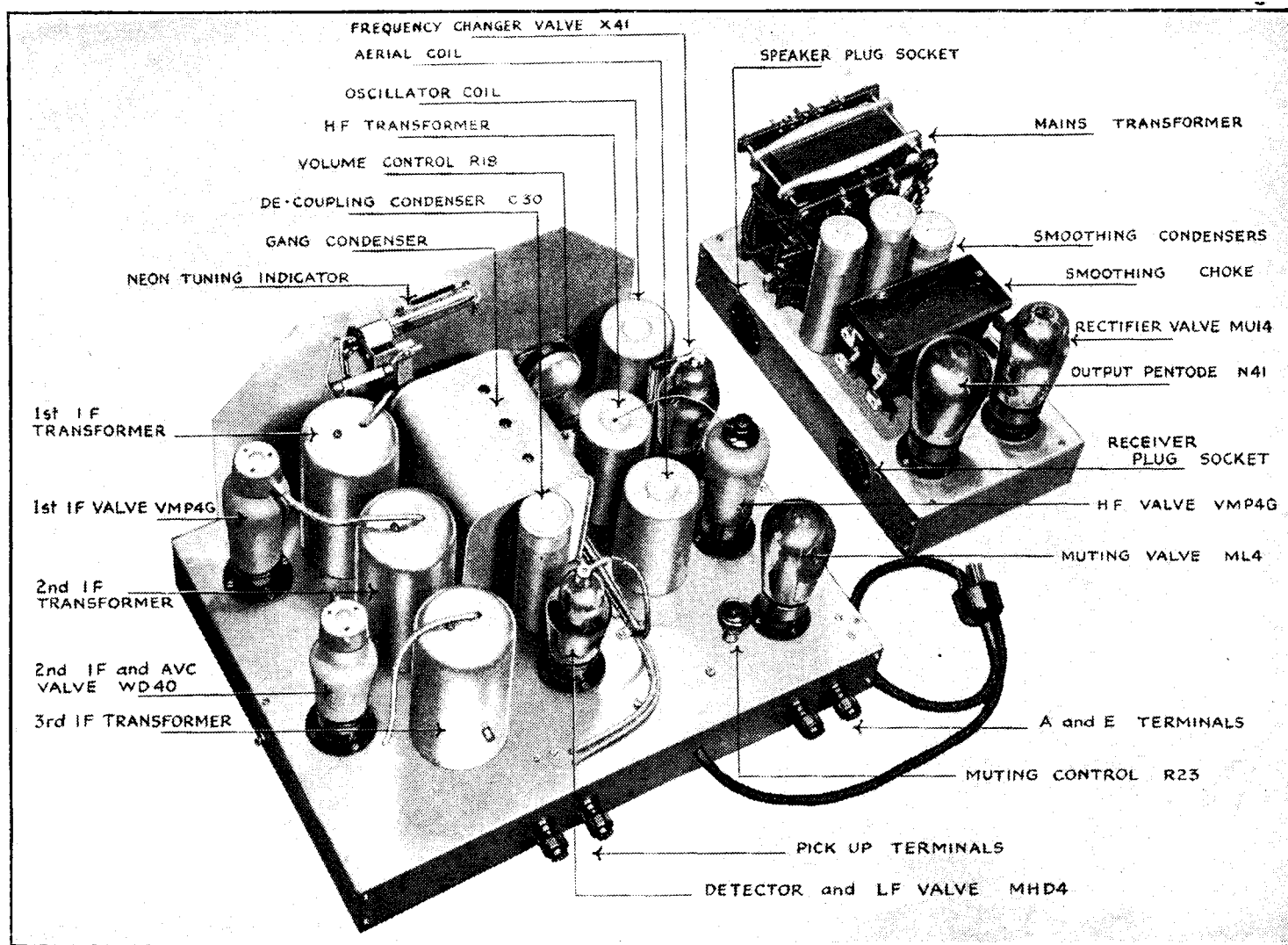

In this view of the apparatus the chief components can readily be seen. The three IF transformers are mounted in a row and the selectivity can be varied by means of a shaft passing through them.

The resistances and many of the condensers employed are fitted with wire ends of lengths varying from 1½ in. to 3 in. In many cases they are longer than necessary, and where this is so they should be cut short. Remember that the leads to a bypass condenser are carrying HF or IF

likely to agree exactly, for they will be affected not only by the permissible variations in resistances, valves, transformers, and mains, but by the accuracy of the meter used and the value of its internal resistance. Variations of about plus or minus 10 per cent., therefore, are usually

grid (top cap WD40) of the second IF valve and the chassis. Loosen the IF transformer coupling nearly to minimum by turning the control knob in an anti-clockwise direction almost as far as it will go. Then trim the third IF transformer primary circuit (top trimmer, rear can) for

HOW TO WIRE UP THE RECEIVER UNIT

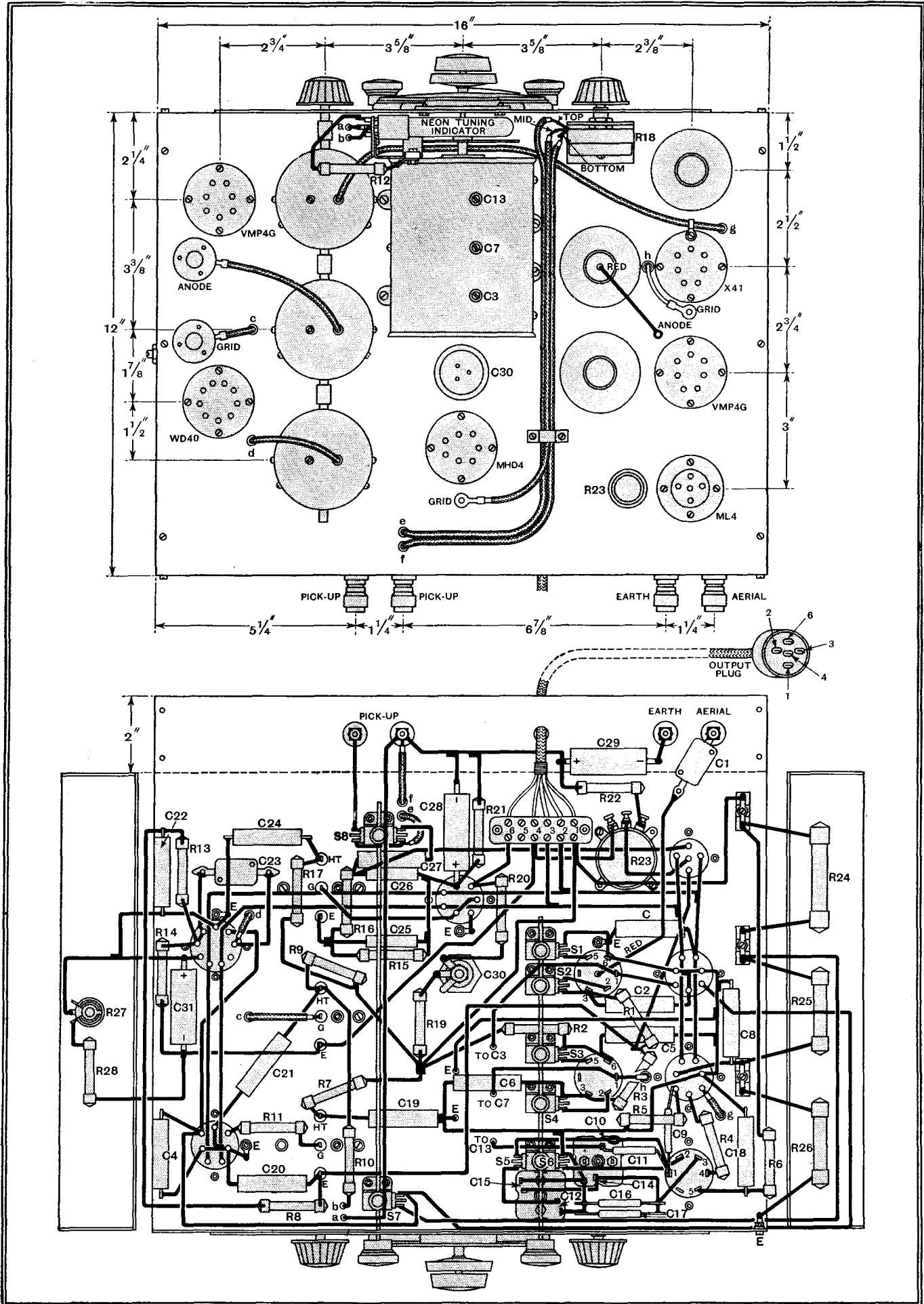

Full details of the wiring and layout of components are shown in these drawings. It is important that the layout of the wiring should be followed closely if unwanted couplings are not to be introduced.

The 1936 Monodial AC Super

maximum response as indicated by maximum deflection on the neon tuning indicator. Then trim the secondary (bottom trimmer, rear can) for maximum volume from the loud speaker if the oscillator be modulated. If it is not modulated the setting can usually be determined by the appearance of a slight hiss at resonance, while the tuning indicator will drop back very slightly.

Having adjusted these two circuits, transfer the oscillator high potential lead to the first IF valve grid and adjust first the secondary (bottom trimmer) and then the primary (top trimmer) of the second transformer (middle can) for maximum deflection of the indicator. A smaller output from the oscillator is advisable on account of the greater amplification now in use. Next clip the oscillator lead to the frequency-changer grid (top cap), and similarly adjust the two trimmers on the first transformer (front can). The IF circuits are now all tuned to 465 kc/s, and should require no further attention. It is worth taking some pains to secure precision of setting of the trimmers, for the adjacent channel selectivity depends en-

tirely upon the accuracy of adjustment. As a safeguard, therefore, it is advisable to check the adjustment of each trimmer

earth terminals, preferably through an artificial aerial, but, if not, through a 0.0002 mfd. condenser, and set it at 1,500 kc/s (200 metres). Set the tuning dial at zero, and the wave-range switch for the medium waveband. Short-circuit the oscillator coil by a short lead terminating in spring clips by connecting the junction of C₉ and C₁₀ to the chassis. This will

prevent the oscillator from functioning. Set the external oscillator to give a large output (0.1-1 volt), and adjust the trimmers on C₃ and C₇ for maximum deflection on the indicator; the trimmer on C₃ will be nearly fully unscrewed. A large input to the set is necessary for adjusting in this manner,

for the procedure depends upon grid current flowing in the HF or FC valves; the grid current causes a potential to appear on the AVC line and changes the current through the first IF valve, so operating the tuning indicator.

Having adjusted

the two trimmers, set the oscillator to 1,400 kc/s and tune the set to this frequency by the tuning dial, again using the neon tube as an indicator of the precise setting. Now reduce the output of the oscillator well below the point at which the tube ceases to give an indi-

before proceeding farther, but this time the oscillator can be left connected to the frequency-changer.

The next step is to adjust the ganging. Connect the oscillator to the aerial and

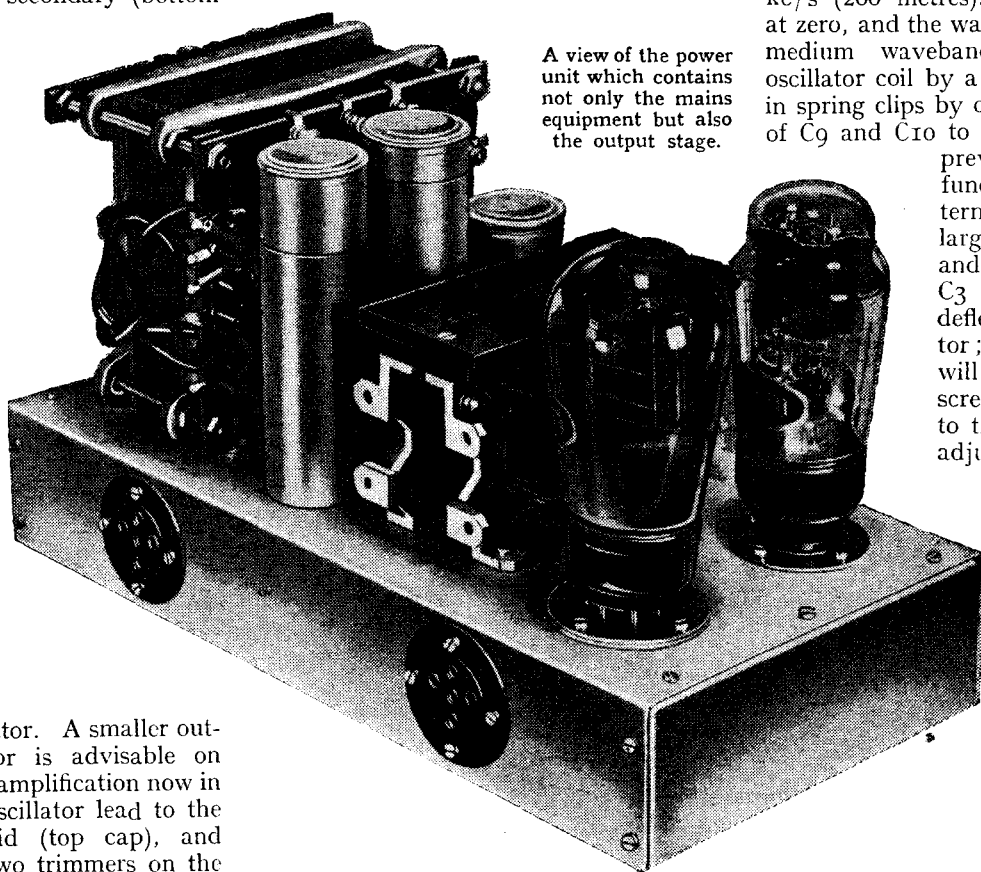

A view of the power unit which contains not only the mains equipment but also the output stage.

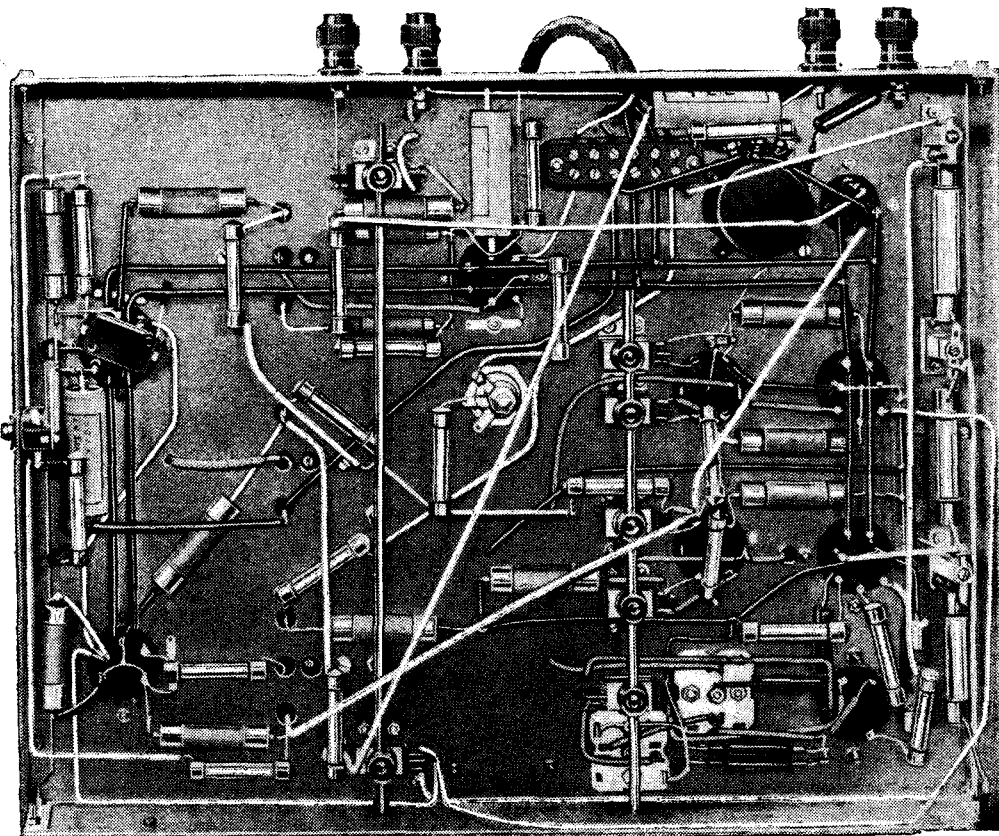
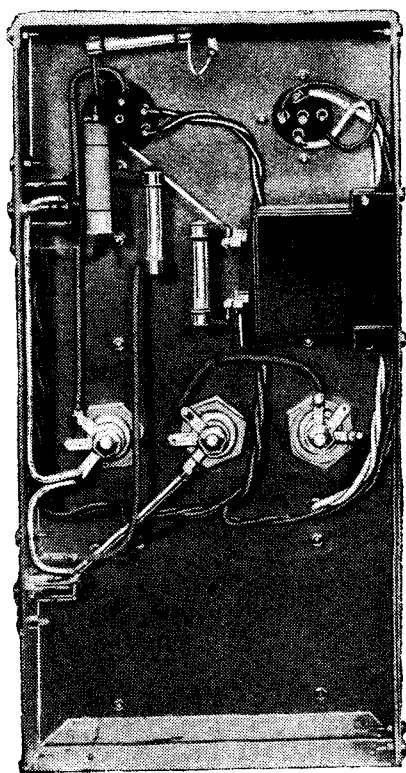

The wiring is clearly shown in these views of the receiver and power chassis. Note the initial sensitivity control R₂₇, which projects through the side of the receiver chassis on the left in the illustration.

HOW TO WIRE UP THE POWER UNIT

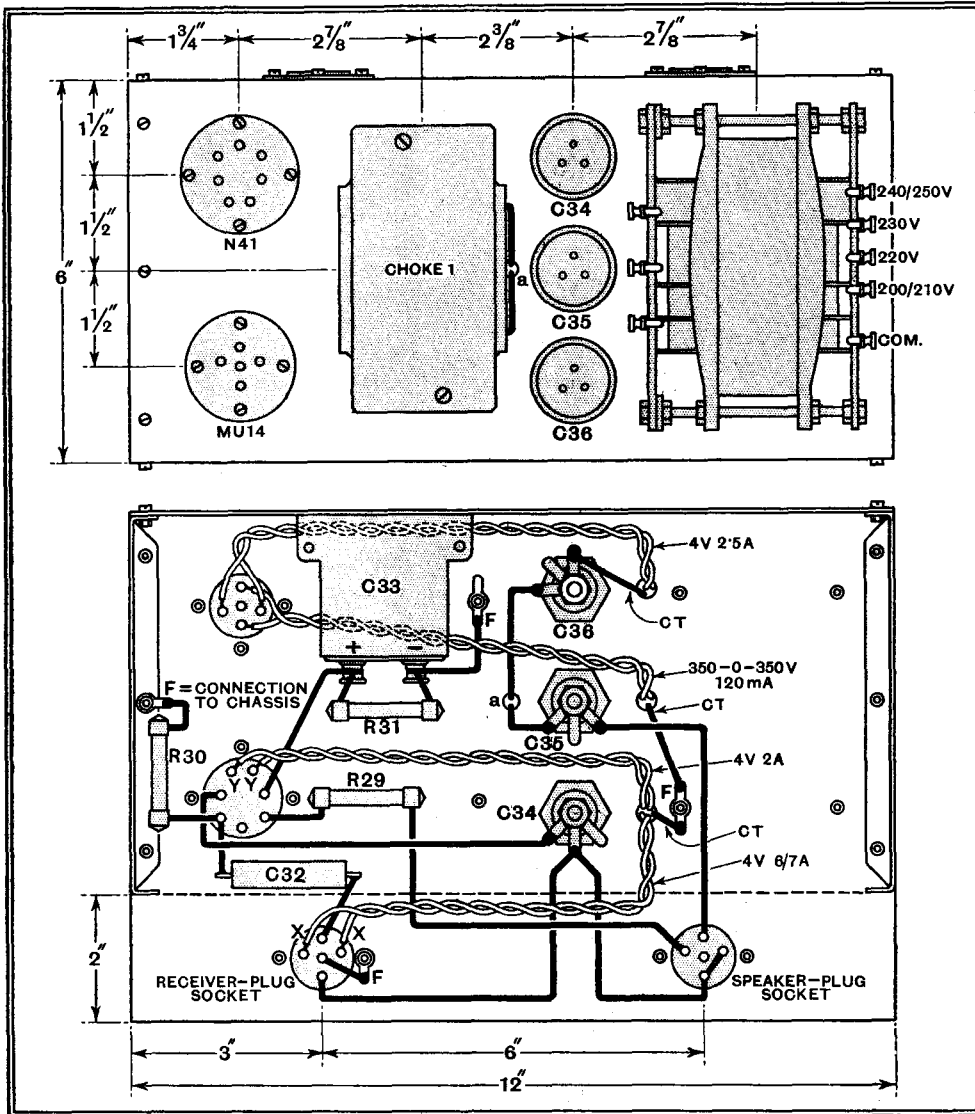

The details of the power unit are shown in these drawings. Few underbase components are fitted and the wiring is straightforward.

cation. Remove the short-circuit from the set oscillator, and adjust the trimmer on C13 for maximum response. The setting of this trimmer is quite critical. If more than one point of response be found, select the strongest, and this is most easily done by reducing the input until only one can be found.

The next step is to replace the short-

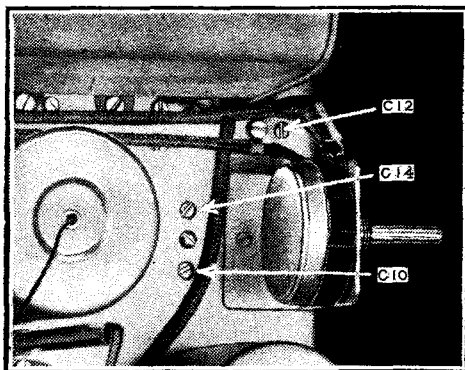

The trimming condensers are readily adjusted by means of an insulated screwdriver. C10 is the medium wave and C14 the long wave padding condenser, while C12 is the long wave parallel trimming condenser.

circuit on the set oscillator, set the ganging oscillator to 600 kc/s (500 metres), and with a large output tune the set to it. Then reduce the oscillator output, remove the short-circuit from the set oscillator, and adjust C10 for maximum response. This setting is critical, and the output from the oscillator should be no more than is necessary to obtain an adequate deflection.

A return to 1,400 kc/s should now be made, and the trimmer on C13 adjusted exactly as described before. The setting found for it this time will probably be only very slightly different from the one found at first. This completes the medium-wave ganging, and it is now the turn of the long waveband. This is done in a similar manner to the medium, but there are fewer adjustments.

Set the oscillator to 300 kc/s (1,000 metres), and, of course, the wave-range switch to the long waveband, and stop the set oscillator from functioning. Tune the set to 300 kc/s by the main tuning control, using, of course, a large output from the oscillator. Reduce the input to the set, remove the short-circuit from the set oscillator, and adjust C12, being careful to keep the input to the set small

enough for only the strongest response to be obtained. Replace the short-circuit on the set oscillator, adjust the external oscillator to give a large output at 160 kc/s (1,875 metres), and tune the set to it. Remove the short-circuit, reduce the input, and adjust C14. It may be found that varying this condenser has little effect. This is because the possible variation represents only a small proportion of the total capacity. In many cases it is hardly necessary to adjust this trimmer, and it is really included only to permit of compensation for variations in the capacities of the fixed portion of the padding.

The Muting Circuit

The ganging is now completed, and it only remains to adjust C3 to suit the actual aerial which is to be used. To do this, tune in a medium-wave station on as low a wavelength as possible, and adjust C3 for maximum response. The muting valve may now be inserted and its control R23 suitably adjusted to suit individual requirements. Experience has shown the ML4 valve to give the best control, but almost any triode will function quite well, and such a different type as the MH4 is very nearly as good. When R23 is fully rotated in a clockwise direction, no muting will be obtained, and when it is fully turned the opposite way, only strong signals will be audible. To adjust R23, tune the set to a point where the background is greatest, the set being tuned to no signal, and slowly turn R23 until

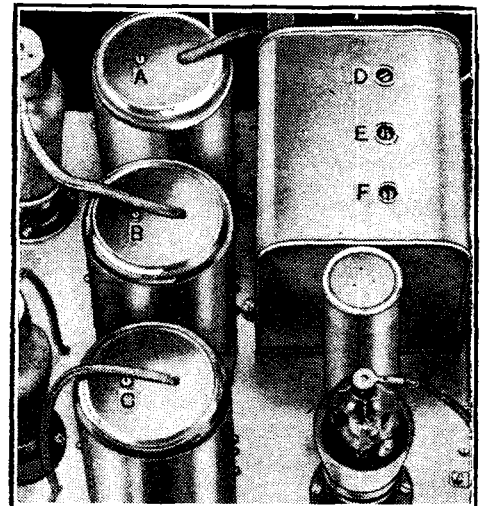

The trimmers on the gang condenser are here lettered D, E, and F, referring to the trimmers on the condenser sections C13, C7, and C3. The trimmers A, B, and C on the IF transformers are in every case primary trimmers on the 1st, 2nd, and 3rd transformers respectively.

silence is just, and only just, secured. It should then be found possible to tune from one end of the scale to the other with the stations suddenly appearing out of a dead silent background. With the set adjusted for maximum selectivity, muting will be obtained between channels in many cases, but not usually when this control is in the high-fidelity position. This is not important, for the same action which prevents muting prevents the sensitivity rising suffi-

The 1936 Monodial AC Super—

ciently for background noises to become obtrusive.

Now, although an oscillator is a very desirable aid to the correct adjustment of the receiver, it is by no means impossible correctly to gang the set without one, and as the procedure is necessarily somewhat different, this will now be dealt with. Remove the muting valve, and screw each IF trimmer fully home, and then unscrew each trimmer one half-turn. The circuits are then very roughly adjusted to 465 kc/s, and the next step is to adjust them accurately. To do this, set the selectivity control at minimum selectivity—that is, fully rotated in a clockwise direction, and tune in a signal. If this be strong, turn the control the other way until it can only just be heard, and adjust each IF trimmer roughly for maximum signals. This will greatly increase the sensitivity, and it should not be difficult to find a station of such strength that a good deflection is obtained on the tuning indicator with the selectivity control nearly fully rotated in an anti-clockwise direction. Each IF trimmer in turn must now be adjusted for maximum response. Start with the secondary of the third transformer and use the ear as an indicator of volume, then proceed to the primary, and thence to the secondary of the second transformer, and so on, for these five using the tuning indicator. This completes the IF adjustment, and it is the turn of the ganging, which must first be carried out on the medium waveband.

Ganging on a Signal

Unscrew C3 nearly fully, and C7 not quite as much. Adjust C13 to have roughly the same capacity as C7, or a little more. Tune in a medium-wave station on as low a wavelength as possible, and adjust C3 and C7 for maximum response. If this leads to C3 being screwed up considerably, reduce C13 slightly and retune; on the other hand, if no optimum setting for C3 can be found, increase C13 and retune. It should be noted that the trimming on C3 is very flat, and care must be taken in determining the indications. If the set is being used near a local station of low wavelength, such as the London National, a somewhat simpler method is possible. The trimmers should be set as before, and the oscillator stopped by short-circuiting its grid coil as described under ganging with a test oscillator. Tune the set to the station by noting the resonance condition on the tuning indicator, and adjust C3 and C7. Then remove the short-circuit from the oscillator and adjust C15 for maximum response, being careful to choose the strongest if more than one point can be found.

When satisfied with the adjustment, tune in a station at the upper end of the waveband—Brussels on 620 kc/s if possible—and adjust C10 while rocking the tuning dial backwards and forwards until the optimum combination of settings be found. Then return to a weak low-wave-

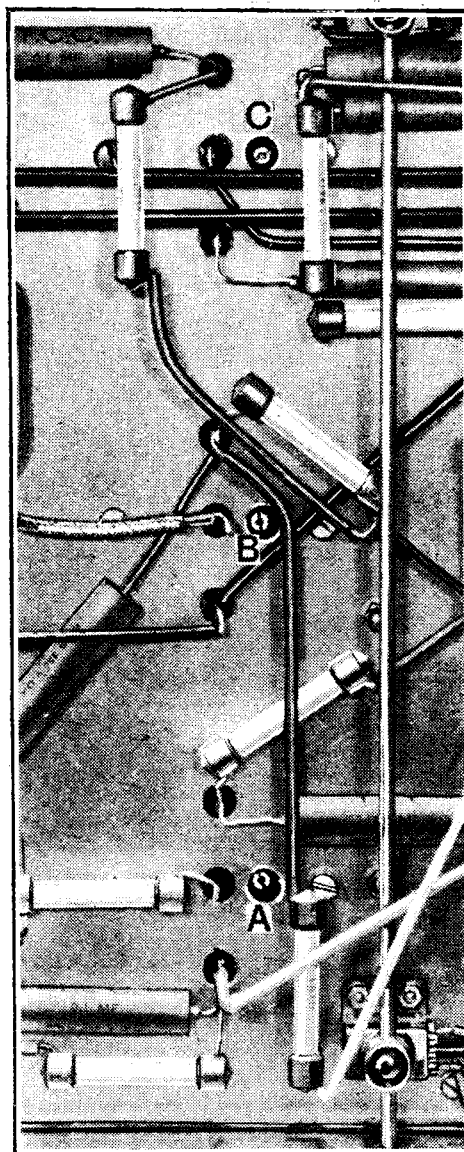

In this view of the receiver the secondary IF transformer trimmers can be seen and are again lettered A, B, and C for the 1st, 2nd, and 3rd transformers.

length station and readjust C3 and C7.

On the long waveband, set the tuning dial to receive Droitwich and adjust C12 for maximum volume from this station. Then if possible find a lower wavelength station, such as Oslo, and adjust C12 while rocking the tuning dial for the best combination of settings. C14 is then adjusted in the same way, but on Huizen; as already explained, however, this last adjustment is usually unnecessary.

Before concluding the discussion on the adjustment, a few remarks about the tuning indicator may be advisable. The values assigned to the different components have been chosen to give good indication, and no change should be needed with normal tubes. When the set is tuned to no signal the glow should extend about one-half inch up the tube, and it should fill the tube

when the set is tuned to the local station. If the glow be too great the voltage drop across R22 is not enough, and the value of this resistance should be increased. On the other hand, a reduction of this resistance is called for if the glow is not great enough.

Turning now to the question of the performance, this should be of the same order as that obtained from the original receiver, and an indication of the performance to be expected, therefore, is best given by describing the results obtained from a test on the original set. The quality of reproduction reached a very high standard with the selectivity control set for low selectivity. The measured frequency response of the receiver showed a falling characteristic at the highest audible frequencies, but

A full-size blue print of the combined wiring diagrams of the receiver and power units is available from the Publishers, Dorset House, Stamford Street, London, S.E.1. Price 1s. 6d. post free

this is automatically corrected by the rising response obtained by the combination of the loud speaker and the pentode output valve. The result is that frequencies as high as 8,000 c/s are adequately reproduced. With this degree of selectivity, many of the stronger Continental stations can be received well in daylight, but at night a higher degree of selectivity becomes necessary for the reception of those stations which have neighbours of equal or greater strength.

As the selectivity is increased the sensitivity rises slightly and then starts to decrease, and the highest selectivity is accompanied by a considerable drop in sensitivity. The initial sensitivity, however, is so high that this is unimportant, and the effect is barely noticeable, for AVC takes up the variations in volume which it would otherwise cause. With the selectivity nearly at its maximum it has proved easily possible to receive the Deutschlandsender in daylight when both Droitwich and Radio-Paris are working. No intelligible modulation interference was found in the tests, but sideband splash prevented the enjoyment of music, although speech could be followed with ease. On reducing the selectivity the programme was completely swamped by Droitwich. At all points in the range the selectivity proved adequate for distant reception and could be reduced when interference permitted to allow of a very high standard of quality being obtained. The sensitivity proved higher than is necessary for most purposes when a good aerial is used, but

VALVE VOLTAGES AND CURRENTS.

Valve.	Anode Volts.	Screen Volts.	Grid Volts.	Anode Current.	Screen Current.
HF VMP4G ..	210	110	- 4.0	mA.	mA.
FC X41, hex. ..	256	90	- 4.0	4.0	1.0
osc. ..	120	—	—	0.75	0.6
1st IF VMP4G ..	225	110	- 4.0	4.5	—
2nd IF WD40..	210	110	- 4.0	2.5	1.8
LF MHD4 ..	120 to anode	—	- 1.3	3.5	2.5
	50 to cathode			0.65	—
Out. N41 ..	250	263	- 3.9	32.0	8.0

The 1936 Monodial AC Super—

the reserve of power which it gave proved its worth in enabling the AVC system to function as a true anti-fading device.

On every station giving an adequate signal to external noise ratio for enjoyable reception, internally generated noise proved negligible; valve hiss and mains hum were inaudible. During the tests local interference was exceptionally severe,

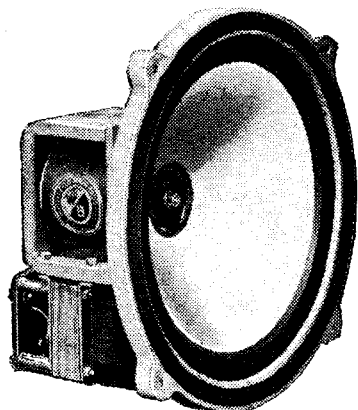

The W.B. Type EM/W loud speaker specified.

being perhaps a hundred times as great as in the average house, and amply demonstrated the value of QAVC. Without this fitting the noise while tuning was intolerable unless the manual volume control was kept at a very low level. With the muting valve in circuit, however, complete silence was secured between stations, save for occasional clicks when an extra strong pulse of interference momentarily released the detector. No aurally detectable difference in the quality could be found on any worth-while station, whether the muting were operative or not, and in normal operation the risk of distortion on weak signals is less, for muting can safely be adjusted to function on weaker signals. In order to avoid misconception it may be as well to point out clearly that the muting circuit only eliminates noise while tuning, in fact, when the set is not tuned to a signal. When the set is tuned to a station the muting circuit does nothing to reduce noise of any kind.

The manual volume control functioned smoothly and gave an entirely adequate range of control. It functions on radio and gramophone, but owing to its high resistance and the fact that a pentode output valve is used it may prove necessary to shunt the pick-up terminals with a resistance in order to prevent excessively high-pitched reproduction. The value should be found by trial and will depend upon the

pick-up employed; it will usually lie between 50,000 ohms and 0.25 megohm, however. It should be remembered that the pick-up terminals are about 50 volts above earth potential, so that care should be taken to avoid a short-circuit to earth.

It is regretted that an error occurred in both the circuit diagram and list of parts in last week's issue. The T.C.C. Type 250 0.1 mfd. tubular condenser C was omitted. This condenser is joined between the heater of the HF valve and the chassis, and is shown on the wiring diagram in this article.

New Rola Loud Speaker

A LOUD SPEAKER has been submitted for test by the British Rola Co., Ltd., of Minerva Road, Park Royal, London, N.W.10, as being specially suitable for *The Wireless World* 1936 Monodial AC Super. It is of massive construction and provided with a field winding having a resistance of 1,250 ohms, and so suitable for energising from the mains equipment. The transformer included is of suitable ratio for matching the N41 valve.

The cone is of the corrugated type with a free suspension, while the centring device gives a minimum of constraint to its movement. On test, the speaker functioned well, the sensitivity being high and the reproduction free from noticeable resonances, while both bass and treble were well maintained.

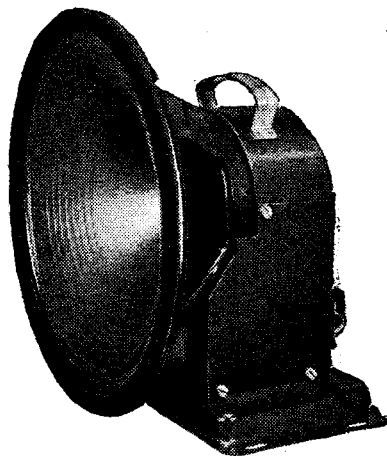

The Rola G.12 loud speaker.

It can confidently be recommended for use with the 1936 Monodial AC Super, and its construction is so robust that it should give trouble-free service over a long period. It is priced at £5 17s. 6d.

1936 Monodial Components

The Bryce smoothing choke for *The Wireless World* 1936 Monodial AC Super is shown on the left and the mains transformer in the centre.

The components are well built and the transformer is fitted with leading out wires. The Sound Sales choke for this set is shown on the right. It is ruggedly constructed and has an inductance of 10 H. with a resistance of 120 ohms, and will carry 120 mA.

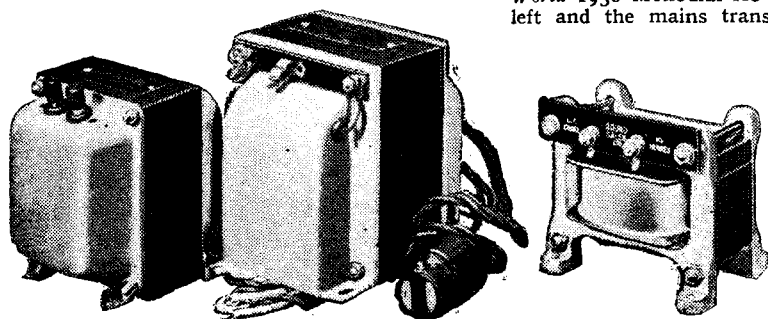
**DISTANT
RECEPTION NOTES**

KOOTWIJK, which is at present transmitting the Hilversum programmes, now declares itself officially to be using an output of 150 kilowatts. Since the figure used to be 50, one gathers that the full available power was not used formerly for the transmission of broadcast programmes. The station is very strongly received and there is no background interference from Brasov, though the latter is reported to be conducting tests. No solution of the problem of finding separate wavelengths for these two big stations seems to be in sight, but it is quite certain that something will have to be done when Brasov comes into full operation, for two 150 kilowatt stations cannot possibly share a channel without dire effects to both transmissions.

One of the most curious stations on the long wave band is the Finnish Lahti. Though this station has been using 40 kilowatts for some time now, it is very rarely heard in this country, except, possibly, in some parts of Scotland and north-eastern England. Nowadays it is overshadowed by the 500 kilowatt Moscow, whose channel is but 8 kilocycles away and it is uncomfortably near Kootwijk, the separation being no more than 6 kilocycles. One would therefore expect to hear it only at times when both of these stations were silent. But some time ago it was pretty clear of other big stations, and, even so, one found it very difficult to receive. I don't think I have logged it more than a dozen times all told and reception has never been better than weak.

The Portuguese National station at Lisbon, which has been in operation experimentally since the end of last year, was opened officially on August 1st. Working as it does on a wavelength of 476.9 metres, its 20 kilowatts would be amply sufficient to provide good reception in this country if it had a channel to itself. Unfortunately it has to share one with both Cairo and Trondelag. The Egyptian station would probably not cause much trouble, but the Norwegian certainly does, and I am afraid that Lisbon is hardly likely to be received clear of interference until after 11 p.m. Norwegian stations close down at that hour on most nights, but the Portuguese, like the Spanish, go late to bed, and I expect that Lisbon will come through well towards midnight.

M. Mandel, the French Minister of Posts and Telegraphs, has been making his presence felt more and more amongst the rather unruly French stations for some little time. Radio Vitus is one of the latest to receive an official spanking. Owing to the interference which it caused with reception in Paris it has been ordered to close down and remove itself to Romainville.

It is interesting to read that the International Broadcasting Union is endeavouring to arrange a World Broadcasting Conference for next year. With the big increases in output power that have taken place in the last year or two, broadcasting tends more and more to become a world rather than a continental problem. Heterodynes at ranges of 2,000 or 3,000 miles are by no means unknown during the darker months.

D. EXER.

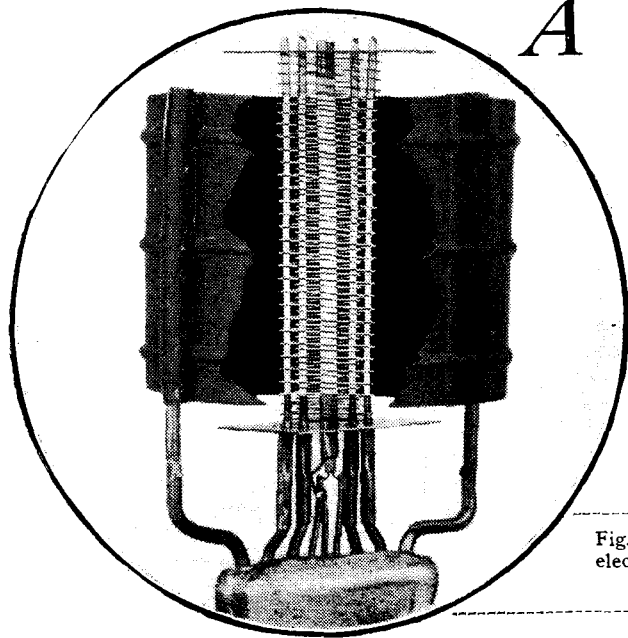

Fig. 1.—Illustration of the electrodes of the author's valve showing construction.

A New Power Output Valve

Embodying Interesting Principles in Design

By J. H. OWEN HARRIES

IN this article the designer describes the effect of applying a new principle to the construction of a power valve which is that if the anode of a multigrad valve is spaced from the outer grid at a certain "critical distance" special characteristics are obtained.

A NEW principle is employed in the design of multigrad power output valves which have just been introduced.

The electrodes of one of the new valves are illustrated in Fig. 1, the anode being cut away to show the interior. The electrode assembly is very simple; it consists merely of a cathode, an anode, and two grids. The novelty lies in the dimensions of the space between the anode and the outer grid. It has been found that if the anode of a multigrad valve is spaced from the outer grid at a certain "critical dis-

tance," special characteristics are obtained.

Spacing the anode at the critical distance avoids the necessity for a suppressor grid or any equivalent structure, such as is used in pentode valves. The undesired retrograde passage of secondary radiation is prevented.

Fig. 2 (a) and (b) show the characteristics of two of the new valves, and, opposite these characteristics, in Fig. 3 (a) and (b) are those of precisely equivalent commercial pentode valves.

The "turnover" or "knee" of the new

valves is sharper and farther to the left than with the pentodes. Therefore the power output is greater, and the working dynamic input/output characteristics (shown dotted) do not curve over at the top, as with the pentodes, but remain straight.

The most important difference is that, in consequence, the individual grid voltage lines on the anode characteristics of the new valves are straight and of constant slope from the knee upwards. Those of the pentodes are continuously curved, and the anode impedance and mutual conductance change substantially with the working anode voltage. In other words, the mutual conductances of the pentodes fall off at the left-hand end of the load line, whereas the mutual conductance is constant in the case of the new valves. As the amplified wave swings towards zero grid voltage it will be distorted in the case

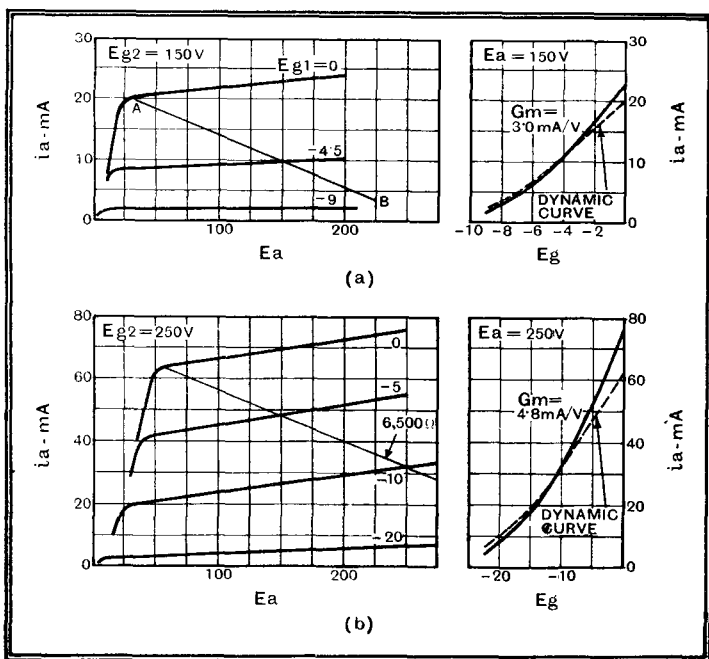

Fig. 2.—The characteristics of the new two-volt battery operated valve and of the new mains type valve.

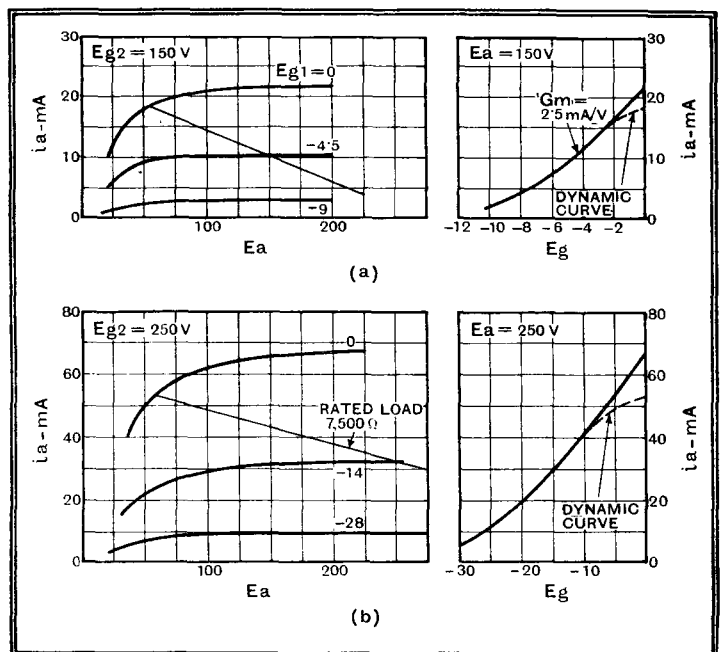

Fig. 3.—The characteristics of a two-volt pentode and a mains pentode exactly equivalent to the new valves shown in Fig. 2.

A New Power Output Valve—

of the pentode, and any overtone present in a speech or music wave will be even more seriously distorted than the main wave. Over this part of the swing, waves of different amplitude, and different parts of the same wave, will be amplified unevenly.

The impedances of the new valves are lower than those of the equivalent pentodes. That of the pentode in Fig. 3 (b)

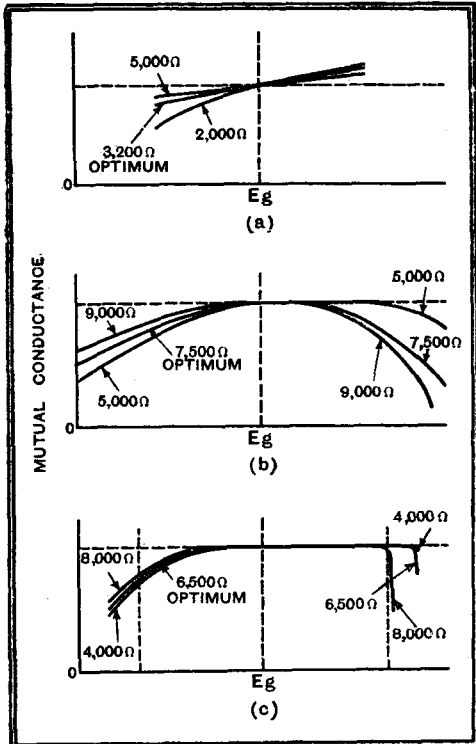

Fig. 4.—The variation of mutual conductance with input grid volts for a triode, a pentode and a Harries valve. The curves correspond to the load values marked.

is about 50,000 ohms, whilst that of the Harries valve in Fig. 2 (b) is about 16,000 ohms. In practice, the loud speakers at present available work best with a fairly low impedance. This is probably because a low impedance reduces the effects of capacitive feed-back at high audio frequencies. The mutual conductances of the new valves are appreciably higher than those of the old. Therefore the lower impedance does not reduce the sensitivity. The new valves use the same cathode size and cathode to control grid spacings as before.

Comparison of Power Outputs

The power output of the new two-volt battery valve (HY220) Fig. 2 (a) is 580 mW., and that of the corresponding pentode of Fig. 3 (a) is 400 mW. Both were measured at the same HT voltage of 150, and with the same anode current and grid bias. The increase is 1.45 times. The power output of the new valve (ACHY) Fig. 2 (b) is 2,400 mW. The sensitivity, in milliwatts per volt squared input, is 48. The power output of the equivalent mains pentode of Fig. 3 (b) is 2,000 mW., and the sensitivity is 20 mW. The most important improvement is in quality.

It is accepted that a triode valve gives an extremely satisfactory distortion level. Unfortunately, however, it is so insensitive that the extra stage of amplification it usually requires renders its use uneconomic in the great majority of receivers. In consequence, nearly all commercial receivers use pentode output valves. For instance, a typical mains triode needs 34 volts input to give two watts output. A pentode needs only 11 volts to give two watts or so; but pentodes, whilst possessing this high sensitivity, produce a peculiar so-called "pentode distortion." This distortion is due to the reduction of mutual conductance at both ends of the dynamic input/output characteristic.

The variation of mutual conductance over the full swing of grid volts is shown for a triode in Fig. 4 (a); that for a typical pentode in Fig. 4 (b); and that for one of the new valves in Fig. 4 (c). All are typical results after tests on many valves. The mutual conductance of the triode is almost constant, and the overtones of a complex speech wave are distorted but little. The pentode characteristics are so curved at all working loads that frequency-doubling modulation distortion of overtones is produced. The result is a "rough-toned" reproduction. The characteristics of the new valve are like those of a triode for normal loads and drives, and the distortion is of the same kind and degree, and is therefore as unobjectionable as that

loud speaker may be omitted. This will give a pleasant brilliance of tone and increased apparent loudness. Preferably the load is then lowered below the rated optimum value by an amount best found by trial with the loud speaker in use.

The load presented by a loud speaker to a valve is not constant, but, if not over-driven, the new valve will accommodate this variation within the straight part of the characteristics. In operation, distortion due to too high a load, and/or too high a drive, may be detected by watching the movement of a milliammeter in the anode circuit of the valve. A fall during the reception of loud passages indicates overtone distortion with any valve. As a test, the fall of anode current was observed with a sine wave drive for various power output values for both a typical commercial pentode and for the new valve of Fig. 2 (b). The same load line and operating conditions were used. With a given percentage of full drive the pentode gave two watts on a dynamometer, and the anode current dropped by 15 per cent. The Harries valve needed less drive to give two watts, and the fall in anode current was 5 per cent. The average domestic user works well below the level of two steady watts of output.

The new principle therefore results in a high sensitivity combined with the type and degree of distortion of a correctly adjusted triode, provided only that the valve is chosen to be sufficiently large to give the desired loudness.

The valves discussed are being manufactured by the High Vacuum Valve Company, of 111, Farringdon Road, London, E.C.1.

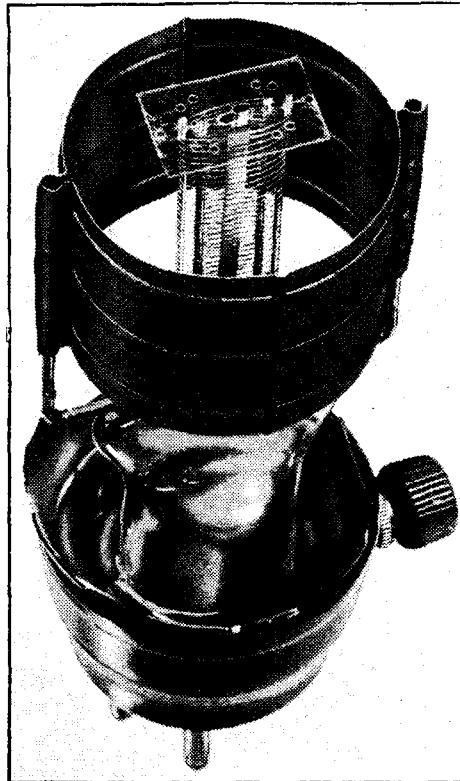

The feature of the valve is the abnormal spacing between the anode and outer grid.

of a triode. The sensitivity is of the same order as that of the pentode.

Because of the reduction of capacitive feed-back and the fact that high notes are not distorted, the conventional resistance and capacity filter circuit across the

British Standard Specification for Components for Radio-Interference Suppression Devices, No. 613, 1935.—22 pp., with many circuit diagrams. The British Standards Institution, 28, Victoria Street, London, S.W.1, 1935. Price 2s.

This publication may be said to represent the first fruits of the I.E.E. Anti-Interference Committee's labours. It deals at length with values and electrical and mechanical characteristics (largely from the "Safety First" point of view) of suppressor condensers, chokes, etc., and an appendix gives numerous diagrams of circuits which have been found satisfactory in practice for the suppression of interference from various appliances (but traction apparatus has not yet been dealt with). Problems associated with the assessment and measurement of interference on a quantitative basis are not treated, and, of course, the political aspect of the committee's activities (responsibility for suppression of interference) is entirely outside the scope of this B.S.I. specification.

It is observed that the specification provides for a very generous factor of safety in suppressor condensers, even for those to be used on domestic voltages. At first sight it might be urged that the resulting increase in cost might tend to restrict the general use of such devices, but in view of the possibly serious results of breakdowns in certain circumstances, such objections are hardly valid, especially as the condensers are generally of low value, and thus of low price in any case.

Although a very small proportion of the total space is devoted specifically to remedial measures to be applied by the wireless user, the publication should certainly be read by everyone who is seriously interested in interference suppression. H. F. S.

Events of the Week in Brief Review

Luxembourg Effect

RUSSIAN amateurs are pleading for a limit in broadcasting power. In their official journal, *Radiofront*, it is stated that the "Luxembourg effect" produced by the 500-kilowatt transmitter at Moscow is so powerful that reception of many Western European stations is impossible.

Ingenious Air Beacon

FAILURE of the aircraft warning light at the top of a high aerial mast may be difficult to rectify during the hours of darkness. At Hurlingham, near Buenos Aires, engineers have overcome the trouble by having the light on the ground in the form of a powerful beam directed perpendicularly up the centre of the lattice mast to a circular mirror at the summit.

King Leopold and Radio

KING LEOPOLD of Belgium paid his first visit to the Radio Section of the Brussels Exhibition when he visited the Alberteum Palace of Science last week. The Alberteum is a tribute to the late King Albert's services to science and industry. King Leopold was especially interested in the Marconi historical apparatus, and closely investigated the wireless section, which includes marine, broadcasting,



"TOUR DE FRANCE." The world's most gruelling cycle race provided splendid broadcasting opportunities. Here is a popular favourite, Charles Pellisier, broadcasting at one of the checks.

and echometer sounding device installations. M. Travailleux, Chairman of the Alberteum Palace, described some of Marchese Marconi's earliest experiments in Belgium in 1900.

A model of Broadcasting House, London, is shown.

Radiolympia

THE Tenth annual National Radio Exhibition will contain apparatus of £5,000,000 insurable value and will cost more than £50,000 to erect and equip. Floor space will total 50,000 square feet and the exhibition will thus be the largest of its kind in the world. The opening date is August 14th and the Show will run for ten days.

Champion Amateur

THE Blue Riband of amateur radio within the British Empire has gone to Egypt, for the winner in the annual transmitting contest of the British Empire Radio Union is Lieut. E. S. Cole, who operates station SU1EC at Cairo. Second place was secured by Mr. George Merriman, of Hong Kong, owner of station VS6AH. The event attracted entries from every corner of the Empire.

Radio Silence Zone

CERTAIN "zones of silence," where wireless reception seems impossible, are believed to exist. Such a zone is reported to exist in South Russia between Odessa and the Crimea, where all short-wave reception seems to be an impossibility.

Many London listeners, troubled by the noisy wireless sets of their neighbours, are seeking for similar blind spots.

Unrehearsed Background

WHILE a radio reporter at Flavigny-sur-Moselle was giving a running commentary on the *Tour de France* cycle contest, listeners were surprised to hear a church bell accompaniment. Actually the local church bell was calling the faithful to their devotions, the Curé having delayed Mass so that his parishioners could see the race.

R.S.G.B. Convention

THE tenth annual convention of the Radio Society of Great Britain promises to exceed in importance all previous occasions. Members will be able to visit the G.P.O. research station at Dollis Hill on August 22nd, the B.B.C. transmitters at Brookmans Park on the morning of August 23rd, and the Standard Telephones factory in the afternoon. There will be a conversation in the evening at the Florence Restaurant, W.

Saturday, August 24th, will include a business meeting in the morning, a lecture on cathode ray tubes in the afternoon, and the annual dinner at the Florence Restaurant in the evening.

Swiss People's Set ?

THE vogue of the "People's Receiver," first started by Germany, is finding support in a number of European countries. The Swiss Broadcasting Company is now considering the design of such a set in order to popularise programmes among the peasant class.

The sum of 50,000 kroner has been granted by the Norwegian

In the Intervals

INTERVAL signals have now been adopted by the French State stations. They are as follows:—

Radio-Paris: "La victoire en chantant."

Paris P.T.T.: "Si le roi, m'avait donné Paris."

Strasbourg: Minster clock chime.

Bordeaux: "Il chante."



TALKING TOURNAMENT. Ten out of 1,500 competitors will enter the last lap of the German radio reporting contest at the Berlin Show. In the picture a competitor is about to give a commentary on happenings in the Potsdamer Platz, Berlin.

Parliament for experimental work on a national receiver. Headphone reception is prescribed.

Yet Another

THE smallest wireless set in the world "always" makes its appearance in August. This year's model has been constructed by seventeen-year-old Grysha Grinberg, of Vinnitsa (Ukraine). It is stated to be two-fifths of an inch high and three-tenths of an inch in diameter. Needless to say, reception is perfect.

Helping Lame Dogs

THE suggestion that broadcasting stations should specialise in a particular class of programme has been more than once suggested in this country. France, however, appears to be the first to adopt the plan. The Eiffel Tower station is to be devoted mainly to educational and school broadcasts and for talks by societies and cultural groups.

A special course has been prepared for students who have failed to matriculate.

Montpellier: "La marche des rois."

Grenoble: "Les Allobroges."

Toulouse: "Les montagnards."

Lille: "Le P'tit Quinquin."

Lyons: "Le bon roi Dagobert."

An American Set

A "Mid-West" all-wave receiver is to be demonstrated at the meeting of the Manchester Chapter of the International Short Wave Club on August 6th at the British Legion Club, Long Street, Middleton, near Manchester.

American v. British

A REVIEW of India's import trade for the year to March 31st last, published by the Department of Overseas Trade, at 35, Old Queen Street, London, S.W.1, shows that during the year the amount of radio imports rose from £84,000 to £119,250.

During the year imports from the U.S.A. increased from £13,500 to £62,250, while those from the United Kingdom fell from £42,750 to £34,500.

Radio Data Charts—VIII

By R. T. BEATTY, M.A., B.E., D.Sc.

WHEN an iron-cored choke or transformer primary is inserted in series with the plate of a valve it carries the steady direct current which flows from the HT source of supply. This state of affairs may occur in all the stages of a radio set, though in inter-valve stages it may be avoided by the use of a parallel-feed circuit. But in the output stage it is unavoidable except when a balanced circuit is used in which DC flows in opposite directions in two coils so that the steady magnetic fluxes balance out. In power packs the filter circuits which remove ripple from the rectified AC supply also contain chokes which carry a considerable DC.

Effect of a Polarising DC

When the core is thus traversed by a steady magnetic flux in one direction its response to an alternating current through the windings is diminished, or in other words the AC permeability

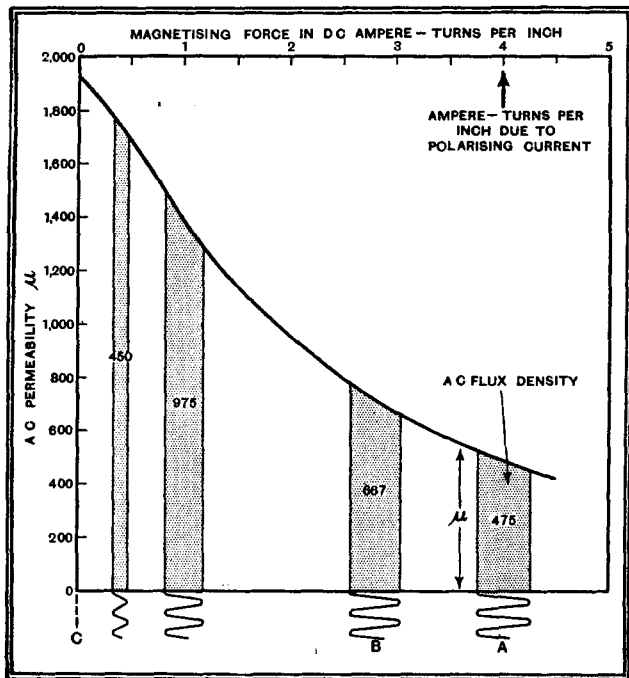

Fig. 1. Showing the fall in AC permeability when the core is polarised.

falls as shown in Fig. 1. Here the AC permeability of Radiometal is seen to diminish rapidly as the steady magnetising force increases. This magnetising force expressed in gauss is, in the case of a closed core which contains no air gap, equal to the DC ampere-turns per inch divided by 2.02.

The alternating flux density is μ times the alternating magnetising force due to a signal, and it appears that for a given signal $\mu = 1940$ when no polarising current flows, while μ falls to 475 when the magnetising force amounts to 4 amp-turns/inch. Hence the effect of DC in this case is to reduce the permeability and consequently the inductance to $475/1940 = 0.245$ of its original value.

Gapped Chokes

We might bring up the inductance to its old value by increasing the core section four times, thus obtaining the same total alternating flux, but this would result in a bulky and expensive choke, and it is simpler to improve matters by cutting a gap in the magnetic circuit.

The Design of Gapped Iron-cored Chokes and Transformers Carrying DC

The effect of a gap is to reduce the magnetising force due to a specified value of DC ampere-turns, since the ampere-turns must now drive the force not only through the iron but through the air gap as well. The effect is analogous to the decrease in current when a copper circuit connected to a specified battery is cut and a piece of resistance wire inserted in the gap: in this electrical circuit no useful purpose is served by thus diminishing the current, but in our magnetic circuit the reduced magnetising force is associated with a higher AC permeability, which is an advantage, since it gives more alternating flux for any given value of alternating magnetising force.

But at the same time we must remember that a ripple imposed on the ampere-turns now gives rise to less ripple in the magnetising force, so that it is not yet evident that the ripple in the flux density will increase when a gap is inserted. In fact, the latter ripple is the product of two quantities, one of which is increasing and the other decreasing, and we have yet to show that any improvement is effected.

Fig. 1 makes the matter clear. In a closed core of Radiometal when the DC ampere-turns/inch amount to 4 as shown by the arrow, the corresponding AC permeability is 475. Now superpose a sinusoidal signal as at A. The corresponding sinusoidal flux density is μ times the amplitude of the ripple at A, and so its peak value is the area of the shaded region which we shall call 475 units. Now introduce a gap sufficient to reduce the steady magnetising force to 2.8 ampere-turns/inch. Though the impressed ripple shown at A remains unaltered, the ripple in magnetising force sinks to a smaller value* as at B, but μ increases to 700 and the shaded area becomes 667 units, i.e., the ripple flux density is actually greater than at A.

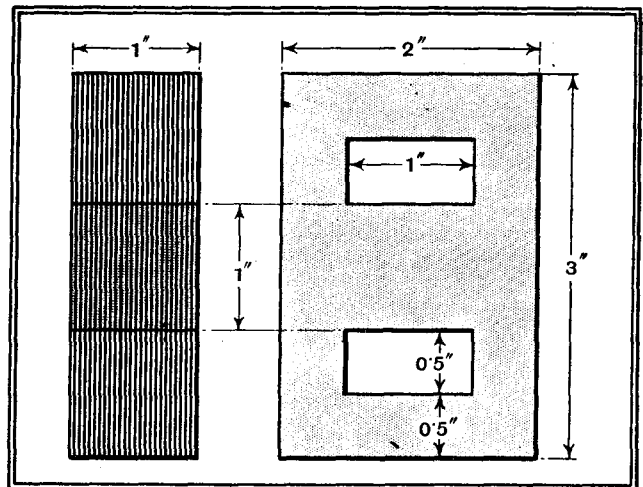
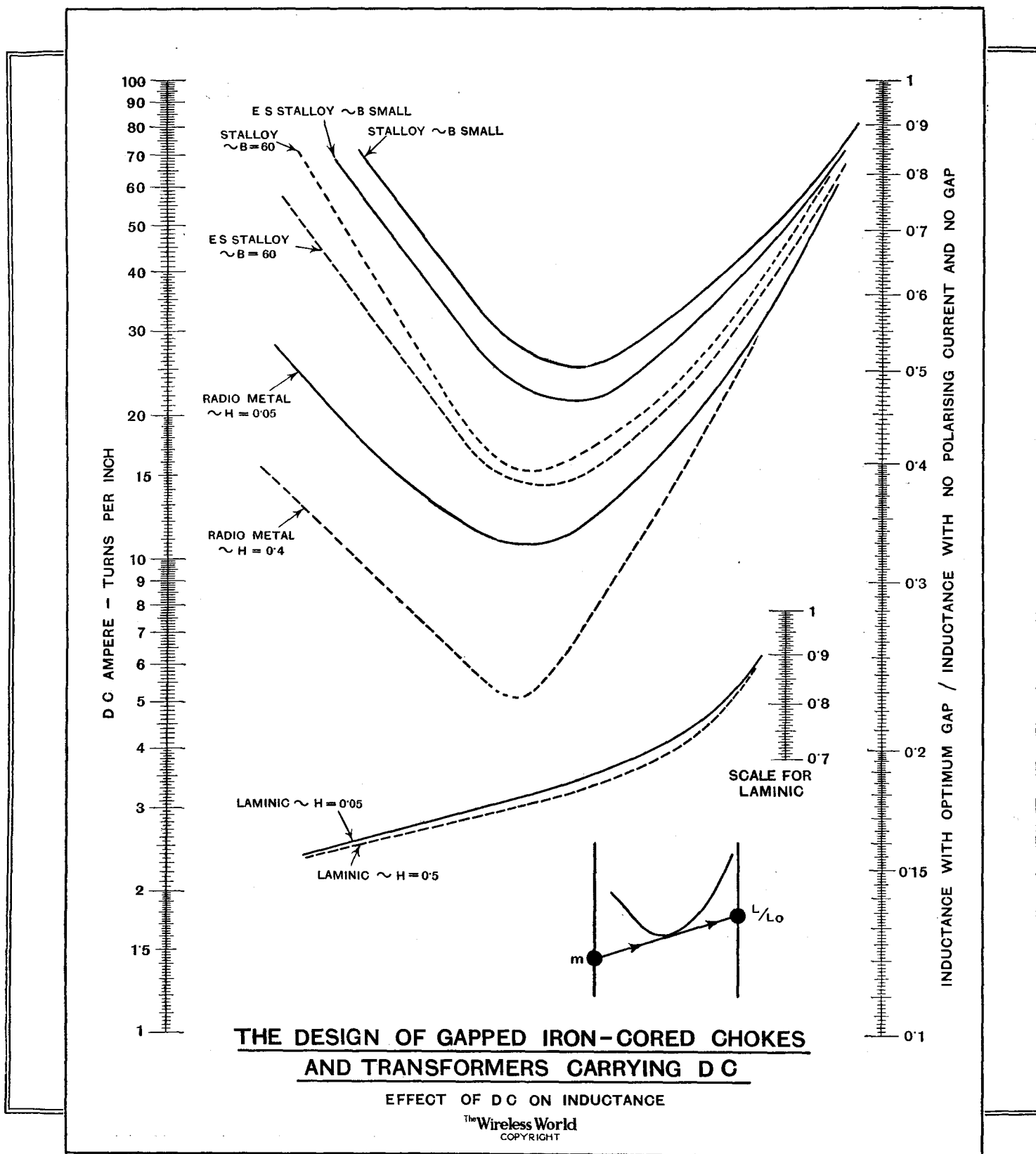

Fig. 2. Dimensions of core assumed in the worked example.

As the gap is made still larger the shaded area continues to increase and a maximum of 975 is reached at 1 amp-turn/inch. Beyond this point the amplitude of the ripple falls away more rapidly than the permeability rises, and accordingly the area diminishes. So we see that for any impressed value of DC amp-

* It can be proved that in passing from A to B the ripple falls to $1/[1 + \mu g]$ of its value at A. Here μ is the AC permeability at B and g is the gap ratio.

CHART TAKING INTO ACCOUNT EFFECT OF DC ON INDUCTANCE



turns/inch due to a fixed polarising current there is an optimum gap which gives the largest possible inductance.

Note that if no polarising current flows the ripple at A must be transferred to the origin at C, and the shaded area would now rise to the height where $\mu = 1940$. The area is now 1940 units, and we have the scheme shown in the table opposite.

The accompanying charts give the optimum gap ratio required for any choke or transformer core and also the corresponding optimum inductance. This inductance is given as a fraction of the inductance which the choke would have if the gap were filled

With and without polarising current.	With and without gap.	Inductance in arbitrary units.
No polarising current ..	No gap	1940
Polarising current .. .	Optimum gap	975
	No gap	475

CHART FOR THE DETERMINATION OF THE OPTIMUM GAP

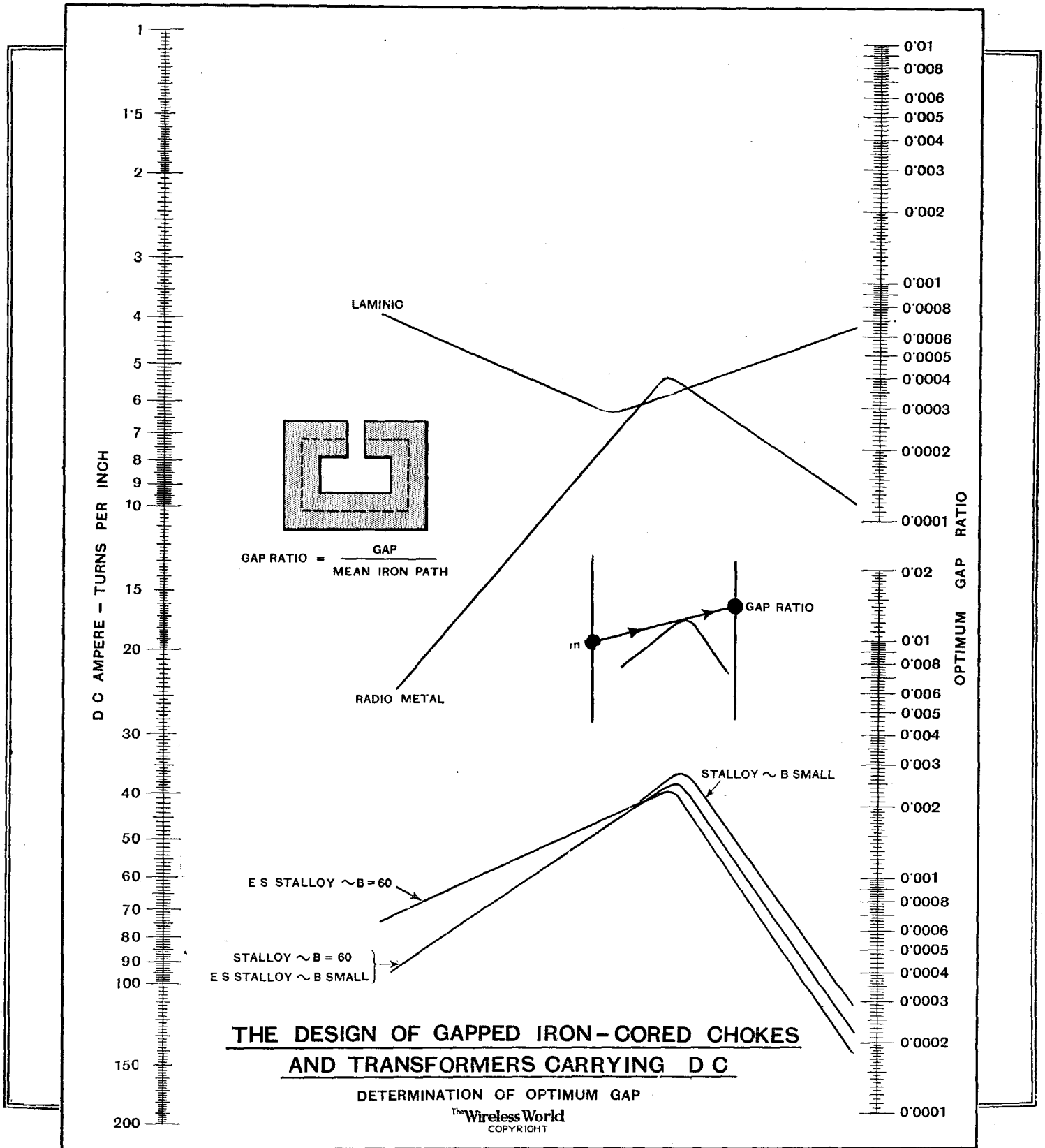

up and the polarising current cut off. The method of design of the latter type of choke has already been given,* so that the present charts tell us what margin we must allow for in the design owing to the spoiling effect of superposed DC.

Examples

1. A choke with a Stalloy core has an inductance of 12 henrys when used on AC only with low excitation. It is wound with

* The Design of Iron-cored Chokes and Transformers carrying AC only. *Wireless World*, July 26th, 1935, pp. 84-86.

524 turns per inch of mean iron path. What gap is required to give the maximum inductance when a DC current of 5 mA. is superposed; and what is the new value of inductance?

The amp-turns/inch are $5 \times 10^{-3} \times 524 = 2.62$. Hence from the first chart the inductance has fallen to 0.92 of its former value and accordingly becomes $12 \times 0.92 = 10.4$ henrys.

The gap ratio is found from the second chart; it is 0.67×10^{-3} .

2. A one-to-one output transformer with Radio-metal core is to be loaded with 35 mA. DC, passing through the primary winding. The primary inductance is to be 20 henrys. Work out a design.

Radio Data Charts—VIII—

Try the core shown in Fig. 2 and use No. 36 enamelled wire. From winding tables turns/inch²=13,500. Hence, since area of window=0.5 sq. in., and only half this area is occupied by the primary, the total primary turns=13,500 × 0.5 × 0.5=3,375. Mean iron path=5 inches. Hence turns/inch (theoretical)=3,375/5=675. Allowing 10% for spacing, former, etc., Turns/inch (actual)=n=675 × 0.9=607. Volume of iron, allowing 10% for thickness of insulation=V=5 × 1 × 0.9=4.5 cubic ins.

Hence from a previous chart,* taking the case of low AC excitation (H=0.05), we find the inductance when no polarising current flows: it amounts to 100 henrys.

We must now find the effect of the polarising current.

DC amp-turns/inch=35 × 10⁻³ × 607=21.5.

From the first chart the corresponding inductance ratio, when the optimum gap is used, is 0.22.

Hence actual inductance=100 × 0.22=22 henrys.

And from the second chart the gap ratio is 0.00135.

Hence gap = 0.00135 × 5 = 0.00675 inch.

* The Design of Iron-cored Chokes and Transformers carrying AC only. *Wireless World*, July 26th, 1935, pp. 84-86.

Random Radiations

By "DIALLIST"

Police Wireless

ONE of the curiosities of this country is that we have no national police force. Every county and city has its own police which are free, within certain limitations, to conduct their affairs in the way that suits them best. One interesting result is that there is no kind of uniformity in the wireless equipment of police forces in various parts of the country. Some make little or no use of it; others, like the police of the West Riding, Nottingham and Brighton, have developed very effective systems of their own, and Scotland Yard has been using wireless for years to help in the fight against crime.

In most instances the apparatus in use has been evolved largely as the result of research and experimental work conducted by amateurs—another feather in the cap of the amateur, which is already pretty lavishly decorated. It seems to be the time now for the various police forces to put their heads together, pooling ideas and seeing whether the ideal transmitting and receiving apparatus cannot be developed for general use by the police. The Nottingham authorities have made remarkable progress, and it is interesting to learn that their apparatus has been adopted by the Swedish police in Gothenburg as the best that is to be found. Captain Popkess, the Chief Constable of Nottingham, is very proud of the working of his two-way system, which keeps patrol vans in constant touch with headquarters.

How Many Hours?

SOME very interesting letters have reached me from readers on the subject of the average number of hours in which the wireless set is in use to-day. I suggested in the note on the subject that I wrote some time ago that the old estimate of three hours daily was now a long way below the mark; all of the letters received go to confirm this statement, but they surprise me by the figures that they give. Many listeners clearly have their sets in action for 9 or 10 hours daily and I believe that the average for the whole country is nowadays much nearer 5 hours than 3. Lower running costs, ease of operation and longer programme hours have all contributed to produce this result.

Long-Lived Valves

One correspondent told me that he was still using a trio of valves purchased in 1931 and that they were in good condition though the set had been running for "something like 9 or 10 hours a day." He estimated

the total life of these valves up to date as 11,000 hours; even if we make allowances for enthusiasm they must have been working for at least 8,000 hours.

I wrote to him asking if he could possibly have characteristic curves taken so that one could see what the condition of the valves really was. His reply was to send me the valves, which I promptly tried out. One of them, a screen-grid, was completely "gone": with 100 volts on the anode, 60 on the screen-grid and no bias on the control-grid the plate current was 0.2 milliampere. I expected to find the others in much the same condition, but, to my surprise, they proved to be in working order, as the curves published herewith will show. The standard

with in this way, but the B.B.C. has shown that straight potting is possible.

Personally, I think it is a good idea, and I should like to see more of it. It may be, though, that others find these condensed versions somewhat too scrappy and would prefer something more substantial. Perhaps a quarter of an hour is rather too little, and a not so tightly potted version might be preferable.

The Too Loud Speaker

ONE recent evening I was dining in a flat in one of those huge blocks that are arising in so many parts of London nowadays. As the weather was very hot we wanted to have every possible window open to catch what breeze there was. But to do so meant having one's ears assaulted by a horrid medley of sound from loud speakers in other flats of the same building. Since the choice lay between suffocation and jarred ears, we cut short our meal in self-defence and escaped by car into the country. The over-loud loud speaker is a real nuisance, particularly in summer time, but I don't for a moment think that those who turn the volume control well over towards the maximum position realise what suffering they may be inflicting upon their neighbours. It wouldn't be so bad if all the loud speakers were reproducing the same programme. On that evening of hateful memory half a dozen must have been at work, and most of the sets operating them seemed to be tuned to different stations. I do beg of you to remember, if you have neighbours, that even a 2½-watt output has a long range on a still evening, whilst as for 20 watts . . . !

Television in America

THE Radio Corporation of America has decided to go right ahead with an experimental high-definition service, using 343 lines and 60 images a second. This should give excellent definition, though it must not be assumed that a large number of scanning lines necessarily makes for a good picture. One of the curiosities of television is that there is at present a limit to the number of lines that can be used profitably. At first sight this appears absurd. With 30 lines you have an ill-defined image of very coarse texture; increase to 180 lines and the improvement in the image is remarkable; it is better still with 240 lines. One might therefore imagine that with 480 lines results would be better still, and that 960 would give an almost perfect picture. Actually this may not be so, because our present cathode-ray tubes probably set a limit long before this.

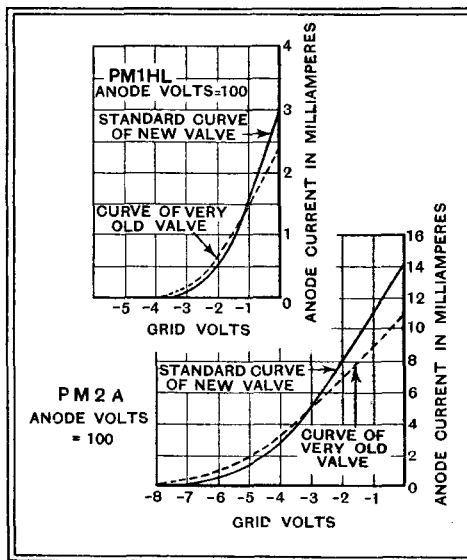

mutual conductance figure for the 1931 PM 1 H L was 1.4 milliampere/volt; this ancient specimen still has a mutual conductance of 0.9 mA/V. The figures for the PM 2 A are: standard of new valve 3.5; value for old valve 2.0. It will be seen from the curves that, despite their flatness, some kind of working could be obtained with the valves. I have seen many a valve in much worse shape after only a few hundred hours of use.

Potted Plays

I WONDER what readers thought of the B.B.C.'s recent experiment in boiling down a stage play into a fifteen-minute "précis," instead of relaying, as has been the custom heretofore, part of one act from the theatre. There is a great deal in the "potting" of plays, as Pélissier of "Follies" fame showed in years gone by. Pélissier burlesqued the plays that he dealt

UNBIASED

A Burning Question

THERE are certain items of news, like sea-serpents and giant sunflowers, which regularly turn up in the newspapers about this time of the year. The death-ray is an old favourite, and, since broadcasting began, another hardy perennial has been the "new" wireless invention which certain manufacturers nourish in their bosoms in preparation for each Olympia Show.

This year a rather unusual variation of the death-ray-and-new-wireless-invention theme has appeared. It is, in fact, a combination of death-ray and wireless. According to a writer in the daily Press, a well-known wireless research worker has been labouring long and arduously in the realms of ultra-short waves with a view to developing a piece of apparatus designed to cause discomfiture to an enemy. Needless to say, he is in the pay of "an unscrupulous foreign power"; such people invariably are, although I regret to say that I have never yet encountered any foreign power sufficiently unscrupulous to finance some of my own inventions.

This particular research worker has at last had his efforts crowned with success, and has produced, to quote the newspaper

The proud possession
of every schoolboy.



in question, "an ultra-short wave transmitter which, when directed at the flesh of any person, can cause a painful burn to appear, or, in favourable circumstances, set light to any combustible material."

I greatly fear, however, that the invention does not thrill me, either on the question of novelty or on account of its capabilities, which I do not for one moment doubt. I well recollect that in the days of my youth an ultra-short wave transmitter of this type was one of the proud possessions of every schoolboy, myself included. The wavelength used was in the neighbourhood of $\frac{1}{10,000,000}$ th metre, but we did not have sufficient financial acumen to offer it to any foreign power,

By FREE GRID

unscrupulous or otherwise, nor did we have any high-falutin' name for it, merely calling it a burning glass.

Hard Driving

WE wireless people have to put up with a lot of fatuous arguments against car-radio by members of the anti-accident league, and other spoilsports, who seem to imagine that the whole thing has been engineered by the United Undertakers' Association. It has, however, been made abundantly clear by actuarial statistics that the soporific effects of the B.B.C. programmes are a powerful counter-irritant to the over-talkative passenger, and so actually lessen the number of accidents on the road. Apart from this, the dirge-like tempo of the average B.B.C. programme is definitely conducive to much slower driving.

While the argument for and against car radio has raged furiously, however, a group of unscrupulous foreign capitalists, in their greed for gold, have introduced certain radio principles on the road in a way which constitutes a very real menace to safety.

Most of my readers, in whatever country they reside, will no doubt be familiar with the summertime sight of coach loads of American tourists hustling about the streets of all large cities. These "rubber-neck coaches," as they are usually called, are invariably provided with a guide, in addition to the driver, his duties being to stand up in the car and bawl out the principal sights through a megaphone. "On your left, ladies and gentlemen, the headquarters of the R.M.A.; on your right the National Kennel Club."

Of late years certain more enlightened coach proprietors have substituted for the megaphones a microphone and public address system. This laudable effort has inspired unscrupulous individuals with the base idea of adding to their ill-gotten gains by saving the wages of the hard-working guide. In brief, they have dispensed with him altogether, installing the microphone in front of the driver, who is thus compelled to do two jobs.

Only a few days ago I found myself in a large Continental city, an unwilling witness of the direful results of this short-

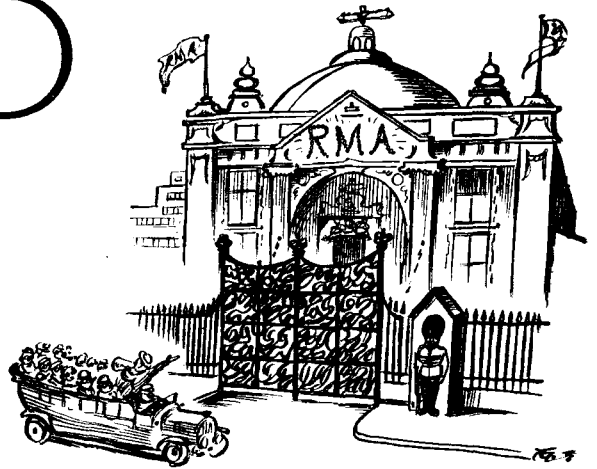

"On your left . . . the headquarters of the R.M.A."

sighted policy of greed. A great juggernaut of a coach was careering down the Unter den Linden, lopping off dogs, cats, babies, and other pedestrians in its mad career, and leaving the fairway strewn with the raw material of the undertakers' trade.

Before this sort of thing is insidiously insinuated into this country let us fight for the right to lose our lives in a manner of our own choosing instead of being arbitrarily sacrificed to this latest labour-saving device.

Potted Talks

I SEE that it has been suggested in influential quarters that now that the radiogramophone has become so ubiquitous, it would be a good thing if the B.B.C. discontinued the publication of *The Listener* (which, after all, is merely a reprint of the previous week's talks), and issued instead a gramophone record containing the speeches.

It is argued, and quite rightly, in my opinion, that anybody who wanted to give the speeches a second reading would be far better pleased if it were possible to hear the speaker's actual voice over again with all its various intonations and shades of meaning.

The only snag is the question of cost, since the making of gramophone records is apparently greater than that of printing a periodical. This could surely be quite easily overcome by letting readers make their own records with one of the new "Telecord" machines.

As regular readers of *The Wireless World* know, this is a development of the dictaphone intended for connecting to the ordinary telephone for recording conversations. It could quite obviously be just as easily attached to the ordinary wireless receiver. Its main advantage is its great economy of record material, since old records need merely be shaved—the work of a minute—to enable them to be used afresh, and this process can be repeated about a hundred times before a new record is required, although, I must admit, the initial cost is rather higher than the value of many of the talks would justify.

Micro-waves for Guiding Ships in Fog

Demonstration on a German Lake

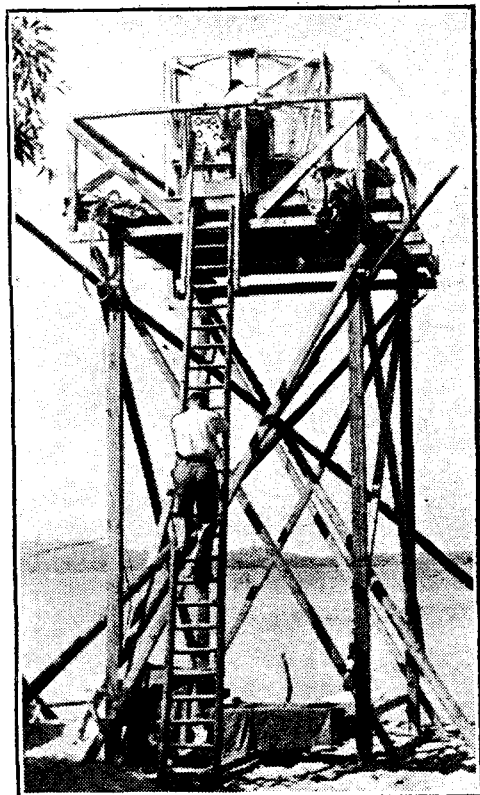

The micro-wave beacon projecting an invisible beam across the lake.

German Telefunken Company to the technical and lay Press, of its micro-wave work at its stations at Gross Ziethen and the Müggelsee. For the most striking item in the programme the visitors embarked on a lake steamboat on the Müggelsee and were shown with what astonishing ease and accuracy the navigator could follow the invisible beam projected across the lake by a micro-wave beacon on the shore. This beacon, mounted on a platform at the top of a twenty-foot scaffolding, sent out two simultaneous rays which combined to form a "leader beam" with a sharpness of about one-tenth of a degree. A "central-zero" indicating instrument on the boat

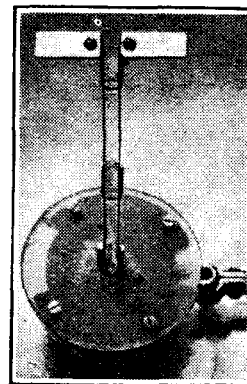

The tiny dipole aerial which is located in front of each of the concave reflectors illustrated below.

pointed straight downwards when the boat was in the line of this beam, but swung to the right or left, as the case

IN Germany, as everywhere, a great deal of research and development work has been going on during the past year or two in connection with the so-called "micro-waves"—radio waves of length from one metre downwards—"decimetre" waves, as they are often spoken of in Germany and France. This work has been going on in various countries quietly but vigorously, and from time to time the general public has had its attention drawn to some of the results—the Dover-Calais micro-wave telephone link, for instance, and the Marchese Marconi's demonstrations in Italy of the guiding of ships into harbour by means of a micro-wave beacon.

A correspondent sends us a description of a recent demonstration, given by the

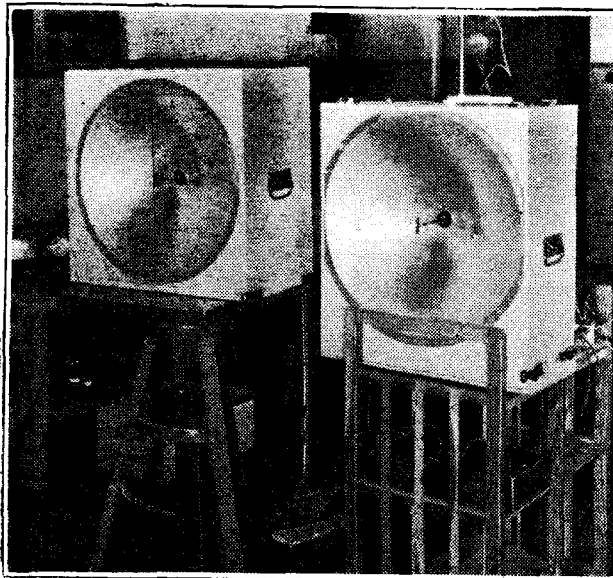

Ten-centimetre beam transmitter and receiver with reflectors.

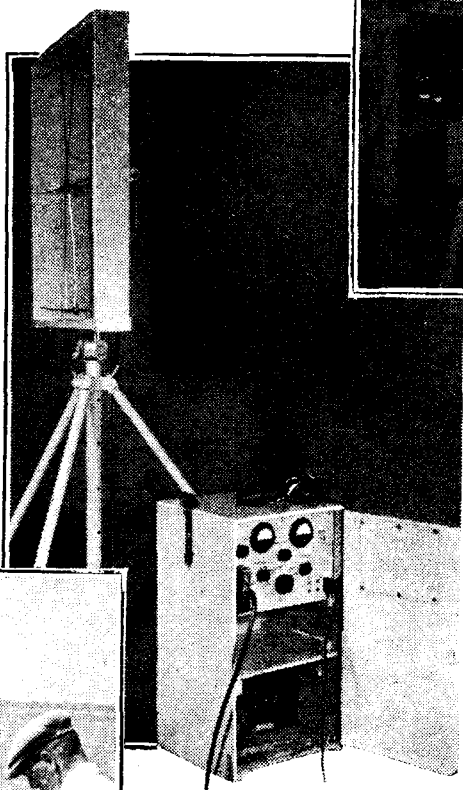

Another form of portable transmitter and receiver.

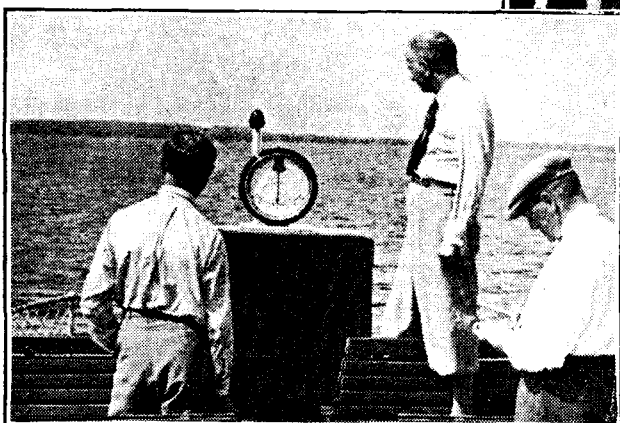

The "central-zero" indicating instrument on board.

might be, the moment the boat was steered so as to leave this line. At a distance of two or three kilometres from the beacon, we are told, a deviation from the course of only a few metres was clearly indicated.

The shortest wavelength of immediate interest for practical purposes seems to be about 10 centimetres, because waves shorter than this begin, like the still shorter waves of light, to be absorbed by mist, fog and rain. Among the other apparatus demonstrated was the very neat-looking equipment shown in one of the photographs, where the 10-centimetre Telefunken beam transmitter is seen beside the corresponding receiver. One of the tiny dipole aerials in front of each concave reflector is shown in a "close up" in another photograph. It should be possible for a boat to maintain its course automatically by adding to the visual indicator means for controlling the wheel.



THE BARD SPEAKS. A picturesque moment during the Welsh National Eisteddfod. A special Eisteddfod concert will be broadcast at 8.30 on Thursday, August 8th, the soloists being Megan Thomas (soprano), Tudor Davies (tenor) and Francis Russell (tenor), with the London Symphony Orchestra. (Inset) Mr. Lloyd George, who delivers a speech in Welsh at the Charing of the Bard Ceremony on the same day. (National, 2 p.m.)

GOOD STUFF

AUGUST BANK HOLIDAY, I often think, must be a nagging nightmare to all broadcast programme producers throughout the year. If there is one day when the people of these islands are really "let loose" it is August Bank Holiday, and to cajole them into listening to a wireless programme demands the hypnotic appeal of the rattlesnake and the all-embracing attributes of the boa constrictor.

The feat will be accomplished, I feel, in the B.B.C. programmes for Monday next. Those who tune in will flit from one seaside resort to another, beginning with Torquay (Regal Cinema), and looking in at the Spa, Whitby (Municipal Orchestra), Clacton-on-Sea, Ilfracombe, Blackpool, and Scarborough.

IN THE EVENING

BILLY COTTON'S BAND will entertain Regional listeners with dance music at 9, and, with the exception of the news, listeners will have dance music from this hour up to midnight.

By way of contrast Maurice Cole, pioneer among broadcast pianists, will be heard playing Schumann's *Fantasia Opus 17* in the National programme, and, following the News, Mark Lubbock will provide an alternative to dance music with a programme which he describes as "melodious, entertaining, but all of it good."

Harry Pepper's radio tour of concert parties round the British coasts should be a tonic for the "shut-ins" at 8 p.m. (National).

ROUND THE RESORTS

FROM Clacton will be heard "The Ocean Revue," played on the Pier. From Scarborough will come Murray Ashford's concert party, "The Bouquets." Blackpool will contribute a programme by the Arcadian Follies from the South Pier.

The microphone will then switch over to the south of England to hear "Fools in Fantasy," playing at the Gaiety Theatre, Ilfracombe. Incidentally, "Fools in Fantasy" was written and devised by Ronald Frankau, the well-known radio comedian.

COMPARISONS ARE MELODIOUS

It is in no sense of rivalry that dance orchestras are meeting one another in the series "From One Band to Another." The object is simply to enable listeners to appreciate contrasting styles side by side. To-night (Friday) at 8 Percival Mackay and his Band alternate with Bernard Monshin and his Rio Tango Orchestra. The former band specialises in straight dance music, but Bernard Monshin concentrates on rumbas and Charlestons.

MALVERN FESTIVAL CONCERT

THE first orchestral concert in the Seventh Annual Festival at Malvern will be broadcast on Sunday evening at 9, when the City of Birmingham Orchestra, conducted by Adrian Boult, plays Dvorák's Con-

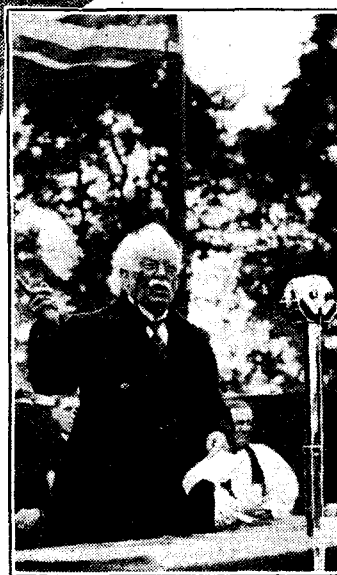

certo in B Minor and Elgar's *Cockaigne Overture*. Dr. Boult will receive a special welcome from the orchestra, of which he was official conductor for a number of years.

MUSIC OF PURCELL'S DAY

MEMBERS of the famous Dolmetsch family, who were heard recently in a broadcast programme, return to the Regional microphone at 8 on Tuesday for a concert of "Music of Purcell's Day," devised and produced by Dr. E. H. Meyer. Playing violas and recorder, Rudolph, Carl,

SALZBURG. This is not an air view of the little Austrian town but a glimpse from the neighbouring hills. A serenade concert in the Salzburg festival will be relayed at 9 o'clock on Wednesday evening (Regional).

Listeners' C

Natalie and Millicent Dolmetsch will be heard in interpretations of manuscript music by the old English masters Dr. John Blow, William Lewis, John Jenkins, and many others.

The International String Quartet will assist.

MUSIC FROM SALZBURG

LISTENERS afflicted with melancholy longings when they hear romantic music in its own romantic setting had better not tune in the Salzburg Festival relay at 9 on Wednesday next (Reg.). This is to be a Serenade Concert by the Vienna Philharmonic Orchestra playing in the Residenz in the old Austrian city, and the all-Mozart programme includes a Divertimento, March and Serenade. Bernard Paumgartner is the conductor.

Preceding the concert will be a talk on the Salzburg Festival by F. J. Nettlefold. The Festival opened on July 28th and will continue until the end of August.

LISTENERS' PROGRAMMES

It is not commonly known that listeners themselves contribute much of the material used in the Air-do-Wells programmes. Scripts and music submitted to Broadcasting House find their way into the pigeon hole of the Air-do-Wells, who transform them into pabulum for the microphone.

They are returning to St. George's Hall at 8.30 on Thursday next, August 8th, when Jack Clewes, one of the original members of the party, re-joins the cast, with Jean Colin, Claude Gardner, Ronald Hill, and Effie Atherton.

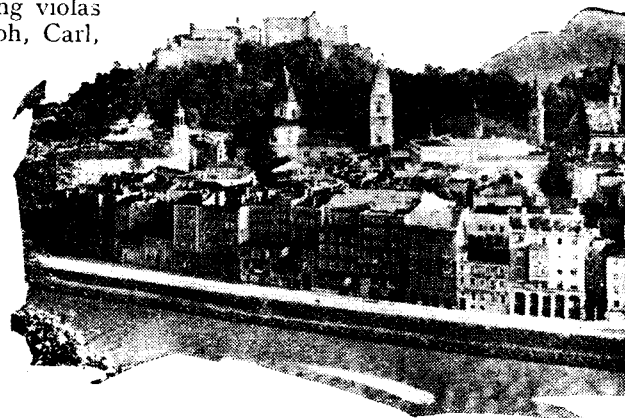

Guide for the Week

HIGHLIGHTS OF THE WEEK

FRIDAY, AUGUST 2nd.
 Nat., 7, B.B.C. Military Band. 8, "From One Band to Another."
 9, Celebrity Trio. 11.15, Harry Roy and his Band.
 Reg., 8, B.B.C. Orchestra (C), conducted by John Barbirolli. 9, "Lost Horizon"—a radio play.
Abroad.
 Radio-Paris, 8.45, French Music—a Variety Programme.

SATURDAY, AUGUST 3rd.
 Nat., Variety. "Excerpts from the Tidworth Tattoo."
 Reg., Beethoven's Thirty-Two Variations in C minor, by Iso Elinson (pianoforte). "B.B.C. Theatre Orchestra."
Abroad.
 Vienna, 9.25, "World Pictures," by the Vienna Symphony Orchestra.

SUNDAY, AUGUST 4th.
 Nat., Eugene Pini and His Tango Orchestra. "B.B.C. Singers in a Stanford programme." "Leslie Jeffries and orchestra at the Grand Hotel, Eastbourne."
 Reg., Troise and His Mandoliers. 9, Malvern Festival Concert.
Abroad.
 Stuttgart, 8, Two Hours of Summer Music.

MONDAY, AUGUST 5th.
 Nat., 8, Round the Concert Parties—Scarborough, Blackpool, Ilfracombe and Clacton. "Pianoforte Recital by Maurice Cole."
 Reg., B.B.C. Orchestra (D), conducted by Frank Bridge. "Billy Cotton's Band."
Abroad.
 Warsaw, 8.10, Polish Music by the Station Orchestra.

TUESDAY, AUGUST 6th.
 Nat., Variety. "The Celebrity Trio." "B.B.C. Orchestra (C)."
 Reg., "Music of Purcell's Day," 8.45, "The Purple Pileus," by H. G. Wells. "Medvedeff's Balalaika Orchestra."
Abroad.
 Brussels No. 1, Symphony Concert from the International Exhibition.

WEDNESDAY, AUGUST 7th.
 Nat., B.B.C. Dance Orchestra. 8, "The Purple Pileus." "B.B.C. Military Band." "B.B.C. Orchestra (C)."
 Reg., Serge Krish Septet. 9, Serenade Concert relayed from Salzburg.
Abroad.
 Kalundborg, 8.40-2 a.m., A Radio Ball.

THURSDAY, AUGUST 8th.
 Nat., Leslie Bridgewater's Harp Quintet. 8.30, Royal National Eisteddfod of Wales, from Carnarvon. "Gershom Parkinson Quintet."
 Reg., Continental Dance Music (gramophone records). 8.30, "The Air-do-Wells." "B.B.C. Dance Orchestra."
Abroad.
 Toulouse, 9, Concert Version of "The Merry Widow" (Lehár).

EISTEDDFOD

AMONG those outdoor events which make one sigh for television is the Welsh National Eisteddfod with its picturesque, not to say weird, costumes and romantic setting. The 1935 Eisteddfod takes place from August 5th to the 10th at Carnarvon, and a special concert on Thursday at 8.30 is to be broadcast (National)

Mr. Lloyd George is always present at the Charing of the Bard ceremony. The Chair is awarded each year for an ode written in strict Welsh metre, and has become the Blue Riband of Welsh literature.

Mr. Lloyd George's speech (in Welsh) will be relayed (National 2 p.m.).



OPERA AND OPERETTA

LOVERS of opera and operetta need not stint themselves this week. At 8 p.m. on Sunday Hamburg is broadcasting Johann Strauss' operetta "A Night in Venice," and on the same evening at 9 Toulouse is giving a concert version of Gounod's opera "Mirella." Two interesting concert versions from Toulouse are on Wednesday at 9.45 (Saint-Saëns' "Samson and Delilah"), and at 9 p.m. on Thursday (Lehár's "The Merry Widow").

ENGLISH PREFERRED

DANISH listeners are very keen on English fiction; indeed, they appear to prefer fiction in English rather than their native tongue, which, presumably, is reserved only for truthful statements. To-

night (Friday) at 6.25 Captain Heel is broadcasting from Kalundborg stories by A. P. Herbert and Anthony Hope.

OUTSIDE IN ORCHESTRAS

SOME 400 Boy Scouts and young musicians from the Danish Y.M.C.A. provide the monster orchestra, with vocal



(Photos by courtesy of L.N.F.R.)

ROUND THE RESORTS. Harry Pepper's radio tour of the seaside concert parties on Bank Holiday evening will include "The Bouquets" from Scarborough (left), and the "Ocean Revue," played on Clacton pier, seen above.

chorus, in the broadcast this evening from the summer camp at Aalborg, Jutland, to be relayed by Kalundborg at 8.

NOVELTY

DEUTSCHLANDSENDER, Tuesday, 8.10: "The World Passes By"—commentary relayed from a railway signal box.

WAGNER FROM VICHY

THESE are great days at Vichy. In fact, this is the *Grande Semaine*, particularly attractive for music lovers, as the main feature is the performance of the Wagner "Tetralogy," which is not being performed in Bayreuth or elsewhere in Europe this year. It is being directed in the Vichy Casino by Karl Elmendorff, leader of the Bay-

Outstanding Broadcasts at Home and Abroad

reuth Opera. The Tetralogy embraces the "Rhinegold," "Valkyrie" and "Siegfried," and the last-named will be broadcast on Monday by all the French stations. Marjorie Lawrence sings Brunnhilde.

RADIO BALL

A SIX-HOURS radio ball comes from Kalundborg on Wednesday, beginning at 8 p.m. Included in the programme are selections by Louis Preil's Orchestra, which specialises in American hot numbers.

WEEK OF DANCE MUSIC

THE programmes of all the German stations are to be devoted this week to light music and dance music. More solid material is not likely to be introduced until the opening of the Radio Exhibition, August 16th. This week, then, offers a good opportunity to hear what Germany is doing in the sphere of light entertainment. THE AUDITOR.

30-LINE TELEVISION

Baird Process Transmission. Vision, 261.1 m.; Sound, 296.6 m.

MONDAY, AUGUST 5th.
 11.15-12.0 p.m.

Billy Milton (musical comedy star); Jerry Verne (in comedy and compère); Consuelito Carmena (the Spanish dancer); Betty Frankiss (musical comedy star). Accompanist: Sydney Jerome.

WEDNESDAY, AUGUST 7th.
 11.0-11.45 p.m.

Leonie Zifado (soprano); Cleo Nordi (dances); Algeranoff (character dances); Gustave Ferrari (songs in French). At the piano: Reginald Paul.

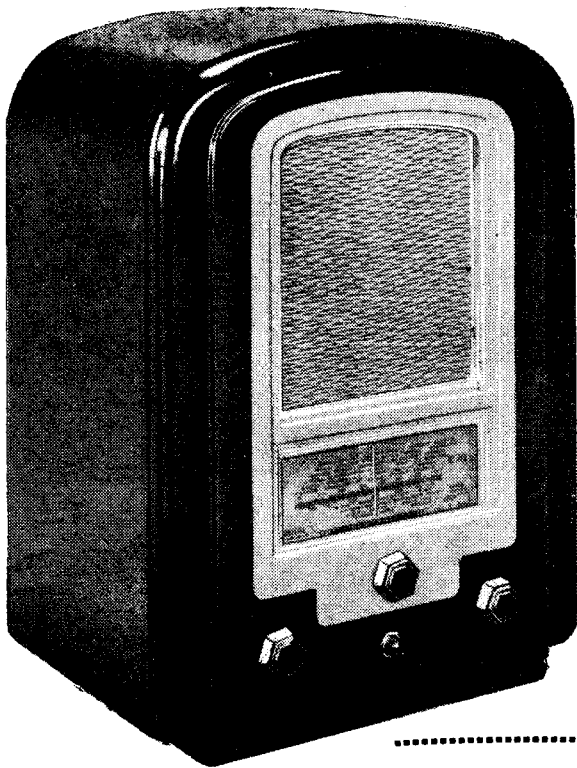

Ferranti "Nova"

FEATURES. — *Type.* — Table-model superheterodyne for AC mains. *Circuit.* — Heptode frequency-changer — var.-mu pentode IF amplifier — double-diode-pentode combined second detector and output valve. Full-wave valve rectifier. **Controls.** — (1) Tuning. (2) Volume and on-off switch. (3) Tone. (4) Waverange. **Price.** — 11 guineas. **Makers.** — Ferranti, Ltd., Moston, Manchester, 10.

A New Three-valve Superheterodyne in a Moulded Cabinet

THIS is, we believe, the first occasion on which a Ferranti receiver has appeared in a moulded bakelite cabinet, and the makers are certainly to be congratulated on the design they have chosen. The lines are simple, and the ivory inlay produces a striking contrast with the jet black body of the cabinet. As an alternative, the main body of the cabinet can be supplied with a walnut-brown finish.

In the circuit and chassis design there is a close relationship between this receiver and the "Lancaster," the principal differences being that in the lower-priced "Nova" receiver the noise-suppressor control and visual tuning indicator are omitted. The three stages in the circuit

are employed as frequency-changer, IF amplifier, and combined detector and output valve respectively. The input to the heptode frequency-changer is taken from a band-pass filter incorporating "mixed" coupling. There is also a coupling coil between the cathode circuit of the frequency-changer and the primary of the band-pass filter for the purpose of second-channel interference suppression. It is also interesting to note that the feed-back is augmented by returning the trimming condenser of the first IF transformer primary to the cathode of the frequency-changer valve.

The IF amplifier is of the variable-mu pentode type, and operates at a frequency of 125 kc/s. Both diodes of the combined

second detector and output valve are fed through the secondary of the output IF transformer, one diode being used for signal rectification and the other for supplying the negative bias for AVC. Both the frequency-changer and the IF amplifier are controlled, and a potentiometer is arranged to give a greater degree of control on the frequency-changer than on the IF amplifier. The LF component of the rectified current from the first diode is fed to the grid of the pentode section of the valve through the manual volume control, and the circuit connections for gramophone reproduction are changed by removing a flexible lead from one of the pick-up terminals at the back of the set. The volume control operates both on radio and gramophone reproduction.

Loud Speaker Arrangements

A variable resistance-capacity tone control is connected across the output circuit of the pentode. The Ferranti moving-coil loud speaker is provided with a hum-bucking coil, and terminals are provided on the secondary of the output transformer for the connection of a low-impedance extension speaker. A switch incorporated in the loud speaker unit, and accessible from the back of the set, enables the internal unit to be disconnected if desired. HT current is derived from a directly heated full-wave rectifier, and is smoothed by the loud speaker field in conjunction with two large dry electrolytic condensers. An HF by-pass condenser is connected between one side of the mains and earth, and a small condenser to the other main may be used as a mains aerial connection.

The chassis is soundly constructed, and is fitted with the Ferranti type of tuning scale in which the settings of all the controls are indicated by subsidiary pointers. The con-

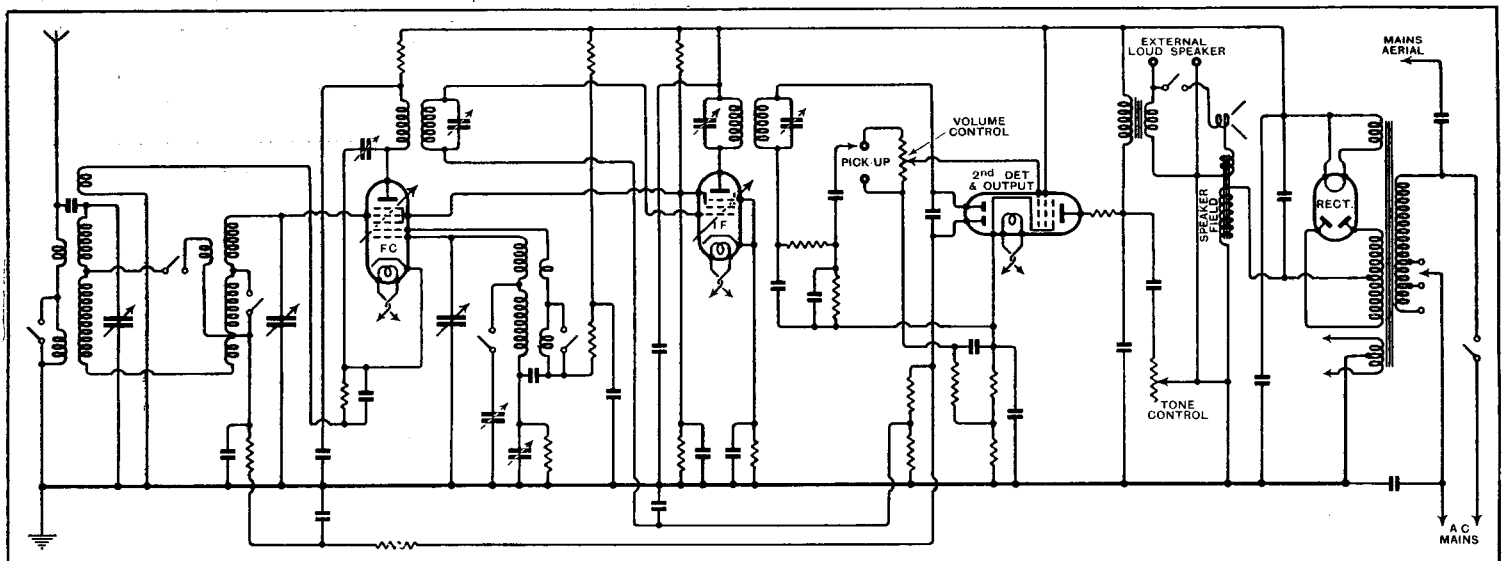

Complete circuit diagram. An image suppressor circuit is included in the input band-pass filter, which employs "mixed" coupling.

Ferranti "Nova"—

trols, and the waverange switch in particular, are unusually smooth in action. The latter switch is of a simplified rotary type with silver contacts, and occupies much less space than the ganged control with a long spindle, which is frequently adopted. Another point of interest is that the rectifier valve is mounted on top of

about one-third from the "high" position side-band interference from Droitwich and Radio-Paris was negligible. This, in our opinion, does not result in any sacrifice of good quality, for there is, if anything, a surplus of high-frequency response in the quality of reproduction which was just corrected by turning the tone control down to the position indicated.

To sum up the Ferranti "Nova," the receiver has a surprisingly good performance in the matter of range and selectivity having regard to the fact that only three valves, albeit of the multiple-purpose type, are employed in the circuit. The reproduction has a clear and bold quality which in some way seems to be in keeping with the appearance of the cabinet itself.

The receiver is also available in universal AC/DC form at 11½ guineas.

Wharfedale New "Bronze" Speaker

IN its latest form this unit is fitted with a redesigned one-piece nickel aluminium magnet, but an even more important change in the design is the adoption of an exponential cone, a special moulding which in section shows curved instead of straight sides. It is claimed for this form of construction that there is wider radiation of sound and that concentration of the high frequencies in a single resonance—a common fault in straight-sided cones—is eliminated.

We have had the opportunity of making a preliminary aural test on this speaker and can confirm that there is practically no focusing of the high frequencies in a beam parallel with the axis of the cone. Further, the high-frequency response is distributed over a much wider range than usual, and there is no serious resonance in the region of 2,000 to 3,000 cycles. The output is well maintained up to 5,000 or 6,000 cycles and then falls off gradually without any sharp cut-off. In our opinion not the least important feature of the performance is the remarkable bass output from so small a cone. The bass resonance is actually as low as 70 cycles, and down to this frequency there is no serious frequency doubling.

An ingenious dust cover has been designed for the new model which completely seals the gap without unduly restricting the movement of the diaphragm. The price of the new model is 35s. or 42s. 6d. with a universal output transformer. The makers are Wharfedale Wireless Works, 62, Leeds Road, Bradford.

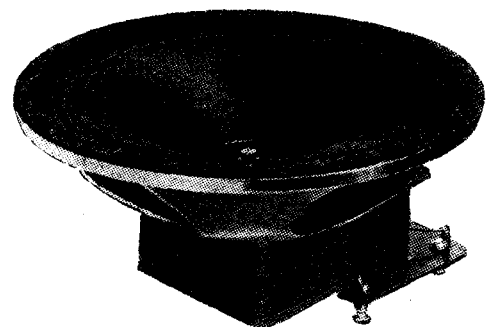

The new "Bronze" Wharfedale loud speaker is fitted with an exponentially curved cone and a new design of nickel-aluminium magnet.

Universal Test Meter

ERRATUM.—The formula given on page 60 of *The Wireless World* for July 19th last for the tapping points on the mA. shunt resistance should read as follows:—Now to find the various tapings along this resistance the formula used is $X = R \frac{I_1}{I_2}$, where X equals the shunt tapping required, R equals the resistance of the shunt, I_1 equals the current passed by the meter and shunt R, and I_2 equals current range required.

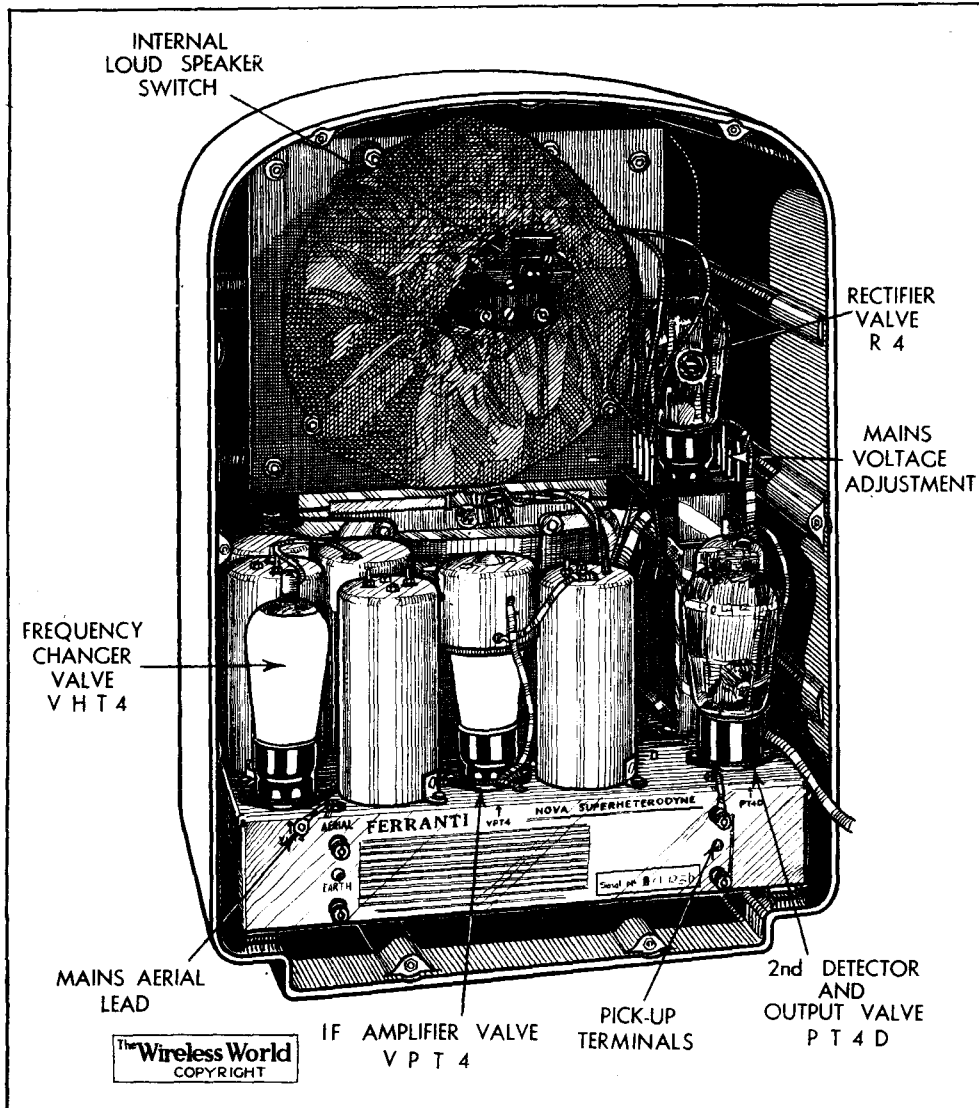

Lightness and strength are combined in the moulded bakelite cabinet. For gramophone reproduction the flexible lead attached to one of the pick-up terminals is removed.

the mains transformer, which, in addition to making a compact power unit, also facilitates service testing.

The range and volume quite belie the fact that only three valves are employed in the circuit, and the certainty with which Continental stations on both medium- and long-wave are received in daylight gives the impression of a four- or five-valve superheterodyne. The automatic volume control works well, and no difference could be detected between the volume from North Regional and Cologne when testing the receiver in Central London. Under these conditions the band-width occupied by both local stations was exactly 35 kc/s. In other words, slightly less than 1½ channels would be lost on either side of the normal setting. On long waves the volume and quality from the Deutschlandsender were definitely above the average, and with the tone control turned down by

The quality seems to be admirably suited to wood wind tone and the type of transients which are met with in pizzicato string playing. The middle register is well filled out, and by turning the tone control to the maximum low position it was revealed that if the bass response shows some tendency to concentrate in the vicinity of 85 to 90 cycles the output does not build up to the point where it is likely to produce any noticeable coloration.

The image rejector circuit incorporated in the band-pass filter is completely successful in suppressing second-channel interference on the medium waveband, but one self-generated whistle was noted on the long waverange just above 1,200 metres.

Next Set Review—
ULTRA 25

New Apparatus Reviewed

Recent Products of the Manufacturers

BENJAMIN VALVEHOLDER

A NEW chassis-mounting valveholder possessing several interesting features has been introduced recently by Benjamin Electric, Ltd., Brantwood Works, Tariff Road, Tottenham, London, N.17. This is made in 4-, 5-, 7- and 9-pin types and is of skeleton form, as used by set makers, and consists of two thin plates of bakelised material between which the heads of the sockets are clamped. The sockets are not rigidly attached to either plate, but are semi-floating, and so automatically align themselves to the valve's pins.

The sockets are oval in cross-section and split longitudinally, thus giving the necessary resilience to ensure sound contact to all the pins. Soldering tags are

Benjamin skeleton-type chassis mounting valve holder.

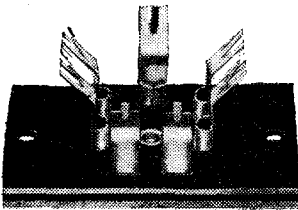

provided, and these are so shaped that a bent-in ridge bears against the valve pin, so making doubly sure of a good electrical contact.

In every sample tested the valve's pins made a perfectly sound and noiseless contact, and the valve could be rocked backwards and forwards without resulting in crackles indicative of intermittent connection.

They cost 6d. for 4-pin, 7d. for 5-pin, 9d. for 7-pin and 10d. for the 9-pin types respectively.

SOME NEW BULGIN COMPONENTS

AMONG the more recent additions to the range of components made by A. F. Bulgin and Co., Ltd., Abbey Road, Barking, Essex, is a series of fixed tubular condensers described as the Z type and designed for chassis mounting, one connection to the condenser being made by a bolt and nut, while the other terminates in a wire.

This style of mounting makes for a more rigid assembly than is usually possible with the double-ended wire type. They are made in sizes ranging from 0.00005 mfd. to 0.5 mfd., with a working voltage of 500 DC.

Bulgin midget and short-wave valveholders, 7-pin split adaptor and selection of Z type fixed condensers.

Several specimens taken at random, when measured, were found to be well within 10 per cent. of their marked values. They all withstood the rated working voltage by a very large margin, and are in every respect satisfactory.

Prices range from 6d. to 1s. 6d. each.

Split adaptors of various types have for long been made by this firm, and the latest

addition is a seven-pin model in which every pin can be isolated from its respective socket by removable links for insertion of a meter, or a gramophone pick-up where special provision is not made for its use. It has many other applications also.

This very useful component costs 3s., and it is made for Continental 6/7-pin valves as well.

We have recently carried out some experiments with an ultra-short-wave set fitted with a Bulgin 7-pin baseboard valveholder mounted on Steatite. The results were most satisfactory, so that this type is especially well suited for television sets. It is raised on short feet and has a low capacity to the chassis; the price is 2s. 3d.

A neat well-made moulded valveholder for the Hivac midget valves is obtainable from Bulgin at 1s.

VARIDEP MICROPHONE

THIS is a high-grade transverse-current microphone embodying several new and interesting features. The granular space behind the diaphragm varies in depth and in width, and it is from the first-mentioned feature that it derives its description.

It is claimed that the particular construction adopted results in the output from the microphone being proportional to the sound pressure and independent of frequency; that is to say, it has a linear characteristic. It is further claimed that the size and shape of the granular space can be arranged to give prominence to either the lower or the upper register as desired.

The shape of the granular space undoubtedly has a profound effect on the performance of the microphone, for our tests show it to be an exceptionally good specimen of the transverse-current type. Judged aurally, the output is sensibly linear throughout the entire audio scale, and over a frequency range of 20 to 15,000 c/s no noticeable resonant peaks or depressions could be found.

Orchestral reproduction is faithful, while speech is clear and crisp; sibilant sounds, admittedly a severe test for a microphone, are reproduced in a natural and true manner

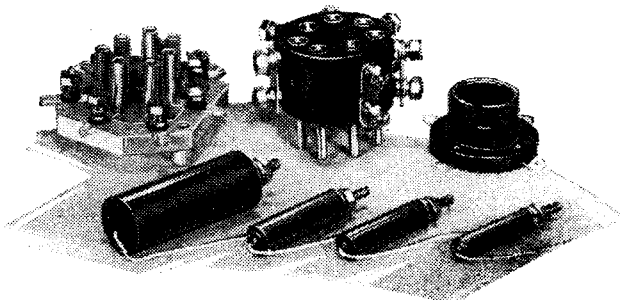

using the special astatic transformer supplied.

The Varidep microphone is undoubtedly a soundly designed instrument ideally suited to all classes of public address work. It can be commended to amateur experimenters and transmitters who require a high-grade microphone at a reasonable price.

Its output is small, though no lower than other makes of the same pattern, and a

T.M.C. Varidep transverse current carbon microphone mounted in its stand and special astatic transformer.

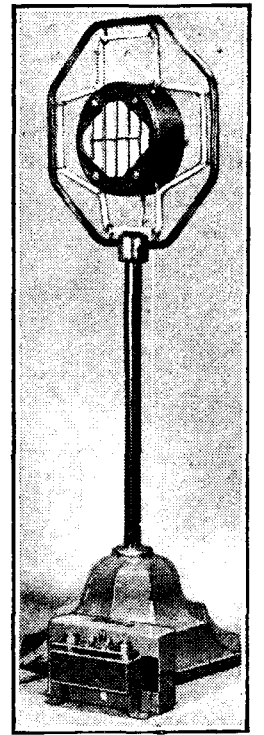

three-stage resistance-coupled amplifier will suffice for most requirements. A step-up transformer of ten to one is used, as its impedance is approximately 500 ohms. It functions satisfactorily with polarising voltages as low as six, when the current passed is about 9 mA. Twenty milliamps is the maximum recommended for prolonged operation.

The microphone is housed in a circular moulded bakelite case measuring 3½ in. in diameter, which is available finished in black, walnut or ivory; the price is £7 7s. A table-type stand in black oxydised silver costs £1 10s., and a special astatically wound transformer 19s. 6d.

The makers are the Telephone Manufacturing Co., Ltd., Hollingsworth Works, Martell Road, West Dulwich, London S.E. 21.

THE RADIO INDUSTRY

WRIGHT & WEAIRE, LTD., of 740, High Road, Tottenham, London, N.17, have now produced a series of five testing instruments comprising the following units: oscillator, meter, valve tester, frequency meter, and multi-meter. These instruments are all very moderately priced, and the last-mentioned is particularly likely to be of interest to amateurs.

The new G.E.C. car radio receiver is of the single-unit type with remote control from either the steering column or the dashboard. The usefulness of the set is enhanced by the fitting of external speaker sockets.

Another innovation is a series of G.E.C. "Black Label" HT batteries embodying developments evolved at the Wembley Research Laboratories. Prices of the new batteries are extremely moderate; for example, the 120-volt size costs 7s. 6d.

A new universal amplifying equipment (type GUB 10) has been introduced by Tannoy Products, of Canterbury Grove, W. Norwood, London, S.E. 27. The apparatus is for DC, AC or battery feed; for the latter purpose a car battery is employed. Undistorted output is rated at 10 watts.

Although the name Ferranti is a household word among all wireless people, it will come as news to most readers that until recently it was not an official trade mark. Now, however, "Ferranti," irrespective of the form or type in which it appears, has been registered as a trade mark applying to all kinds of radio apparatus, domestic electrical appliances, instruments and meters, etc.

BROADCAST

"Electrone" at Radiolympia

JOHN COMPTON'S Electrone organ, as described in *The Wireless World* of May 24th last, is to be demonstrated daily in the R.M.A. Theatre at Radiolympia, and the demonstrator will be none other than that human octopus-cum-centipede, Harold Ramsay.

Like the instrument illustrated in "W.W.," the exhibition organ will be contained in a metal box little more than four feet square, feeding loud speakers at strategic points throughout Radiolympia.

No Pipes

There are no pipes, the sounds being produced by a series of magnetic pick-ups operating on a disc engraved with sine waves and revolving at constant speed.

Sometimes, however, the speed is momentarily changed, with results that are indescribable.

The organ was broadcast a week or two ago when, as an experiment, Ramsay used it in one of his Radio Rhythm Symphony programmes. The effect was so novel that John Sharman at once began negotiations for its inclusion in his Olympia shows.

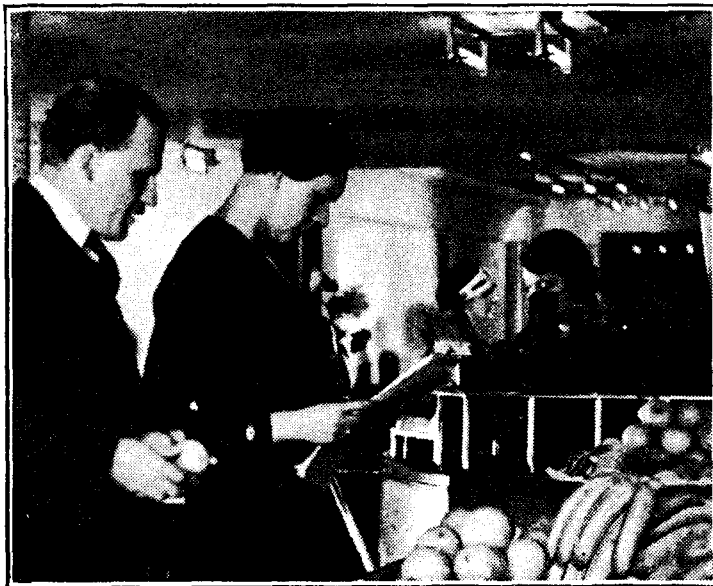

"THE VOICE OF BRITAIN" in the canteen. This glimpse of Announcer Hibberd among the rare and refreshing fruits is taken from the new film, and is characteristic of its friendly approach to the stronghold of Portland Place.

That B.B.C. Film

SIR STEPHEN TALLENTS, who will soon be impregnating the country with goodwill towards the B.B.C., took a praiseworthy step last week towards understanding the inner workings of the Corporation. He joined a Press party in seeing "B.B.C.—the Voice of Britain"

—the latest production of John Grierson and Stuart Legg, of the P.O. Film Unit.

Poem in Pictures

I fancy Sir Stephen will learn more from personal visits to Broadcasting House. This brilliant film—full of artistic imagination and technical skill—is too like a poem to give lucid help to a seeker after facts. One might as well use Wordsworth's "Excursion" as a guide to the Lake District.

Glimpses

As the film opens we hear the morning service in progress while watching clouds wheeling past variegated aerials in town and country. Then we glimpse Canon Sheppard reading the lesson in the religious studio. Fade out. We are in the B.B.C. post room. The morning mail is arriving. Background voices are uttering praises and complaints.

Now we are at a rehearsal; here are John Watt and Eric Maschwitz at an audition; this is Producer Brian Michie un-

By Our Special Correspondent

SETTING UP A "TAKE" in the effects studio at Broadcasting House. This episode is one of the most illuminating in the film.



the microphone—G. K. Chesterton, H. G. Wells, J. B. Priestley, and George Bernard Shaw. Says Mr. Shaw: "The microphone gives a man away. When I listen to a speaker on the wireless I can almost tell what he had for dinner."

This is not an instructional film. In the language of the Sunday newspapers, it is a human document.

Listen, Please

A MEMORANDUM distributed some time ago by Sir John Reith to the programme executives suggests the possibility of a new public service. Sir John requested that he be informed in advance of any particular programme to which he ought to listen.

What a service might be rendered to busy people in this way by an agency which would undertake to inform them each week of the broadcast items they could not afford to miss.

B.B.C. as Landlord

THE B.B.C. will soon, I imagine, have a place under every trade heading in the telephone Buff Book. Its latest activity is that of private landlord.

Tenants in No. 25 Portland Place, the last of the string of houses which the B.B.C. hopes to take over in order to double the size of the headquarters building, signified their willingness to move if alternative accommodation could be found.

A few days ago the Corporation bought a house on the opposite side of the street and now the said tenants are happily installed.

Two Years ?

Only No. 10, next door to Broadcasting House, still eludes

the Corporation's grasp. This is occupied by Mrs. Hawkins, who is exercising her undoubted right to remain. Not that there is extreme urgency in the matter for the B.B.C. will probably not have the money to begin the new building for at least two years.

A Whitley Council

MORE and more the idea is gaining ground at Broadcasting House that the most fitting memorial to the late Mr. J. H. Whitley, Chairman of the Board, would be the formation of a Whitley Council on behalf of the staff.

Unlike Civil Servants the B.B.C. staff have no organisation permitting them to ventilate grievances.

If a cat may look at a king, it does not follow that a clerk may talk to a Director-General. Rigid rules of seniority and precedence are observed at Broadcasting House and no one, if he values his means of livelihood, will dare to approach an official who is removed by more than one stage from his own status or grade. The caste system is very clearly defined.

Scott and the Antarctic

SOME perplexity is perceivable in the B.B.C.'s approach to Armistice Day. Shall the military aspect be preserved or would it be better to change the character of the day by concentrating on ideals of peace and goodwill?

This year, I understand, the B.B.C. will attempt a compromise by stressing the ideal of courage in times of peace. As an instance, the main programme on Armistice Night will be a Peter Cresswell production dealing with Scott's voyage to the Antarctic.

Letters to the Editor

The Editor does not hold himself responsible for the opinions of his correspondents

Daylight Stations

THE recent correspondence on the subject of "daylight stations" has prompted me to write. I have been a regular reader of *The Wireless World* for years, but this is my first letter.

Perhaps my report may be of interest. The receiver employed is a nine-valve (including rectifier) superheterodyne (Murphy A8), and the aerial is 60ft. in length and 35ft. high.

On the medium waves this is my log: Lille, Radio Normandie, Hilversum, Post Parisien, Brussels Nos. 1 and 2, Hamburg, Strasbourg, Leipzig. These are all very reliable, and come in at full loud-speaker strength. Next in order are Cologne and Stuttgart—also strong, but not so reliable. This report has been taken at two o'clock, and is based on two months' observations.

On the long waves the following stations are all very strong: Oslo, Kalundborg, Warsaw, Motala, Deutschlandsender, Radio Paris, Moscow (when Paris is closed down), Kootwijk, and, when this is not working, Kansas.

May I add a word in appreciation of the *W.W.* Quality Amplifier—a really superb job.

C. H. BLOWERS.

Ipswich.

Standard Frequency Broadcasts

I WAS much interested in reading the suggestion, under "Random Radiations," as to the B.B.C. being asked to send out a series of notes of various frequencies, to enable set owners to make tests as to the efficiency of their receivers.

I feel certain your readers would find these broadcasts of the greatest value, and sincerely trust that action may be taken in the manner you indicate.

G. FREDERICK FORWOOD.

Limpsfield, Surrey.

How Many Hours?

I READ "Diallist's" admirable "Random Radiations" of June 21st that he would welcome readers' experiences as to the number of hours daily they use their wireless sets.

I imagine my set is in use an uncommonly large number of hours daily, as I have perforce to remain in bed, and have done so for the past twenty-two months. I should imagine that a fair average of hours daily would be six—two hours in the morning, one in the afternoon, and three in the evening. It is quite often that I listen for more than an hour in the afternoon, usually on occasions when the B.B.C. are doing a relay of Twickenham, Shelsley Walsh, Wimbledon, and other "special" broadcasts of that nature.

My set is one of Marconi's Auto-Record changing radiograms, and my average listening hours daily would increase to about eight hours more (to count the time spent in listening to my own gramophone records).

My experience is that sets are in almost constant use from morning till night at the hospitals and nursing-homes where I have stayed, and I think patients are far more inclined to treat their receivers as machines to alleviate boredom than as luxuries. They have them switched on all day, whatever the nature of the programmes.

Personally, I consider that the B.B.C. programmes maintain a remarkably high general standard, and that is no mean praise when you consider that I listen to them approximately 1,900 hours per year!

I have a SW Converter coupled up to my set, and this, apart from giving me the indefinable thrill that always goes with short-wave listening, also serves to illustrate the superiority of the B.B.C.'s programmes over those of the American-sponsored type.

I hope this may be of some interest to your readers.

PETER LAFONE.

Cobham, Surrey.

Interference on SW

MAY I be permitted to trespass at some length upon these columns with a reply to the individual letters of Messrs. Parlett and Goudie, which appeared in the issue for June 14th?

Here are two cases of a grievance against telegraph interference on the short-wave broadcasts and doubtless prompted by the highest motives. Nevertheless, they are at once ill-founded and without substance when subject to technical criticism. One must first realise that the phenomenon of short-wave transmission, based as it is upon the reflecting powers of the ionised atmosphere far above the earth's surface, uniquely provides problems normally unencountered on the medium- and long-wave band, in part of which our normal broadcast services are located.

One particular manifestation of short-wave conditions is the huge difference in the relative signal intensities between two services at certain times of the day. In England, mainly from 20 to 100 metres, this is very noticeable when a distant broadcast transmission is just reaching an entertainment level. At this time some of the European beam stations are at peak strength prior to their fade-out as the skip distance rapidly increases in favour of the distant station.

At this time the *key clicks* from telegraph stations may be clearly audible over two or three hundred kilocycles of tuning on a highly selective receiver. This is due to the relatively wide band width occupied by the steep wave formation of a telegraph dot or dash, and like atmospherics or spark transmissions cannot be removed by any selective methods at present known.

It can be seen, therefore, that telegraph interference may obtain when stations are many kilocycles apart, particularly when enormous relative field strength differences are in evidence for a certain period of the day. Direct forms of interference due to heterodyning are invariably caused by image response (erroneously termed second channel response), and can only be eradicated, in a superhet, by high preselection.

Short-wave listening is an art which places such types of receivers out of the purely domestic category. The inexperienced person who is used to normal medium- and long-wave listening, and can work to a programme time-table with the flick of the switch and the turn of a knob, will not find this possible on short waves. Different wave-bands become dead at certain times of the day; 14-metre transmission requires

a route lying in brilliant daylight; 40-metre transmission requires just the reverse condition, namely, complete darkness over the route. It also happens that a certain wave-band will become dead for several days, so that unless every precaution is taken to *concentrate the transmission by a beam* upon the country to be mainly served, short-wave listening is not fully dependable. G2TD.

Accumulators for HT

WE have read with interest the views of Mr. W. J. Joughin on present-day battery receiver designs, and we observe his comments regarding HT accumulators as the apparent solution to the problem of operating the higher-power battery sets.

Whilst appreciating his various comments on the lead acid HT accumulator, we would point out that, as far as efficiency and economy are concerned, this type of HT accumulator falls far short of the ideal method of supplying high-tension current. The Milnes HT supply unit offers all the advantages of a constantly fully charged HT accumulator with none of the disadvantages such as sulphation, electrolyte creep and corrosion, and the gradual disintegration of the plates. The Milnes HT supply unit is built up of cells in which the nickel cadmium electrodes are immersed in an alkaline solution, and these electrodes or plates are virtually everlasting, due to the preserving properties of the electrolyte. A nightly charge of the unit from the LT accumulators is sufficient to restore the daily drain, the unit only taking the same amount of current from the LTs that has been drawn from the unit in the form of HT current. This results in the maximum required voltage always being available, with the result that the performance of the receiver is greatly enhanced and is not handicapped by falling voltage.

Mr. Joughin has no doubt heard of the Milnes HT supply unit, but possibly he doubts our claims being justified, but we would point out that we supply Milnes units in large quantities to the Air Ministry and the Royal Corps of Signals, which proves that the unit is not just an experiment.

As far as running costs are concerned, between 6d. and 9d. per week should cover both LT and HT requirements, even if the receiver used consumes approximately 25 milliamps of HT current.

MILNES RADIO CO., LTD.,

F. Sidler, Technical Dept.

Bingley, Yorks.

I WOULD like to add my support to the excellent suggestion put forward by your correspondent, Mr. Walter. J. Joughin, that a large number of your readers would welcome designs for more ambitious battery receivers.

Not only are there many persons who take advantage of the HT accumulator hire services, but there are also large numbers who possess the well-known nickel-iron type of HT accumulator which is capable of supplying currents of 20-25 milliampères with ease.

I, personally, would like to see a few more milliampères expended in improving quality as against increasing sensitivity and selectivity. QPP and "Class B" amplification have brought about quite a substantial gain in volume, but it would seem that real quality has yet to be achieved in so far as the battery user is concerned, and he has, up till now, had to be content with a degree of

quality inferior to that of the mains-driven receiver.

I trust that the demand for battery receivers built on more generous lines than those hitherto described will be such as to warrant the inclusion of suitable designs in the pages of your journal in the near future.

ARTHUR S. BALL.

London, S.W.8.

Date of the Wireless Show

THE holding of the annual Wireless Exhibition at Olympia during August, at a time when so many parents have to accompany their offspring on holiday, has been the subject of much criticism in the past. Various periods of the year have been suggested as being more suitable, it being argued by some that a leaf should be taken from the book of the Motor Show people and the exhibition held about six months before the beginning of the so-called season. This, in the case of wireless, would obviously mean holding it some time during March. Other critics have suggested the autumn as being a more suitable time for the show.

To all of these suggestions the Radio Manufacturers' Association have replied in effect that it is a waste of time to discuss their merits or otherwise, since Olympia has been definitely booked for August up to, and including, 1936, and that they will be compelled to hold the exhibition at the same period in future years as Olympia is fully booked up at all other periods of the year by other exhibition authorities.

By a coincidence, the Society of Motor Manufacturers and Traders have also booked Olympia for the annual Motor Show up to, and including, 1936, but it has just been announced that from 1937 onwards the annual Motor Show will be held at the vast new Exhibition Hall at present going up at Earl's Court. Presumably then, the period in the autumn, hitherto taken up by the Motor Show, will be vacant from 1937 onwards, just when the Radio Manufacturers' Association will be wanting to make fresh bookings. Is there any reason why they should not book this period or, better still, shift the venue of the Wireless Exhibition to Earl's Court, where they would probably have available a large range of dates from which to choose?

PATERFAMILIAS.

London, S.E.1.

Wide Range

IN your issue of July 12th you had an article written by "Cathode Ray" entitled "High Fidelity and Background Noise."

We should like to draw your attention to the fact that the Bell Telephone Laboratories are the Research Laboratories of the Western Electric Company, and that when dealing with the reproduction of extended frequencies in conjunction with Bell Laboratories or Western Electric this should be referred to as Wide Range.

I would point out that High Fidelity has come to be associated with a competitive concern, and I would, therefore, very much appreciate it if you would give prominence to this in your next issue.

L. F. CROCKFORD,

Publicity Supervisor, Western Electric
London, W.C.2. Co., Ltd.

Novel Frequency Generator

A Device for Obtaining Precise Audio Tones

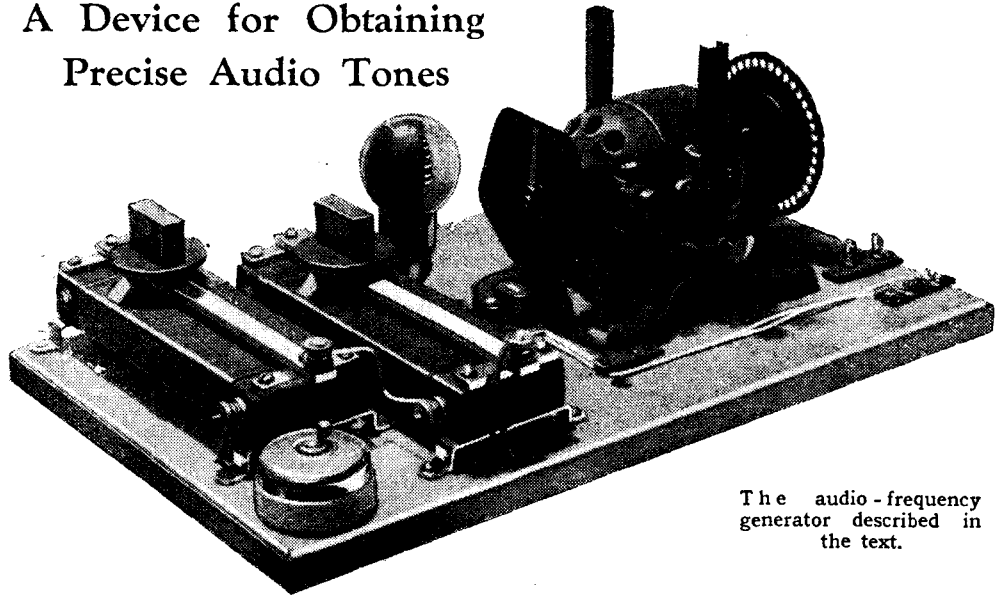

The audio-frequency generator described in the text.

THERE is no particular difficulty in generating audio frequency tones: the real problem for the experimenter is the calibration of the generator, unless one is fortunate enough to have access to standard laboratory apparatus. Those not so fortunately placed might be interested in a simple and easy-to-construct generator that will provide about seven fixed audio tones between 150 c/s and 4,000 c/s and which could be used to calibrate a valve oscillator or similar device.

The apparatus, which was demonstrated to us by Mr. Balbi, of Radio Aid, Ltd., consists of a small universal motor fitted at one end with a thin soft-iron disc about 3 1/2 in. in diameter, having 40 small holes drilled equi-distant round the edge. This is mounted between the poles of a U-shaped magnet on which is a bobbin of fine wire, the arrangement being as shown in Fig. 1.

The other end of the armature spindle carries a pentagon-shaped disc, also of

soft iron, and mounted above a magnet system as described above, only in this case an ordinary telephone earpiece is employed, the points of the pentagon rotating between the two pole-pieces carrying the bobbins.

On the outer face of the pentagon disc is a white radius line, about 1/4 in. broad, the rest of the disc being painted black. Just at one side and located so that it projects a beam of light on to the pentagon is a neon lamp, the bulb of which is painted black, but a clear area is left facing the pentagon disc. This is connected to a frequency controlled 50-c/s supply, viz., the grid system.

This disc with its white line and the neon lamp together form a stroboscope, its purpose being to fix the speed of the motor, for which purpose a control resistance is needed in its supply leads. When revolving at 100 revolutions a second a single stationary white line is seen on the disc; half the speed gives two lines, a third three, and a quarter four lines.

If the motor is revolving at 100 revolutions a second the 40-hole disc is cutting the field of the magnet 4,000 times a second and a headphone connected to the bobbin will have induced in it a 4,000 c/s note. Likewise if transferred to the bobbin on the magnet below the pentagon at the same speed of revolution the note heard will be 500 c/s. The frequencies generated are given by the simple formula $n \times 100 / l$, where n = number of holes or points on the disc, and l = the stationary lines on the stroboscope.

The apparatus could be operated from a DC supply, but this will entail replacing the stroboscope by an accurate revolution counter giving the motor speed direct in revolutions per minute. To determine the frequency the formula used will be $n \times s / \times 60$, where n is as before and s = motor speed in revolutions per minute.

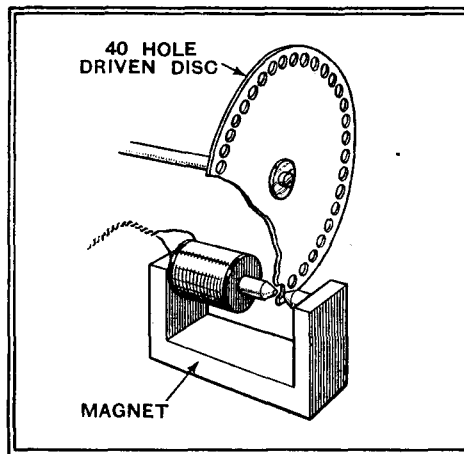

Fig. 1.—A thin metal disc mounted on the motor spindle and revolving between the poles of a magnet is used to generate the higher frequencies.

Readers' Problems

Amplified AVC Needed

AS a general rule it may be assumed that automatic volume control in any of its usual forms is applicable only to receivers which embody a fair amount of HF or IF amplification. We are therefore unable to suggest any effective and practicable scheme to the owner of a detector-LF set who wishes to fit AVC. Although various methods which at first sight would seem suitable enough for the purpose required have been suggested, all seem to suffer from serious shortcomings, or else involve so much complication that they would be quite unsuitable for a simple receiver.

Superhet Ganging

ALTHOUGH ganged variable condensers having one set of specially shaped vanes for tuning the oscillator section are almost invariably used nowadays, it is quite possible to obtain efficient single dial tuning with a ganged condenser of the ordinary or "straight" type. Admittedly, however, it is not too easy to make initial adjustments when more than one wave-band is to be covered, but a reader who proposes to make a special-purpose superheterodyne for a single band only may, we think, use his existing "straight" condenser with assurance of success. As explained in our issue of March 30th, 1932 (to which our present correspondent is referred for fuller information), the inevitable errors in alignment are so slight that they can be regarded as negligible, being no greater than the normal divergences met with in any single-control tuning system.

The circuit arrangement suggested is shown in Fig. 1; C_1 , C_2 and C_3 represent units of a three-gang condenser, the last being employed for tuning the oscillator.

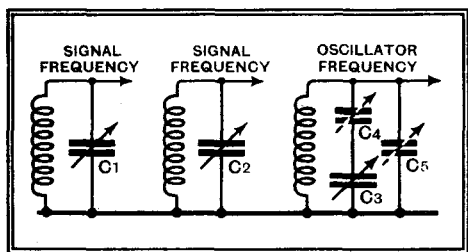

Fig. 1.—Single-knob tuning of a superheterodyne with a plain three-gang condenser.

A large padding condenser, C_4 , of the order of 0.002 mfd., is connected in series, while in parallel there is the usual trimmer, C_5 , of 40 mmfds. or more.

Screened Reaction Leads

A QUERIST who is planning a receiver with an unusual layout is anxious to know what will be the effect of screening the reaction leads. It is rightly anticipated that in view of the position of the reaction condenser and the fact that its connecting wires will be exceptionally long and will run close to other components, this precaution will be desirable.

In general, screening of reaction leads will

not have any adverse influence on the behaviour of the receiver, and so these connections may be run in metal-braided sleeving whenever it is considered desirable. On analysing the matter carefully with the help of Fig. 2, which represents a normal circuit arrangement, it will be seen that a screened connection (marked A) between the anode of the detector valve and the reaction coil acts in effect as an extra capacity between the anode and filament of the valve; in most cases a by-pass con-

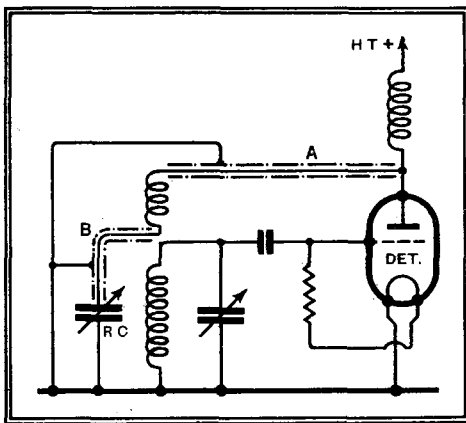

Fig. 2.—The stray capacity introduced by screening reaction leads is seldom harmful.

denser of fairly high value will already be fitted in this position, and so a little more capacity will do no harm.

With regard to the lead marked B in the diagram, with which we are mainly concerned at present, it will be evident that the capacity between the conductor and its screen is effectively in parallel with the controlling condenser RC, and so will do nothing more than add to its minimum value.

Keep Up the HT Voltage

RESULTS—of a kind—are usually obtainable from a battery-fed receiver when HT voltage has declined to a value far below normal. But this does not apply in every case; for instance, the owner of a battery superhet tells us that an unpleasant effect akin to motor-boating occurs on tuning in strong signals if HT voltage is allowed to fall by more than some 15 per cent. A further slight decline results in complete absence of signals over sections of the tuning range.

These effects are generally due to non-oscillation (or oscillations of insufficient amplitude) in the frequency changer. It is most unlikely that anything is wrong with our correspondent's set, which is of a type which requires a well-maintained HT voltage for satisfactory operation.

HF Input to Pick-up Terminals

A READER who has just bought a new set has an out-of-date "2-HF" receiver of which the high-frequency amplifier is entirely inoperative; moreover, the HF valves are defective, and it is not thought worth while to attempt a repair.

THESE columns are reserved for the publication of matter of general interest arising out of problems submitted by our readers. Readers requiring an individual reply to their technical questions by post are referred to "The Wireless World" Information Bureau, of which brief particulars, with the fee charged, are to be found at the foot of this page.

However, it is considered that the detector-LF portion of the set could still be made to serve for occasional local-station reception, and we are asked whether it would be possible for this purpose to connect an external band-pass tuning unit to the pick-up terminals.

This depends on how the radio-gramophone change-over is arranged, but if the most usual method is employed, it would not be practicable, for the reason that the built-in detector grid circuit would remain in parallel with the secondary circuit of the external band-pass filter; to obtain results it would be necessary to make an internal disconnection, or, alternatively, the grid of the valve might be isolated from the internal wiring by means of a "split grid" adaptor.

Hum Pick-up

AIR-CORED coils with a large number of turns and with quite a high value of inductance (sometimes approaching a henry) are often used for tone-correction purposes and in whistle suppressors for insertion in LF circuits.

It should be borne in mind that such coils are much more liable than the majority of other windings in a receiver to pick-up hum potentials; further, they are almost always connected in positions where such potentials will receive considerable subsequent magnification, and so cause severe audible hum in the loudspeaker.

These remarks are prompted by the experience of a correspondent who has installed an "LF" whistle suppressor. The coil of the suppressor has apparently been mounted close to the mains transformer, with the result that serious hum has been introduced.

It is recommended that a special mounting for the coil should be devised in order that it may be oriented experimentally with respect to the mains transformer. In all probability it will be possible to find a position where hum will disappear.

The Wireless World

INFORMATION BUREAU

THE service is intended primarily for readers meeting with difficulties in connection with receivers described in *The Wireless World*, or those of commercial design which from time to time are reviewed in the pages of *The Wireless World*. Every endeavour will be made to deal with queries on all wireless matters, provided that they are of such a nature that they can be dealt with satisfactorily in a letter.

Communications should be by letter to *The Wireless World* Information Bureau, Dorset House, Stamford Street, London, S.E.1, and must be accompanied by a remittance of 5s. to cover the cost of the service.

Personal interviews are not given by the technical staff, nor can technical enquiries be dealt with by telephone.

PRINCIPAL BROADCASTING STATIONS OF EUROPE

Arranged in Order of Frequency and Wavelength

(This list is included in the first issue of each month. Stations with an aerial power of 50 kW. and above in heavy type)

Station.	kc/s.	Tuning Positions.	Metres.	kW.	Station.	kc/s.	Tuning Positions.	Metres.	kW.
Kaunas (Lithuania)	155		1935	7	Graz (Austria). (Relays Vienna)	886		338.0	7
Brazov (Romania)	160		1875	150	Helsinki (Finland)	895		335.2	10
Kootwijk (Holland) (Relays Hilversum)	160		1875	150	Limoges, P.T.T. (France)	895		335.2	0.5
Lahti (Finland)	166		1807	40	Hamburg (Germany)	904		331.9	100
Moscow, No. 1, RW1 (Komintern) (U.S.S.R.)	174		1724	500	Toulouse (Radio Toulouse) (France)	913		328.6	60
Paris (Radio Paris) (France)	182		1648	80	Brno (Czechoslovakia)	922		325.4	32
Istanbul (Turkey)	187.5		1600	5	Brussels, No. 2 (Belgium). (Flemish Programme)	932		321.9	15
Berlin (Deutschlandsender Zeesen) (Germany)	191		1571	60	Algiers, P.T.T. (Radio Alger) (Algeria)	941		318.8	12
Droitwich	200		1500	150	Göteborg (Sweden). (Relays Stockholm)	941		318.8	10
Minsk, RW10 (U.S.S.R.)	208		1442	35	Breslau (Germany)	950		315.8	100
Reykjavik (Iceland)	208		1442	16	Paris (Poste Parisien) (France)	959		312.8	60
Motata (Sweden). (Relays Stockholm)	216		1389	150	Belfast	977		307.1	1
Novosibirsk, RW78 (U.S.S.R.)	217.5		1379	100	Genoa (Italy). (Relays Milan)	986		304.3	10
Warsaw, No. 1 (Raszyn) (Poland)	224		1339	120	Hilversum (Holland). (7 kW. till 6.40 p.m.)	995		301.5	20
Ankara (Turkey)	230		1304	7	Bratislava (Czechoslovakia)	1004		298.8	13.5
Luxembourg	230		1304	150	Midland Regional (Droitwich)	1013		296.2	50
Kharkov, RW20 (U.S.S.R.)	232		1293	20	Barcelona, EAJ15 (Radio Asociación) (Spain)	1022		293.5	3
Kalundborg (Denmark)	238		1261	60	Cracow (Poland)	1022		293.5	2
Leningrad, RW53 (Kolpino) (U.S.S.R.)	245		1224	100	Feisberg (Konizsberg Ermland) (Germany)	1031		291	60
Tashkent, RW11 (U.S.S.R.)	256.4		1170	25	Parade (Radio Club Portugais) (Portugal)	1031		291	5
Oslo (Norway)	260		1154	60	Leningrad, No. 2, RW70 (U.S.S.R.)	1040		288.5	10
Moscow, No. 2, RW49 (Sichekovo) (U.S.S.R.)	271		1107	100	Rennes, P.T.T. (France)	1040		288.5	40
Tiflis, RW7 (U.S.S.R.)	280		1071.4	35	Scottish National (Falkirk)	1050		285.7	50
Rostov-on-Don, RW12 (U.S.S.R.)	355		845	20	Bari (Italy)	1059		283.3	20
Budapest, No. 2 (Hungary)	359.5		834.5	20	Traspol, RW57 (U.S.S.R.)	1068		280.9	4
Sverdlovsk, RW5 (U.S.S.R.)	375		800	50	Bordeaux, P.T.T. (Lafayette) (France)	1077		278.8	30
Geneva (Switzerland). (Relays Sottens)	401		748	1.3	Zagreb (Yugoslavia)	1086		276.2	0.7
Moscow, No. 3 (RCZ) (U.S.S.R.)	401		748	100	Falun (Sweden)	1086		276.2	2
Voroneje, RW25 (U.S.S.R.)	413.5		726	10	Madrid, EAJ7 (Union Radio) (Spain)	1095		274	7
Oulu (Finland)	431		696	1.2	Madona (Latvia)	1104		271.7	50
Ufa, RW22 (U.S.S.R.)	436		688	10	Naples (Italy). (Relays Rome)	1104		271.7	1.5
Hamar (Norway) (Relays Oslo)	510.5		587.7	0.7	Moravska-Ostrava (Czechoslovakia)	1113		269.5	11.2
Innsbruck (Austria). (Relays Vienna)	519		578	1	Fécamp (Radio Normandie) (France)	1113		269.5	10
Ljubljana (Yugoslavia)	527		569.3	5	Alexandria (Egypt)	1122		267.4	0.25
Viipuri (Finland)	527		569.3	10	Newcastle	1122		267.4	1
Bolzano (Italy)	536		559.7	1	Nyiregyhaza (Hungary)	1122		267.4	6.2
Wilno (Poland)	536		559.7	16	Hörby (Sweden). (Relays Stockholm)	1131		265.3	10
Budapest, No. 1 (Hungary)	546		549.5	120	Turin, No. 1 (Italy). (Relays Milan)	1140		263.2	7
Beromünster (Switzerland)	556		539.8	100	London National (Brookmans Park)	1149		261.1	20
Athlone (Irish Free State)	565		531	60	North National (Slaitwaite)	1149		261.1	20
Palermo (Italy)	565		531	4	West National (Washford Cross)	1149		261.1	20
Stuttgart (Mühlacker) (Germany)	574		522.6	100	Kosice (Czechoslovakia). (Relays Prague)	1158		259.1	2.6
Grenoble, P.T.T. (France)	583		514.6	15	Monte Ceneri (Switzerland)	1167		257.1	15
Riga (Latvia)	583		514.6	15	Copenhagen (Denmark). (Relays Kalundborg)	1176		255.1	10
Vienna (Bisamberg) (Austria)	592		506.8	100	Kharkov, No. 2, RW4 (U.S.S.R.)	1185		253.2	10
Rabat (Radio Maroc) (Morocco)	601		499.2	25	Frankfurt (Germany)	1195		251	25
Sundsvall (Sweden). (Relays Stockholm)	601		499.2	10	Prague, No. 2 (Czechoslovakia)	1204		249.2	5
Florence (Italy). (Relays Milan)	610		491.8	20	Lille, P.T.T. (France)	1213		247.3	60
Cairo (Abu Zabal) (Egypt)	620		483.9	20	Trieste (Italy)	1222		245.5	10
Brussels, No. 1 (Belgium). (French Programme)	620		483.9	15	Gleiwitz (Germany). (Relays Breslau)	1231		243.7	5
Lisbon (Bacarena) (Portugal)	629		476.9	20	Cork (Irish Free State) (Relays Athlone)	1240		241.9	1
Trøndelag (Norway)	629		476.9	20	Juan-les-Pins (Radio Cote d'Azur) (France)	1249		240.2	2
Prague, No. 1 (Czechoslovakia)	638		470.2	120	Kuldiga (Latvia)	1258		238.5	10
Lyons, P.T.T. (La Doua) (France)	648		463	100	Rome, No. 3 (Italy)	1258		238.5	1
Cologne (Langenberg) (Germany)	658		455.9	100	San Sebastian (Spain)	1258		238.5	3
North Regional (Slaitwaite)	668		449.1	50	Nürnberg and Augsburg (Germany) (Relay Munich)	1267		238.8	2
Sottens (Radio Suisse Romande) (Switzerland)	677		443.1	25	Christiansand and Stavanger (Norway)	1276		235.1	0.5
Belgrade (Yugoslavia)	686		437.3	2.5	Dresden (Germany) (Relays Leipzig)	1285		233.5	0.25
Paris, P.T.T. (Ecole Supérieure) (France)	695		431.7	7	Aberdeen	1285		233.5	1
Stockholm (Sweden)	704		426.1	55	Austrian Relay Stations	1294		231.8	0.5
Rome, No. 1 (Italy)	713		420.8	50	Danzig. (Relays Königsberg)	1303		230.2	0.5
Kiev, RW9 (U.S.S.R.)	722		415.5	36	Swedish Relay Stations	1312		228.7	1.25
Tallinn (Estonia)	731		410.4	20	Magyarovar (Hungary)	1321		227.1	1.25
Madrid, EAJ2 (Radio España) (Spain)	731		410.4	3	German Relay Stations	1330		225.6	1.5
Munich (Germany)	740		405.4	100	Montpellier, P.T.T. (France)	1339		224	5
Marseilles, P.T.T. (France)	749		400.5	5	Lodz (Poland)	1339		224	1.7
Katowice (Poland)	758		395.8	12	Dublin (Irish Free State) (Relays Athlone)	1348		222.6	0.5
Scottish Regional (Falkirk)	767		391.1	50	Milan, No. 2 (Italy) (Relays Rome)	1348		222.6	4
Toulouse, P.T.T. (France)	776		386.8	2	Turin, No. 2 (Italy). (Relays Rome)	1357		221.1	0.2
Leipzig (Germany)	785		382.2	120	Basle and Berne (Switzerland)	1375		218.2	0.5
Barcelona, EAJ1 (Spain)	795		377.4	5	Warsaw, No. 2 (Poland)	1384		216.8	2
Lwow (Poland)	795		377.4	16	Lyons (Radio Lyons) (France)	1393		215.4	5
West Regional (Washford Cross)	804		373.1	50	Tampere (Finland)	1420		211.3	0.7
Milan (Italy)	814		368.6	50	Paris, (Radio LL) (France)	1424		210.7	0.8
Bucharest (Romania)	823		364.5	12	Béziers (France)	1429		209.9	1.5
Moscow, No. 4, RW39 (Stalina) (U.S.S.R.)	832		360.6	100	Miskole (Hungary)	1438		208.6	1.25
Berlin (Funkstunde Tegel) (Germany)	841		356.7	100	Paris (Eiffel Tower) (France)	1456		206	5
Bergen (Norway)	850		352.9	1	Pecs (Hungary)	1465		204.8	1.25
Sofia (Bulgaria)	850		352.9	1	Bournemouth	1474		203.5	1
Valencia (Spain)	850		352.9	1.5	Plymouth	1474		203.5	0.3
Simferopol, RW52 (U.S.S.R.)	859		349.2	10	International Common Wave	1492		201.1	0.2
Strasbourg, P.T.T. (France)	859		349.2	35	International Common Wave	1500		200	0.25
Poznan (Poland)	868		345.6	18	Liepāja (Latvia)	1737		178	0.1
London Regional (Brookmans Park)	877		342.1	50					

NOTE.—Since the publication of the previous list alterations have been made to the particulars of the following stations: Kootwijk (Holland), Hamar (Norway), Limoges (France), Heilsberg (Germany), Frankfurt (Germany), Dresden (Germany).

SHORT-WAVE STATIONS OF THE WORLD

Arranged in Order of Wavelength and Frequency

(N.B.—Times of Transmission given in parentheses are approximate only and represent G.M.T.)

Metres.	kc/s.	Call Sign.	Station.	Tuning Positions.	Metres.	kc/s.	Call Sign.	Station.	Tuning Positions.
84.67	3,543	CR7AA	Mozambique (E. Africa). (Mon., Thurs., Sat., 18.30 to 20.30.)		41.8	7,177	CR6AA	Lobito (Angola). (Wed., Sat. 19.30 to 21.30.)	
75.0	4,000	CT2AJ	Ponta Delgada (Azores). (Wed., Sat., 22.00 to 24.00.)		38.48	7,797	HBP	Radio Nations, Prangins (Switzerland). (Sat. 22.30 to 23.15.)	
70.2	4,273	RV15	Kharbarovsk (U.S.S.R.). (Daily 06.00 to 14.00.)		37.33	8,035	CNR	Rabat (Morocco). (Sun. 20.00 to 22.30.)	
67.11	4,470	YDB	Sourabaya (Java). (Daily 03.30 to 06.30)		36.5	8,214	HCJB	Quito (Ecuador). (Daily ex. Sun., Mon. 00.45 to 04.45, Sun. 21.45 to 01.15.)	
58.31	5,145	OK1MPT	Prague (Czechoslovakia). (Experimental)		32.88	9,134	HAT4	Budapest (Hungary). (Sat. 23.00 to 24.00.)	
51.28	5,850	YV5RMO	Maracaibo (Venezuela). (Daily, 22.00 to 02.00.)		31.8	9,428	COH	Havana (Cuba). (Daily 16.00 to 17.00, 22.00 to 23.00, 01.00 to 02.00.)	
50.42	5,950	HJ1ABE	Medellin (Colombia). (Daily, 16.30 to 18.30, Sun., Tues., Thurs., 23.30 to 03.00 also.)		31.58	9,500	PRF5	Rio de Janeiro (Brazil). (Daily 22.30 to 23.15.)	
50.26	5,969	HV1	Vatican City. (Daily 19.00 to 19.15, Sun. 10.00 also.)		31.55	9,510	GSB	Empire Broadcasting	
50.16	5,980	HIX	Santa Domingo (W. Indies). (Daily, 12.00 Sun. 00.38 also.)		31.54	9,518	VK3ME	Melbourne (Australia). (Wed. 10.00 to 11.30, Sat. 10.00 to 12.00.)	
50.0	6,000	RW59	Moscow (U.S.S.R.). (Relays No. 1 Stn.) (Daily 20.00 to 23.00.)		31.49	9,526	LKJ1	Jeløy (Norway). (Relays Oslo.) (Daily 10.00 to 13.00.)	
49.96	6,005	VE9DN	Montreal (Canada). (Daily 04.30 to 05.00)		31.48	9,530	W2XAF	Schenectady, N.Y. (U.S.A.). (Relays W.C.F.) (Daily 23.30 to 04.00, Sat. 19.00 to 22.00 also.)	
49.96	6,005	HJ3ABH	Bogotá (Colombia)		31.45	9,540	DJN	Zeesen (Germany). (Daily 08.45 to 12.15, 13.00 to 16.30, 22.15 to 03.30.)	
49.92	6,010	COC	Havana (Cuba). (Daily 21.00 to 23.00, 01.00 to 03.00, Sun. 04.30 to 06.30 also.)		31.38	9,560	DJA	Zeesen (Germany). (Daily 13.00 to 16.30, 22.15 to 02.00.)	
49.85	6,018	ZHI	Singapore (Malaya). (Mon., Wed., Thurs. 23.00 to 01.30, Sun. 03.40 to 05.10.)		31.36	9,565	VUB	Bombay (India). (Sun. 13.30 to 15.30, Wed., Thurs. Sat. 16.30 to 17.30, irregular Mon.)	
49.83	6,020	DJC	Zeesen (Germany). (Daily 22.30 to 03.30, 17.00 to 21.30.)		31.35	9,570	W1XK	Springfield, Mass. (U.S.A.). (Relays WBZ.) (Daily 12.00 to 06.00.)	
49.75	6,030	HP5B	Panama City (Central America). (Daily 17.00 to 18.00, 01.00 to 03.30.)		31.32	9,580	GSC	Empire Broadcasting	
49.75	6,030	VE9CA	Calgary (Canada). (Thurs. 14.00 to 07.00, Sun. 17.00 to 05.00.)		31.32	9,580	VK3LR	Lindhurst (Australia). (Daily ex. Sun. 08.15 to 12.30.)	
49.67	6,040	W1XAL	Boston, Mass. (U.S.A.). (Sun. 22.00 to 24.00, Wed., Fri. 00.30 to 01.45.)		31.28	9,590	W3XAU	Philadelphia, Pa. (U.S.A.). (Relays W.C.A.U.) (Daily 17.00 to 24.00.)	
49.67	6,040	PRAS	Pernambuco (Brazil). (Daily 20.00 to 00.30.)		31.28	9,590	VK2ME	Sydney (Australia). (Sun. 06.00 to 08.00, 10.00 to 14.00, 14.30 to 16.30.)	
49.59	6,050	GSA	Empire Broadcasting		31.27	9,595	HLB	Radio Nations, Prangins (Switzerland). (Sat. 22.30 to 23.15.)	
49.5	6,060	W8XAL	Cincinnati, Ohio (U.S.A.). (Daily 12.00 to 01.00, 04.00 to 06.00.)		31.13	9,637	2RO	Rome (Italy). (Tues., Thurs. Sat. 00.45 to 02.15.)	
49.5	6,060	W3XAU	Philadelphia, Pa. (U.S.A.). (Relays W.C.A.U.) (Daily 01.00 to 04.00.)		31.0	9,677	CT1CT	Lisbon (Portugal). (Thurs. 21.00 to 23.00, Sun. 12.00 to 14.00.)	
49.5	6,060	OXY	Skamlebaek (Denmark). (Relays Katundborg.) (Daily 18.00 to 24.00, Sun. 16.00 also.)		30.43	9,860	EAQ	Madrid (Spain). (Daily 22.15 to 00.30, Sat. 18.00 to 20.00 also.)	
49.42	6,070	OER2	Vienna Experimental. (Daily 14.00 to 22.00.)		29.04	10,330	ORK	Ruyselede (Belgium). (Daily 18.30 to 20.30.)	
49.4	6,072	CT1AA	Lisbon (Portugal). (Tues., Thurs. Sat. 21.30 to 24.00.)		25.6	11,720	FYA	Paris, Radio Coloniale (France). (Colonial Stn. E-W.) (Daily 00.00 to 03.00, 04.00 to 06.00.)	
49.33	6,080	W9XAA	Chicago, Ill. (U.S.A.). (Relays WCLEF.) (Sun. 19.00 to 20.30.)		25.6	11,720	CJRX	Winnipeg (Canada). (Daily 00.00 to 05.00, Sat. 21.00 to 06.00 also, Sun. 22.00 to 03.30 also.)	
49.33	6,080	CP5	La Paz (Bolivia). (Daily 00.45 to 02.15.)		25.57	11,730	PH1	Eindhoven (Holland). (Daily ex. Tues., Wed. 13.00 to 15.30 (Sun. Sat. to 16.30.)	
49.3	6,085	2RO	Rome (Italy). (Mon., Wed., Fri. 23.00 to 00.30.)		25.53	11,750	GSD	Empire Broadcasting	
49.26	6,090	VE9BJ	St. John (N.B.). (Daily 00.00 to 01.30)...		25.49	11,770	DJD	Zeesen (Germany). (Daily 17.00 to 21.30)	
49.26	6,090	VE9GW	Bowmanville, Ont. (Canada). (Mon., Tues., Wed. 20.00 to 05.00, Thurs., Fri., Sat. 12.00 to 05.00, Sun. 18.00 to 02.00.)		25.45	11,790	W1XAL	Boston, Mass. (U.S.A.). (Daily 23.00 to 00.30.)	
49.2	6,097	ZTJ	Johannesburg (S. Africa). (Daily ex. Sun. 04.30 to 05.30, 08.30 to 12.00, 14.00 to 20.00 (Sat. to 21.45), Sun. 13.00 to 15.15, 17.30 to 20.00.)		25.42	11,801	2RO	Rome (Italy). (Mon., Wed., Fri., 23.00) ...	
49.18	6,100	W3XAL	Bound Brook, N.Y. (U.S.A.). (Relays WJZ.) (Mon., Wed., Sat. 22.00 to 23.00, Sat. 05.00 to 06.00 also.)		25.36	11,830	W2XE	Wayne, N.J. (U.S.A.). (Relays WABC.) (Daily 20.00 to 22.00.)	
49.18	6,100	W9XAL	Chicago, Ill. (U.S.A.). (Daily ex. Mon., Wed., Sun. 21.00 to 07.00.)		25.36	11,828	CT1AA	Lisbon (Portugal) ...	
49.1	6,110	VUC	Calcutta (India). (Daily 07.06 to 08.06 irregular 13.06 to 16.36, Sat. from 12.36, Sun. 04.36 to 07.36, irregular 12.36 to 03.36.)		25.29	11,860	GSE	Empire Broadcasting	
49.1	6,110	GSL	Empire Broadcasting		25.27	11,870	W8XK	Pittsburg, Pa. (U.S.A.). (Relays KDKA.) (Daily 21.30 to 03.00.)	
49.08	6,112	YV2RC	Caracas (Venezuela). (Daily ex. Sun. 15.30 to 17.30, 21.00 to 03.00, Sun. 14.30 to 15.30.)		25.23	11,880	FYA	Paris, Radio Coloniale (France). (Colonial Stn. N-S.) (Daily 16.15 to 19.15, 20.00 to 23.00.)	
49.02	6,120	VQ7LO	Nairobi (Kenya Colony). (Daily 16.00 to 19.00, Sat. to 20.00, Mon., Wed., Fri. 10.45 to 11.15 also, Tues. 08.00 to 09.00 also, Thurs. 13.00 to 14.00 also, Sun. 17.45 to 19.00 also.)		25.0	12,000	RW59	Moscow (U.S.S.R.). (Relays No. 2 Stn.) (Sun. 03.00 to 04.00, 11.00 to 12.00, 15.00 to 16.00.)	
49.02	6,120	YDA	Bandoeng (Java). (Daily 10.30 to 15.00)		24.83	12,082	CT1CT	Lisbon (Portugal). (Sun. 14.00 to 16.00, Thurs. 20.00 to 21.00.)	
49.02	6,120	W2XE	Wayne, N.J. (U.S.A.). (Relays WABC.) (Daily 23.00 to 04.00.)		24.2	12,396	CT1GO	Paredo (Portugal). (Sun. 15.00 to 16.30, Tues., Thurs., Fri. 18.00 to 19.15.)	
48.92	6,132	ZGE	Kuala Lumpur (Malaya). (Sun., Tues. Fri. 11.40 to 13.40.)		23.39	12,830	CNR	Rabat (Morocco). (Sun. 12.30 to 14.00)...	
48.86	6,140	W8XK	Pittsburg, Pa. (U.S.A.). (Relays KDKA.) (Daily 21.30 to 06.00.)		22.94	13,075	VPD	Suva (Fiji). (Daily ex. Sun. 05.30 to 03.60.)	
48.78	6,150	CSL	Lisbon (Portugal). (Daily 11.00 to 12.30, 18.00 to 22.00.)		19.84	15,123	HVJ	Vatican City. (Daily 10.00, 15.30 to 15.45)	
48.78	6,150	YV3RC	Caracas (Venezuela). (Daily 20.30 to 01.30.)		19.82	15,140	GSF	Empire Broadcasting	
48.78	6,150	CJRO	Winnipeg (Canada). (Daily 00.00 to 05.00, Sat. 21.00 to 06.00 also, Sun. 22.00 to 03.30.)		19.74	15,200	DJB	Zeesen (Germany). (Daily 08.45 to 12.15)	
48.4	6,198	CT1GO	Paredo (Portugal). (Daily ex. Tues. 00.20 to 01.30, Sun. 16.30 to 18.00 also.)		19.72	15,210	W8XK	Pittsburg, Pa. (U.S.A.). (Relays KDKA.) (Daily 13.00 to 21.15.)	
47.50	6,316	HIZ	Santa Domingo (W. Indies). (Daily 21.40 to 22.40, Sun. 16.00 to 17.30 also.)		19.71	15,220	PCJ	Eindhoven (Holland). (Experimental) ...	
47.05	6,375	YV4RC	Caracas (Venezuela). (Daily 21.30 to 03.30.)		19.68	15,243	FYA	Paris, Radio Coloniale (France). (Colonial Stn. E-W.) (Daily 12.00 to 16.00.)	
46.69	6,425	W3XAL	Bound Brook, N.J. (U.S.A.). (Experimental)		19.67	15,250	W1XAL	Boston, Mass. (U.S.A.). (Daily 15.50 to 18.30.)	
46.52	6,417	HJ1ABB	Barranquilla (Colombia). (Daily 21.30 to 03.30.)		19.66	15,260	GSI	Empire Broadcasting	
46.21	6,490	HJ5ABD	Cali (Colombia). (Daily 00.00 to 03.00) ...		19.64	15,270	W2XE	Wayne, N.J. (U.S.A.). (Relays WABC.) (Daily 16.00 to 18.00.)	
46.0	6,520	YV6RV	Valencia (Venezuela). (Daily 17.00 to 18.00, 23.00 to 03.00.)		19.63	15,280	DJQ	Zeesen (Germany). (Daily 04.30 to 06.00.)	
45.31	6,620	PRADO	Riobamba (Ecuador). (Fri. 02.00 to 03.40.)		19.6	15,300	CP7	La Paz (Bolivia) ...	
45.0	6,667	HC2RL	Guayaquil (Ecuador). (Sun. 22.45 to 12.45, Wed. 02.15 to 04.15.)		19.56	15,330	W2XAD	Schenectady, N.Y. (U.S.A.). (Daily 19.30 to 20.30.)	
42.02	7,140	AJ4ABB	Manizales (Colombia)		19.52	15,370	HAS3	Budapest (Hungary). Sun. 13.00 to 14.00.)	
					17.33	17,310	W3XL	Bound Brook, N.J. (U.S.A.). (Daily 16.00 to 22.00.)	
					16.89	17,700	DJE	Zeesen (Germany). (Daily 13.00 to 16.30.)	
					16.88	17,770	PHI	Huizen (Holland). (Daily ex. Tues., Wed. 13.30 to 15.30, Sun. 15.30 to 16.10, Sat. 15.30 to 16.30 also.)	
					16.87	17,780	W3XAL	Bound Brook, N.J. (U.S.A.). (Relays WJZ.) (Daily except Sun. 14.00 to 15.00, Tues. Thurs., Fri. 20.00 to 21.00 also.)	
					16.86	17,790	GSQ	Empire Broadcasting	
					13.97	21,470	GSH	Empire Broadcasting	
					13.93	21,530	GSJ	Empire Broadcasting	
					13.92	21,540	W8XK	Pittsburg, Pa. (U.S.A.). (Daily 12.00 to 14.00.)	

The Wireless World

THE
PRACTICAL RADIO
JOURNAL
25th Year of Publication

No. 832.

FRIDAY, AUGUST 9TH, 1935.

VOL. XXXVII. No. 6.

Proprietors : ILIFFE & SONS LTD.

Editor :
HUGH S. POCOCK.

Editorial,
Advertising and Publishing Offices :
DORSET HOUSE, STAMFORD STREET,
LONDON, S.E.1.

Telephone: Hop 3333 (50 lines).
Telegrams: "Ethaworld, Sedist, London."

COVENTRY: Hertford Street.

Telegrams: "Autocar, Coventry." Telephone: 5210 Coventry.

BIRMINGHAM:

Guildhall Buildings, Navigation Street, 2.
Telegrams: "Autopress, Birmingham." Telephone: 2971 Midland (4 lines).

MANCHESTER: 260, Deansgate, 3.

Telegrams: "Iliffe, Manchester." Telephone: Blackfriars 4412 (4 lines).

GLASGOW: 26B, Renfield Street, C.2.

Telegrams: "Iliffe, Glasgow." Telephone: Central 4957.

PUBLISHED WEEKLY. ENTERED AS SECOND
CLASS MATTER AT NEW YORK, N.Y.

Subscription Rates :

Home, £1 1s. 8d. ; Canada, £1 1s. 8d. ; other
countries, £1 3s. 10d. per annum.

*As many of the circuits and apparatus described in these
pages are covered by patents, readers are advised, before
making use of them, to satisfy themselves that they would
not be infringing patents.*

CONTENTS

	Page
Editorial Comment	125
New Receiver Designs	126
The Signal at the Detector	133
Current Topics	135
At the Listener's End	136
Guide to the Stands at Olympia ..	138
Unbiased	140
The Loud Speaker	141
The Television Position	142
Listener's Guide for the Week ..	144
Hints and Tips	146
Notes on the 1936 Monodial AC Super	147
New Components	149
The All-Wave Set	153
Deaf-Aids	155
Modern Valves	159
Broadcast Brevities	160

EDITORIAL COMMENT

Olympia, 1935

Our Forecast of the Show

THE annual Radio Show opens at Olympia on Wednesday, August 14th, and is, as usual, the outstanding wireless event of the year.

We shall endeavour, as in previous years, to give our readers a full account of the Show in three Special Numbers. The present issue, which constitutes a Show Forecast, gives a general idea of what exhibits of special interest to look for, whilst by means of the key plan and list of exhibitors the visitor can locate any stand easily.

Our second Show Number, to be dated August 16th, will comprise a complete Stand-to-Stand Report, fully illustrated, and describing items shown by each exhibitor.

The third Show Number will constitute a more critical examination of the progress of the year, dealing in separate articles with things of outstanding interest from a technical point of view amongst every class of exhibit.

The present issue, whilst endeavouring to make reference to the outstanding exhibits which the visitor must not miss, cannot pretend to cover the ground exhaustively, for the reason that as it is compiled in advance of the Show, we are dependent upon early information collected or supplied to us. In some cases manufacturers prefer to disclose nothing concerning their products in advance in the hope that they may spring surprises at the last minute. It must not, therefore, be assumed, if certain manufacturers' products are not referred to yet, that nothing of interest will appear on their stands.

Early information in our possession leads us to the rather important conclusion that a halt has been made in the scramble for price reduction in sets

which has been going on during the past few years. The "popular" type of set suffered from this policy of the past, becoming less reliable than should have been the case, but inspection of some of this season's new models in this class gives the impression that much greater care has been exercised in manufacture, whilst prices have been maintained at about last year's level.

Price reduction, however, has taken place this season in the rather more expensive types of receiver. This can probably be taken as a healthy indication that the public is becoming more critical of quality and that the manufacturers are aware of it and are endeavouring to attract more attention to these superior models.

The former tendency to endeavour to make receivers as compact as possible has not been maintained, probably for the very good reason that servicing is seriously hampered by so doing.

Short-wave and All-wave Sets

Although short-wave sets and all-wave sets will not be on the stands of all set manufacturers, yet a very representative number will be found at this year's Olympia. Information concerning them will be found elsewhere in this and other Show issues.

Another feature of this Show will be the increase in the number of universal AC/DC receivers which have now almost entirely replaced receiver designs for DC mains alone.

Whilst the diversity of components for home construction is probably less than at previous exhibitions, it is satisfactory to find a considerable improvement in quality, as well as a good variety of up-to-date components. In this connection we would mention, in particular, intermediate frequency transformers designed to give variable selectivity.

NEW RECEIVER DESIGNS

Variable Selectivity—Tone-corrected Volume Control—Specialised Apparatus

ALTHOUGH the Olympia Show does not open until August 14th, it is already possible to form a useful opinion on the general trend of design of the new receivers. Many of the technical developments which have been discussed in these pages during the past year have now been embodied in commercially-built sets.

THIS preliminary survey of the activities of the British wireless trade for the 1935-1936 season is arranged, so far as complete receivers are concerned, under headings for the easiest possible reference by readers. Subtle changes in popular demand and in the steps taken both to anticipate and cater for it take place each year, and so the classification of our last Olympia Forecast has had to be revised.

It has now been found desirable to include all general-purpose AC mains receivers, from the simplest to the most ambitious, under a single heading. Next come universal AC/DC receivers of all types, followed by "all-wave" sets covering short, medium and long wavelengths, of which there are now enough to form a class—and by no means an inconsiderable one—of their own.

AC Mains Receivers

EVERY year recently has shown a greater tendency towards the use of the superheterodyne for every receiving purpose, and this year is no exception to the rule. More than ever before the superheterodyne is predominant, and the straight sets will be so few in number that they will nearly all fall into either the

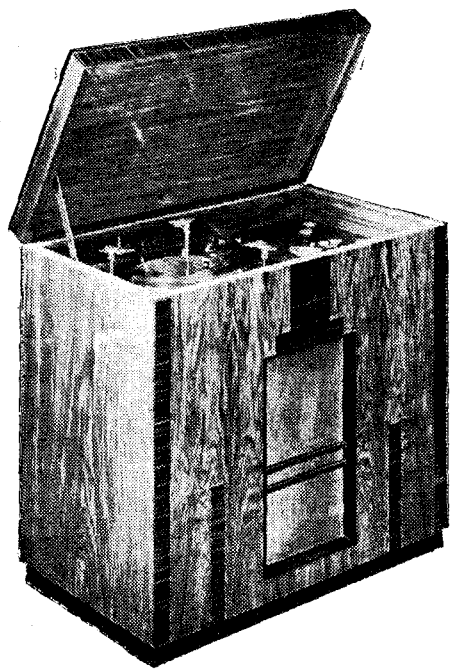

FIG. 1. R.G.D. Model 704 radio-gramophone.

Battery sets generally occupy another section, and lastly come the "special-purpose" receivers, designed to satisfy out-of-the-ordinary requirements or conditions, and among which some of the most interesting of the new productions are to be found. Amplifiers and public-address equipment are included here.

It should be understood that in many cases the basic receiver chassis to which our comments mainly refer (because, after all, it is the part that really matters) is often available in many forms: perhaps as a table model, an upright console set, or as a radio-gramophone.

Our classification by number of valves will not always agree with that of the manufacturer, as we prefer to omit the power rectifying valve from the total, thus facilitating comparison with sets having metal rectifiers.

cheapest class of set or the highly specialised type. Apart from these exceptions, which might almost be counted on the fingers of one hand, the superheterodyne reigns supreme, whether the receiver contains three valves or fifteen, whether it be an inexpensive general-purpose set or a luxurious high-fidelity radio-gramophone.

The popularity of this system of reception has been brought about by many factors. It started originally with the need for high selectivity, but the number of valves necessary for a satisfactory performance restricted it to the expensive class of receiver. It was then the turn of valve development and striking advances were made, for not only was the efficiency of valves improved, but multiple types were evolved; these developments were naturally reflected in a reduction in the number of valves necessary to a superheterodyne. For some years development on these lines has been proceeding and has now reached a point where a three-valve receiver gives a performance as good as that obtainable from a set with six or more valves a very few years ago.

In spite of these advances, the large superheterodyne is by no means abandoned, and, in fact, the number of valves used in the largest sets seems to be increasing; this, however, is due in some degree to the prevalence of AVC systems and muting devices, high quality LF amplifiers of large output, volume expansion, and the like. An inspection of the appara-

tus, which will be on view this year, shows that this class of receiver is larger than one might anticipate, and there are signs that the medium class of six to nine valves is falling in number.

Although not a new product, the H.M.V. High-Fidelity Autoradiogram cannot be briefly dismissed, for it is still

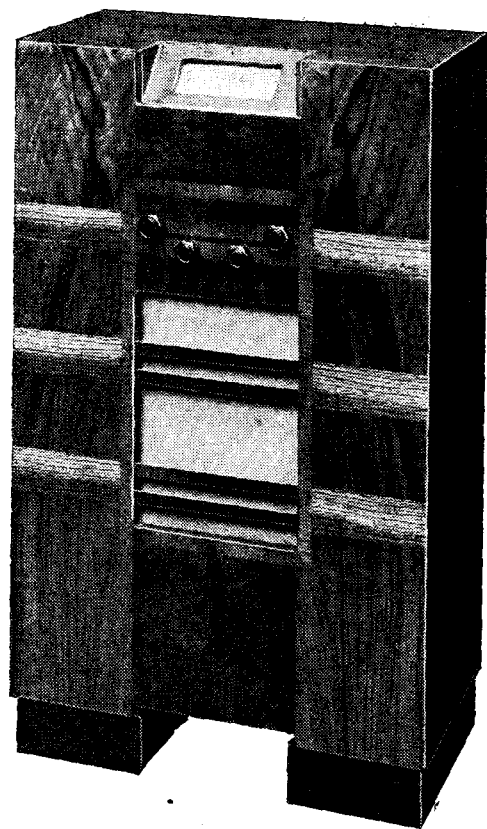

FIG. 2. The H.M.V. Console Superhet Five (Model 444).

outstanding in the number and variety of its technical refinements. Fifteen valves are used, and its specification includes variable selectivity, all-wave reception, QAVC, volume expansion, and an automatic record-changer.

Variable selectivity is obtained by altering the coupling in the band-pass filters in fixed steps by means of a switch. The IF amplifier is split into two channels in the last stage, one of which operates continuously for AVC purposes and the other of which is rendered inoperative when the set is not tuned to a signal in order to obtain the QAVC action. The volume expansion system can be thrown in or out of circuit at will by means of a switch.

New Receiver Designs—

The R.G.D. Model 1202 radio-gramophone also includes an automatic record-changer. Twelve valves are used, the LF equipment including a resistance-coupled paraphase amplifier having an output of 6 watts. Separate detector and oscillator valves are used in the frequency-changer,

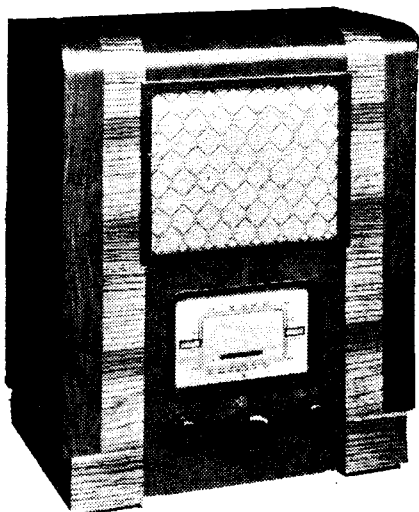

The Kolster-Brandes KB 428 includes the Fototune dial.

and both signal and intermediate frequency amplification is used. Amplified AVC is incorporated, and there is a muting system for inter-station noise suppression. Variable selectivity is fitted and the apparatus is listed at 107 guineas.

A two-valve frequency-changer is also used in a smaller receiver made by this firm, the Model 704. This has a signal-frequency amplifier and one IF stage with variable selectivity. A duo-diode-triode acts as a detector, LF amplifier, and AVC source, and is resistance coupled to a triode output valve. It is priced at 55 guineas.

The Dynatron receivers fall into the same class as regards price and the performance claimed, and they are particularly interesting as being the products of a firm which has consistently remained faithful to the straight set. The Model Er36 has six tuned circuits, using iron-core coils and embodying a triple band-pass filter; there are three HF stages. This set is priced at 120 guineas with elaborate LF equipment and cabinet work. Several other straight sets of various characteristics will be shown, and a short-wave converter designed to suit them will be available for those who want all-wave reception.

The Haynes Radio receivers also employ a straight circuit. Two HF stages are used with iron-core tuning coils and amplified AVC. Duophase LF amplification is fitted and outputs of 6 watts or 14 watts can be obtained. The prices range from £43 to £64. Table models are available without loud speaker at £25 to £36.

Turning now to receivers of the more "popular" class, the H.M.V. Model 444 includes QAVC and is priced at 17 guineas. A band-pass filter precedes the heptode frequency-changer; a single

IF valve is used and is followed by a duo-diode-triode which feeds the output pentode through a resistance coupling. The Model 441 has a similar circuit arrangement with amplified QAVC, and a tone-corrected volume control, while the Model 541 radio-gramophone, which has an output of 2 watts, is listed at 22 guineas.

The Kolster-Brandes Model KB428 is interesting as an example of the refinement which is now included in a set of quite modest price. It costs 14 guineas, but it is fitted with variable selectivity and a novel station-indicator known as the Fototune. A signal-frequency HF stage is used with a heptode frequency-changer, a single IF valve and a duo-diode for detection and AVC purposes. The output valve is a pentode and a neon tuning indicator is fitted. A smaller set of similar design but without some of the refinements is available at 12 guineas. This is the Model KB427, and an input band-pass filter to the heptode frequency-changer is used.

A receiver embodying dual loud speakers will be shown on the Burndept stand. This is the Model 201 Ethodyne at 15 guineas; an octode frequency-changer is employed with a single IF

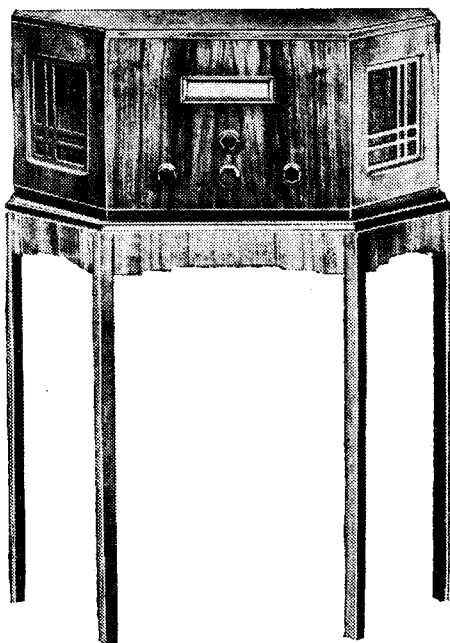

The Burndept 201 Ethodyne with dual loud speakers.

stage and a duo-diode acting as the detector and as the source of AVC voltage. The output valve is a pentode rated for an output of 3.5 watts.

The Bush Radio sets are featured by "Peaceful Tuning"—a system of QAVC which is fitted to many models. It is included in the SAG1, which is a portable set with built-in frame aerial, and also to the SAC7, a set intended for use with an outdoor aerial. This set has a band-pass input circuit with a special image suppressor; an octode frequency-changer is used with one IF stage and the duo-diode-triode which provides AVC is resistance coupled to a triode output valve delivering 3 watts to the loud speaker. The receiver is priced at 13½ guineas.

The City Accumulator Co. will be show-

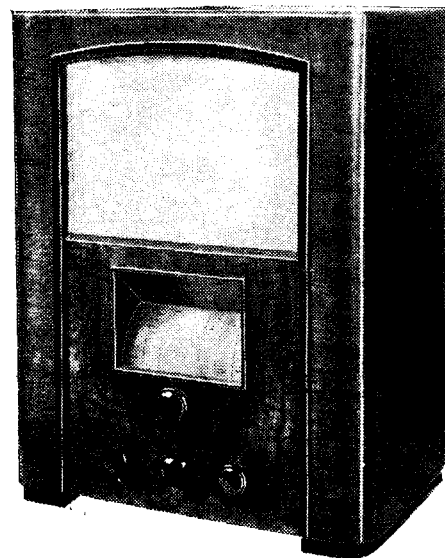

The Bush Radio SAC 25 Superheterodyne.

ing a wide range of receivers, and one of the most interesting will be the Austin AC Super-Six. This has dual speakers and a special tuning dial, known as the Scanning Disc dial, which gives twice the usual scale length for a given panel opening. A triode-pentode frequency-changer is used with one IF stage; the detector is a duo-diode-triode, followed by a pentode output valve. A separate valve is used for inter-station noise-suppression. A smaller receiver of less ambitious design, the Austin AC Super-Five, employs a heptode frequency-changer, and there will also be a three-valve straight set having a sensitivity of the order of 45 μ V. A single HF valve is used with three air-core tuned circuits and a triode grid detector. The pentode output valve feeds 3 watts to the speaker, and the set is listed at 9 guineas.

The Climax Sports-Model Band Pass TC III is also of the three-valve type with the conventional arrangement of the valves. The output is 3.4 watts. The Model QS5 of this firm is a superheterodyne of the four-valve type with an octode frequency-changer and a pentode output valve. QAVC is included, and the set is priced at 12 guineas.

Among the Ekco receivers the AC86 is of particular interest, in that it includes delayed amplified AVC together with automatic noise suppression. The frequency-changer is preceded by a band-pass filter specially arranged for second-channel interference rejection, and the single IF stage feeds a duo-diode. The output valve is a pentode. It is priced at 12½ guineas,

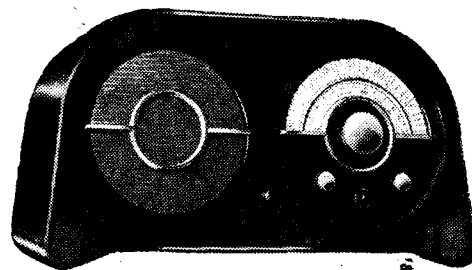

The Ekco AC86 is fitted with delayed amplified AVC and automatic noise suppression.

New Receiver Designs—

and is also available as a radio-gramophone at 22 guineas. The ACT96 has a similar circuit arrangement, but a signal-frequency amplifier is included, and the set is designed to work from built-in frame aerials. A tone-compensated volume control is fitted, and it is listed at 14½ guineas.

There is a general tendency to include a signal-frequency HF stage in the more expensive types of set, and one example of this trend will be found in the Decca Cabinet Radiogram, which is priced at 19 guineas. A heptode frequency-changer is used with one IF stage. AVC is fitted and obtained with the aid of a duo-diode-triode. In the Portrola set, however, priced at 12 guineas, the first valve is the frequency-changer — a triode-pentode —

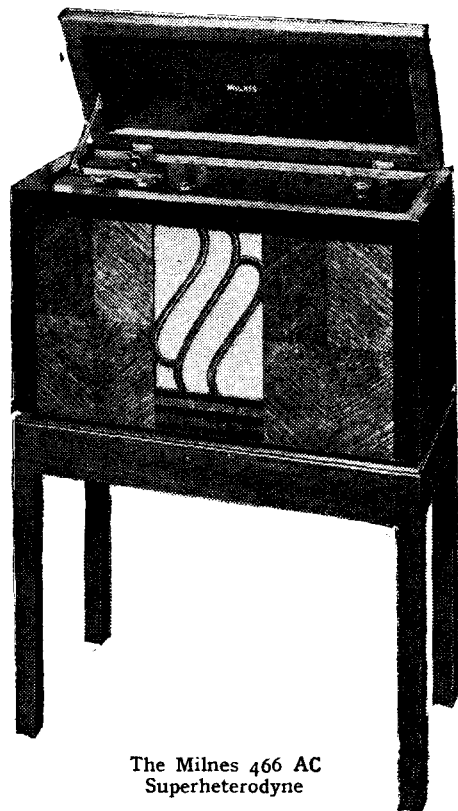

The Milnes 466 AC
Superheterodyne

and a combined duo-diode and output pentode is used.

The Cossor Model 364 is a three-valve superheterodyne with a heptode frequency-changer and band-pass input circuits. There is a single IF valve, and a duo-diode-output pentode provides detection and AVC. A neon tuning indicator is included. Ever-Ready will be showing a set with a similar arrangement of valves but using a triode-pentode frequency-changer. This is the Model 5002 at 12 guineas. The Model 5003 of the same firm at 14 guineas has an octode frequency-changer and an additional stage of LF amplification, while console and radio-gramophones will be shown.

In the G.E.C. range will be found the Fidelity AC5. This set employs an intermediate frequency of 125 kc/s, and the duo-diode-triode functions as a detector, an LF amplifier, and an AVC source. It is resistance-coupled to the pentode output valve which feeds a loud speaker fitted with a 10in. cone. As a table model the

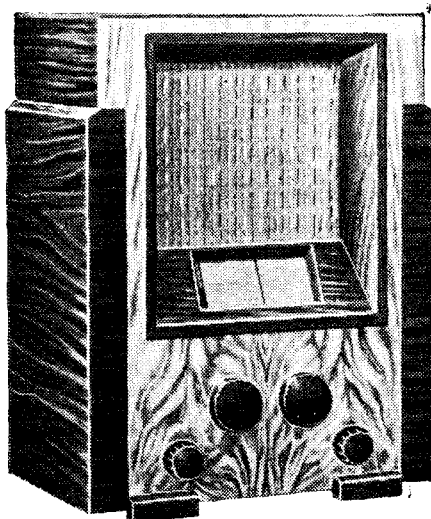

The Halcyon AC7 superheterodyne is fitted with a special AVC system.

set is listed at 13½ guineas, but it is also available as a radio-gramophone at 23 guineas, and with an automatic record-changer at 36 guineas. A three-valve superheterodyne, the AC4, will also be shown at 11 guineas.

A special AVC system is the feature of the Halcyon receivers, which are available in various styles ranging from a table model at 14 guineas to a radio-gramophone with record-changer at 35 guineas; while in the Milnes 466 receiver the IF stage is reflexed. The Ultra 25 is of the three-valve type with a duo-diode-output pentode, and this firm will also be showing a three-valve straight set of the HF-det.-pen. type.

Orr Radio will be showing the Invicta AC/45, for which a response up to 7,000 c/s is claimed. This set has variable selectivity in the single IF stage, and a duo-diode feeding an output pentode. QAVC is included, and the price is 11½ guineas.

One of the few examples of the straight set will be found on the Philips stand. This is the Model 577A with two HF stages and four efficient tuned circuits. Diode detection is used, and AVC is included. An output of 3 watts is obtainable from a pentode. A superheterodyne, the

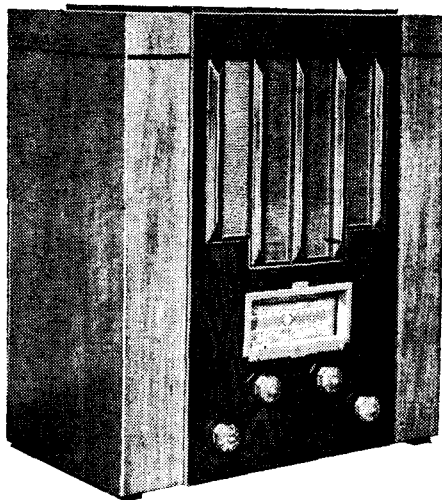

The Pye T9 receiver has a triode output valve fed from a duo-diode-triode.

Model 539A, will also be on view, and in this separate duo-diode and triode LF valves are used. QAVC is included. As a radio-gramophone this set is priced at 26 guineas. A small straight set with one HF stage will be shown. The specification includes a permanent magnet moving-coil speaker, and it is listed at 6½ guineas.

Among the Pye range will be found two receivers of similar general type but differing in their LF equipment. Both sets have a heptode frequency-changer, a single IF stage, and are equipped with QAVC. The T9 has a duo-diode-triode feeding a triode output valve, however, whereas the T7 has a duo-diode and a pen-

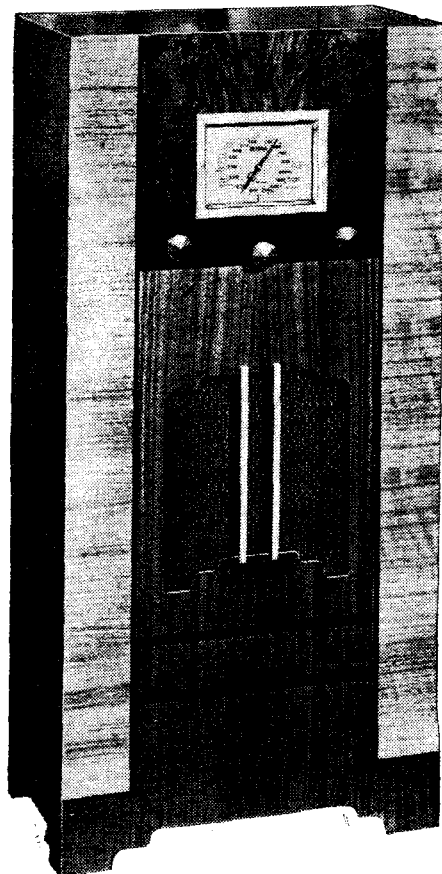

The Ultra 66 Console Superheterodyne.

tode output valve. The former is listed at 14 guineas, and the T7 at 12 guineas.

Ferranti will be showing the Arcadia superheterodynes, which are available in various models, including a radio-gramophone. The console is listed at 15 guineas, and a triode output valve is employed which has an output of 2.5 watts. AVC is fitted, of course, together with a noise suppressor. The tuning scale is calibrated in station names, and indicating pointers are fitted to all controls. The Lancastria receiver has a similar tuning scale, but the chassis differs considerably. The output valve is a duo-diode-pentode, and a heptode frequency-changer is employed. It is listed at 12½ guineas, and a model for AC/DC operation is available. The Nova receiver at 11 guineas has a similar electrical specification, but noise suppression and a visual tuning indicator are not fitted. A three-valve straight set of the HF-det.-pen. type, the Una con-

New Receiver Designs—

solette, is an addition to the range of this firm. A pentode output valve delivering 2.5 watts to the moving-coil loud speaker is used. It is priced at 8½ guineas.

Clarke's Atlas will have a six-valve superheterodyne with a push-pull output stage giving an output of 6 watts. Delayed amplified AVC is included, and the A22 console model is listed at 22 guineas; while a radio-gramophone, the A39, is priced at 39 guineas. A smaller set, the A24, has a single triode output valve and costs 24 guineas as a radio-gramophone.

The Aerodyne Silver Wing receiver has an octode frequency-changer and a single IF valve. A duo-diode is used for detection and AVC purposes, and the output valve is a pentode. It is priced at 11 guineas, and a universal AC/DC model is also available. A two-valve set, the Robin, with pentodes both for the detec-

tor and output valves is priced at 7 guineas.

The Ormond Model 607 is a straight three-valve set with iron-core tuning coils. A triode detector is used, and followed by a pentode output valve. It costs £9 15s.

Ace Radio will have a five-valve superheterodyne in which shadow tuning is employed. Naturally, AVC is fitted. It is priced at 10 guineas, and a radio-gramophone is available at 18 guineas. The Alba Standard superhets will be shown in a wide variety of cabinet styles at prices varying between 10½ guineas and 19 guineas. In every case a pentode valve provides an output of 3.4 watts.

The Blue Spot receiver has a special image suppressor for the reduction of second-channel interference. The output is 2.6 watts from a pentode, and provision is made in the design not only for the use of an external loud speaker but for the internal speaker to be cut out if desired.

Universal AC-DC Receivers

THOSE who go to Olympia this year to look for purely DC mains sets will be disappointed. With the exception of one or two specialised types they have entirely disappeared from the market. But there is no cause to regret their passing; the universal receiver now functions just as well on DC as the set designed solely for that form of supply. There is, of course, the added advantage that it will also work on AC nearly, but not quite, so well as if it was designed for nothing else.

Generally speaking, those who are seeking AC-DC sets have the choice of two types. First, there is the simpler form of HF-det.-LF three-valve (plus rectifier) receiver, which costs roughly between £7 and £9. The cheaper models generally have only two tuned circuits, but the more expensive ones include a band-pass aerial coupling, and consequently give greater selectivity. Secondly, there is the so-called small superheterodyne, usually with a total of four receiving valves, which costs from £10 upwards.

In addition to these two classes there

are one or two simpler det.-LF universal sets; an example of these is the Burgoyne "Fury" model, costing only 6 guineas. The same firm are to show a similar set with the addition of HF amplification at 7 guineas. The Ferranti Una model includes many of the features of the larger Ferranti receivers.

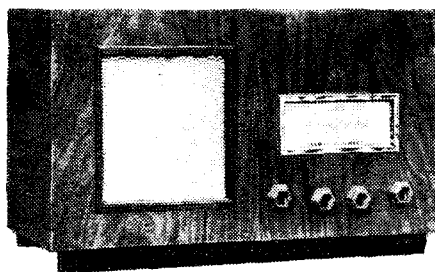

The Ferranti Una Console.

The Blue Spot "straight" set embodies a special filter for preventing "break-through" of signals from high-power stations and also includes double fuse protection, a feature to be especially commended in universal sets.

One of the few entirely self-contained universal sets is the Burndept Universal Mains Portable, a four-valve superheterodyne in an upright case of the "transportable" type.

A tendency to employ P-M speakers in universal sets and thus save the current that would otherwise be expended on energising the field magnet is exemplified in the Bush Radio DC/AC superhet, for which an output of 3½ watts is claimed.

Ekco are to show universal models of both superhet and "straight" types in the unconventional circular moulded cabinets that were introduced last year. The G.E.C. superhet embodies several useful features.

Ever-Ready, the well-known battery firm, has now introduced several receivers, one of which is a universal superheterodyne with seven tuned circuits and a P-M speaker. These sets are constructed

to allow for improved accessibility to the chassis—a reform that has more than once been pleaded for in this journal.

The H.M.V. universal four-valve superhet. works at a comparatively high intermediate frequency and embodies a special

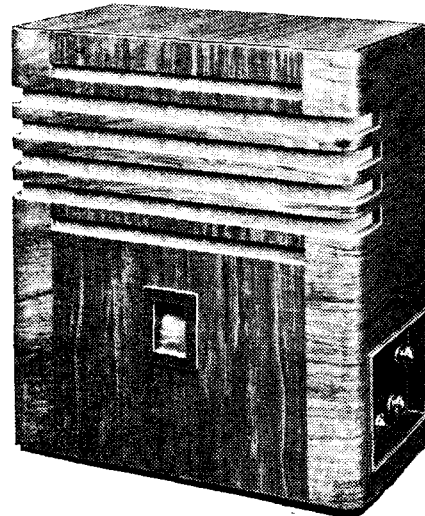

The R.I. Airflo receiver includes noise suppression.

rejector for morse and other forms of interference which might cause trouble. Both superheterodyne and "straight" models are to be shown by Halcyon, the former including a Westector; HT supplies are also derived through a metal rectifier. The same chassis is employed in the table model, radio-gramophone, and automatic radio-gramophone.

Another entirely self-contained universal set with built-in frame aerial is the Kolster-Brandes model KB425, which weighs only 29lbs. and so can be easily moved from room to room. The same firm have produced a superheterodyne with the feature



Kolster-Brandes AC/DC frame-aerial set.

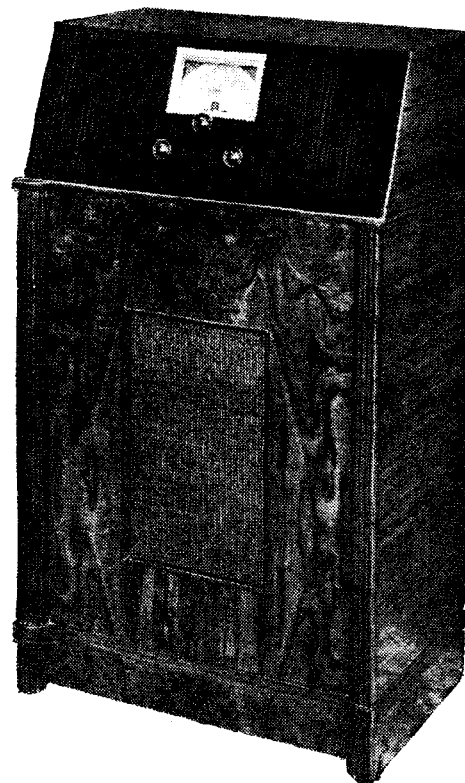

Alba universal console model.

New Receiver Designs—

of variable selectivity—an unexpected refinement at the low price of 12 guineas.

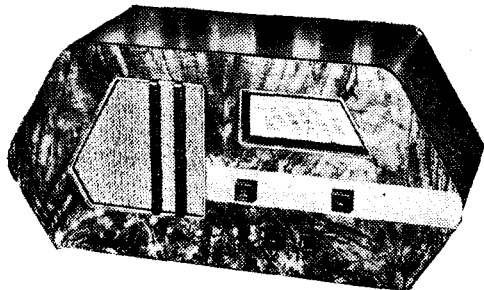

McMichael universal superhet.

McMichael now produce a universal superhet (Model 535), costing 12 guineas, which is similar, both externally and internally, to the AC model which was

recently reviewed so favourably in these pages. An improved form of constant aerial coupling is a feature of the set.

Interference from the high-power Droitwich station has apparently given food for thought to designers during the past year, and in many cases special means have been taken to avoid it, especially in the simpler type of set. For example, in the Philips "straight" AC-DC set with "superinductance" coils, a "Droitwich filter" is included. The corresponding universal superhet has an interchangeable station dial of new type.

Pye is also to show a superhet of the universal type—the first, we believe, that the firm has produced. Sets of which full details are not yet available are to be shown by several other firms, including Climax and Orr Radio.

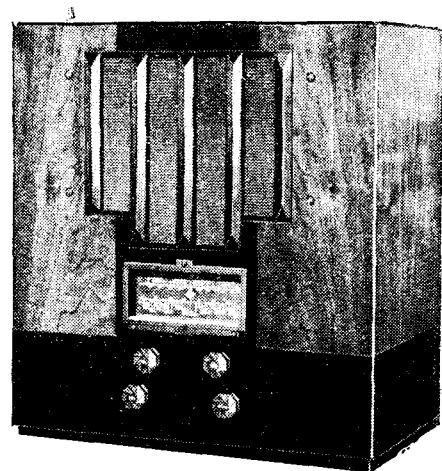

Pye battery superhet.

Battery Receivers

SO far as can be judged at present, the new battery sets may, with remarkably few exceptions, be divided into two classes—the HF-det.-LF three-valve group and the small superheterodynes. There are, of course, sub-divisions to this general classification; for example, the cheaper "straight" sets, costing from £6 upwards, have but two tuned circuits, while the slightly more costly ones include an extra circuit forming part of a band-pass filter. In this class pentode output is almost universal, although a few sets embody battery-economy circuits.

Among the superheterodynes, of which the average price seems to be between £10 and £12, there is rather more diversity of

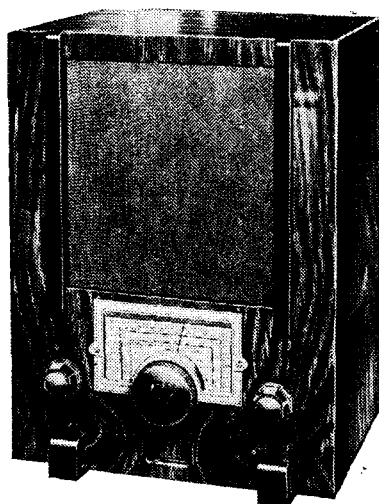

Blue Spot Battery Three.

possible to evolve a compact design and at the same time to use high-capacity batteries. An illuminated tuning scale is by way of being an extravagance in a battery set, and so a special form of dial with good light-collecting properties and a clearly visible on-off indicator has been devised. Class B output, with a special AVC circuit planned to minimise side-band screech when the set is slightly mistuned, is embodied in the C.A.C. 5-valve superhet.

Among the "straight" receivers it is

not unusual to find all valves are pentodes, as, for instance, in the Ace model, which embodies band-pass tuning and costs £6 19s. 6d. with batteries. The Ultra Model 77 is another example. Battery radio-gramophones are by no means uncommon this season; one of these is the Alba Model 430 at 14 guineas, with a straight circuit and pentode output. The same chassis is available as a table model.

Both diode valves and Westectors are used in the Bush superhets. The Climax "Sports Model," embodying a safety fuse, has a four-valve circuit including an octode frequency-changer. In the Ecko Model B86 a special noise suppressor device is fitted.

An unconventional solution to the battery problem is offered by Milnes sets, which derive their HT supply from a bank of nickel-cadmium accumulator cells

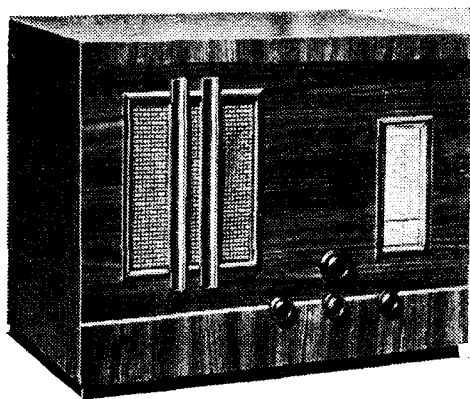

Orr Radio "Invicta" Model SHB.

circuit arrangement. As last year, honours are fairly evenly divided between Class "B" and QPP in the output stages of the more expensive sets, while the cheaper ones almost all use pentodes.

As examples of superhets with battery-economy circuits, the H.M.V. and C.A.C. productions may be cited. The first, known as Model 146, employs a double-pentode QPP output circuit and has the interesting feature of a pre-set reaction control by means of which sensitivity and selectivity may be regulated between wide limits. By adapting an HT battery divided into two sections it has been found

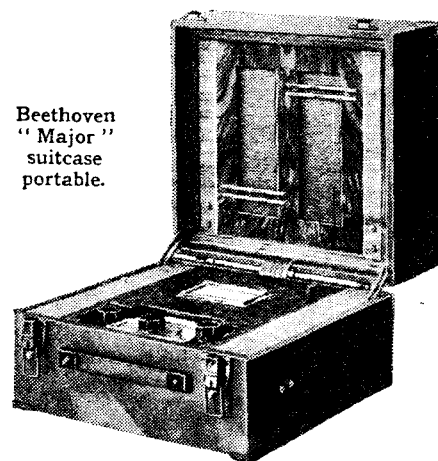

Beethoven "Major" suitcase portable.

which, by means of a switch, are connected in series for discharging and in parallel for recharging from the LT accumulator fitted in the set. Two "straight" models are to be shown, one with one HF stage and the other with two. The latter stage embodies double diode detection and AVC.

Although in most "straight" sets where band-pass tuning is employed the filter is to be found in the aerial circuit, in the Kolster-Brandes model KB429 it is situated between the HF amplifier and the detector. Iron-cored coils are to be found in a number of the "straight" sets at

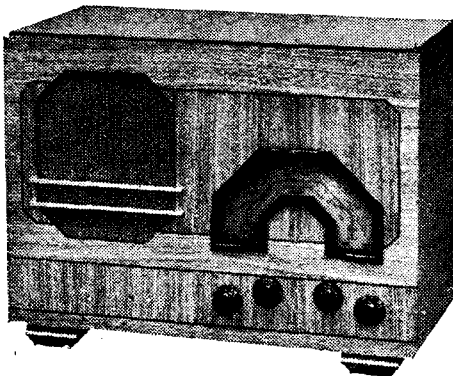

Aerodyne "Nightingale" model.

New Receiver Designs—

higher prices, and are even fitted in the Cossor model which costs only £6 15s. The corresponding Cossor superhet has a very up-to-date specification, and is priced at 9 guineas.

The design of portable battery sets seems to have settled down on fairly well-defined lines. Examples of the more strictly portable suit-case type are to be shown by Bur-

All-wave Receivers

ALTHOUGH the majority of sets on show will be designed for reception on the medium and long wavebands only, quite a large number of "all-wave" sets will be found. This term must not be mis-

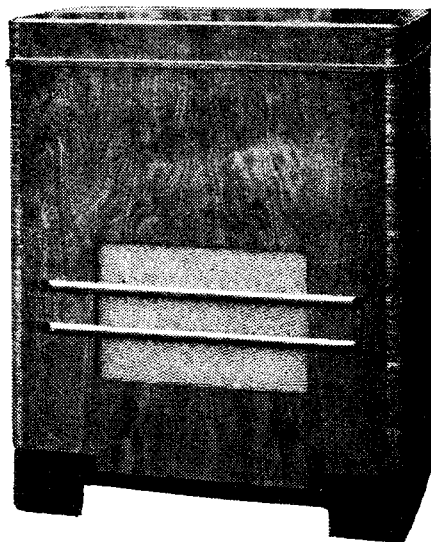

The Decca all-wave receiver is fitted with a dual-ratio tuning control.

interpreted, for it is safe to say that there is not a single receiver which tunes over all the wavelengths used for wireless communication. As generally applied to broadcast receivers, all-wave means that the set will tune over one or more short-wave ranges in addition to the medium and long wavebands. In some cases the additional ranges cover 13-200 metres, in others only 15-50 metres. The term "all-wave" is thus commonly employed with the meaning of a wider range than the usual.

One of the most interesting sets of this type will be the All-wave International Commander, for this has many unusual features. The tuning range is 12-560 metres without a gap and 800-2,000 metres. This wide range is accomplished in five bands, and there is a signal-frequency HF stage operative on all wavelengths. The receiver is a double-superheterodyne employing two frequency-changers; a single IF valve is used, and this amplifier includes variable selectivity. AVC is included as a matter of course, and the set is arranged for operation with a doublet aerial or with an aerial having a transposed feeder. The set is AC operated, and a special chassis construction is adopted which it is claimed enables a considerable reduction to be made in the

amount of screening incorporated; the set is priced at £30. This firm will also be showing a midget all-wave portable set measuring only 9in. by 7in. by 3in. It is priced at 6 guineas, and is of the two-valve super-regenerative type covering the short-wave broadcast, the trawler, and the medium wavebands. The Alba all-wave sets will be shown in both AC and Universal AC/DC types. Three wavebands are included, covering 19/52, 200/550, and 800/2,000 metres, and automatic volume control is fitted. The receiver is available as a table model at 16 guineas or as a radio-gramophone, Model 990, at 26 guineas. Climax will be showing their Model 534 receiver, which has two short-wave bands of 10/30 metres and 28/80 metres in addition to the usual medium and long wavebands. A band-pass aerial circuit is used with an octode frequency-changer and a single IF stage. A duo-diode-triode provides detection, delayed amplified AVC, and LF amplification, while the output valve is a pentode delivering 3.4 watts to the loud speaker. A tone control is included, and the dial has a ratio of 150-1 for easy tuning on short waves. The set is priced at 16 guineas.

In the Decca set an HF stage is used, and the frequency-changer is a triode-hexode, and is followed by two IF stages. The tuning control has two ratios, one for accurate tuning and another for rapid searching. The waveranges are 18/45, 200/550, and 1,000/2,000 metres, and the set is listed at 24 guineas.

The Ever-Ready Model 504 is an interesting departure from the usual practice, for it includes a signal-frequency HF stage which is used on the short waves only. On the medium and long wavebands a band-pass filter precedes the frequency-changer. There is a single IF stage feeding a duo-diode-triode which provides AVC and operates the output pentode.

The Dynatron all-wave receivers consist of straight broadcast sets to which are

added short-wave converters of special design, so that the equipment becomes a short-wave superheterodyne. Three tuned circuits are employed in the converter in order to reduce second-channel interference to a minimum, always a difficult problem on short waves. It may be mentioned at this point that most Kolster-Brandes receivers are suitable for short-wave reception with the addition of a converter, for which special provision is made in the design of the receiver.

The Philips range of receivers includes an all-wave set, the Model 575A, which tunes over the bands of 16/50, 200/570, and 750/2,000 metres. An HF stage precedes the octode frequency-changer, QAVC is fitted, together with a tone-compensated volume control. The apparatus is available as a radio-gramophone at the price of 26 guineas.

The R.G.D. all-wave equipment embodies no fewer than thirteen valves, of which a large number are used in the paraphase LF amplifier. In addition to the medium and long wavebands, short-wave ranges of 15/30 and 30/60 metres are provided. The intermediate frequency is 465 kc/s, and this amplifier includes variable selectivity.

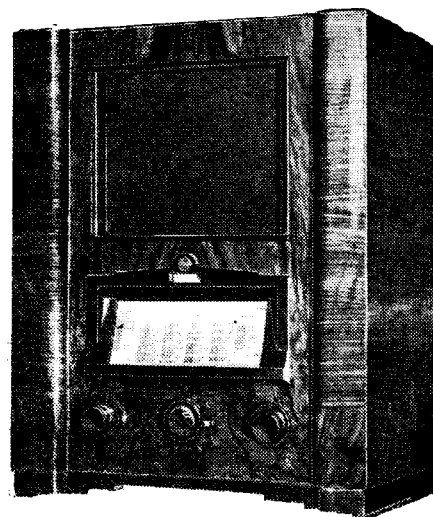

The Philips receiver has a signal-frequency HF stage and covers 16/50 metres as well as the medium and long wavebands.

The Burndept Model 230 is designed for AC/DC operation, and is unusual in being a straight set. An HF stage is used, and both the detector and output valves are pentodes. The tuning range is 17.5/2,000 metres, and the set is priced at 10 guineas. An all-wave set, the Ether-Cruiser 7, having three ranges, will be among the Mavox series shown by National Radio Service.

Special Purpose Apparatus

IT is no longer justifiable to reproach the British broadcast industry with failing to meet the demand for abnormal receivers—a demand which undoubtedly exists, and which cannot be satisfied by stereotyped domestic sets. Special conditions and circumstances are constantly arising where facilities for reception are desired,

but even if there is not yet a specialised set for every conceivable job there is at least a wider diversity of choice than ever before, and with a little ingenuity it is almost always possible to find something that can be adapted for the purpose in view.

There is also the question of special

New Receiver Designs—

requirements, rather than special purposes. A number of listeners, realising that the standardised set must, in the nature of things, be a compromise, have rightly decided that more satisfying results

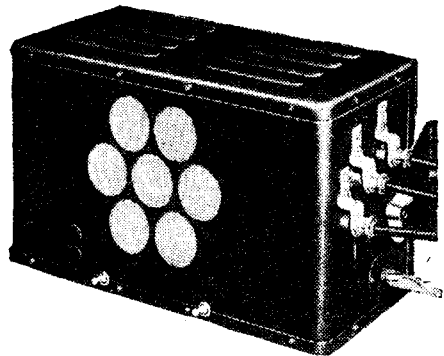

The new G.E.C. car radio set.

are likely to be obtained if they decide to forego those qualities in a receiver which do not appeal to them and concentrate on the kind of performance that they really want.

Perhaps the most important section of the "rebels" who think along these lines are those who want exceptional quality of reproduction, particularly in the direction of extended high-note response, and to get it are willing to sacrifice long-distance reception to a greater or lesser extent. Up to a point their needs are met by some of the receivers discussed under the general classifications, but there are several specialist firms who cater almost exclusively for this type of listener. Hartley-Turner, for example, make only medium-range sets with no great pretensions as to sensitivity but with the highest possible audio-frequency coverage. A typical production is the M12, with two low-gain HF stages and a special LF amplifier, in which correction is introduced for high-note loss occurring in the tuned circuits. Tone may be controlled by the user by "tilting" the response curve bodily. Several similar Hartley-Turner sets are



R.I. schools receiver with gramophone equipment.

available for the present season, some of them in the form of kits of parts.

A more determined effort than hitherto is being made this year to provide truly portable sets which, if not exactly of pocket size, are no more difficult to carry than a camera. The Allwave International midget model measures only 9in. by 7in. by 3in., and embodies a super-regenerative circuit covering short and medium waves as well as the trawler and yacht telephony bands. Another set of even smaller dimensions is announced by Empiric, but details are not yet available for publication.

It appears certain that at least three car radio receivers will be shown, and others may appear at the last moment. The C.A.C. model, with which readers are already familiar, is of the single-unit type with remote control. In essentials the new G.E.C. set is similar, but arrangements are made to use an extension loud

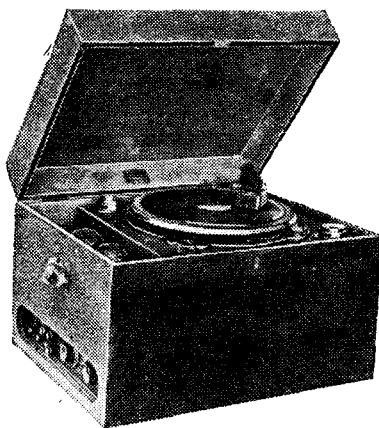

Ossicaide gramophone amplifier.

speaker. The third set is less conventional; described as a "Home and Car" receiver, it is a Decca production, and is arranged so that it will operate either from AC mains or from a car battery. Necessary circuit changes are effected simply by plugging in to the chosen source of power; when fed from an accumulator, HT voltage is derived from a rotary converter. Two distinct models of this set are to be shown.

Schools receivers, approved by the Central Council for School Broadcasting, are specialised R.I. productions. Several models are available; a "straight" or superhet circuit, with or without gramophone equipment, may be chosen. In every case the loud speaker is separate from the set, and it would not be surprising if these outfits were to find many applications other than that for which they were primarily designed.

Amplifying equipment of much greater versatility than hitherto is to be shown by several firms. The Tannoy universal amplifier can be operated either from AC, DC or from a 6-volt or 12-volt car battery. Another portable amplifier, designed essentially for operation in a car, is to be shown by Ossicaide.

An amplifier with the exceptional power output of 30 watts is to be a feature of the Sound Sales exhibit; this instrument

uses a "low loading" output circuit and gives an almost flat response from 50 to 10,000 c/s. The *Wireless World* Quality Amplifier is made in commercial form by this firm.

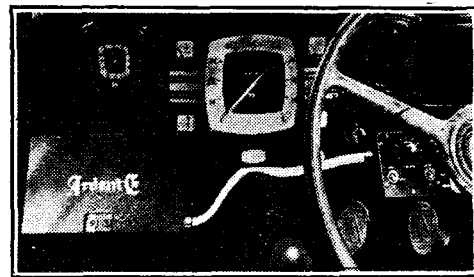

Ardente mobile amplifier and control unit installed in a car.

A typical Ardente amplifier is the Model SA 318, with a gain of 84 db. and uniform response from 80 to 8,000 c/s. It is adaptable to many purposes. Another Ardente model is the Radio-Micro-Gramophone, with special provision for the connection of microphones and faders, etc. There is also an all-purpose mobile amplifier working from a 6-volt car battery, with controls specially arranged for installation in the vehicle. Film Industries are to show a number of amplifiers, both fixed and mobile, including a portable 6-watt universal AC-DC set.

In addition to the all-wave receivers described elsewhere, specialised short-wave sets will be exhibited by several firms, including a battery-operated set by Allwave International.



Sound Sales 30-watt amplifier.

Stratton and Company (Eddystone) announce an entirely new model, the Quadradync, with a "straight" circuit; the set is housed in a welded steel cabinet, and, unlike most others of its type, includes a built-in speaker. An Eddystone superheterodyne for operation on the 5-metre band is also announced, as well as an experimental transmitter for ultra-short waves.

The Signal at the Detector

High-voltage and Low-voltage Rectification Compared

By M. S. GRAHAM

*N*EARLY all the popular small superheterodynes may be divided into two groups; in the first, the detector is called upon to handle small voltages only, while in the second it must deal with large inputs. The influence of this "low-level" or "high-level" detection on design and performances is discussed.

MANAGING directors and other non-technical persons who command radio sets to be designed generally fail to understand one very important thing about the designer's job—that hardly any part of a set can be touched without vitally affecting almost every other part. They think that a valve can be added like an extra potato to make up the bushel. And the proposal that a slight change in the type of one of the valves necessitates a complete redesign of the whole receiver seems preposterous. But anybody who has practical experience of designing realises that this is quite a possible situation and not merely much ado about nothing.

The "greatest common factor" on the radio market just now is the superhet with about four valves, exclusive of rectifier. It has been with us for several seasons as a fairly standard sort of product. But a technical division can be made of it into two groups on a rather interesting basis—what may be called high- and low-level detection. It may seem a trivial point, the voltage which the detector is designed to handle; but starting off from it the whole design is influenced.

Pre- or Post-detection Amplification?

Let us look into the thing more closely. If current designs are examined from this point of view it will be found that most of them fall clearly into two classes; those in which (for full volume) the IF amplifier has to supply the detector with a fairly large signal—something of the order of 10 volts—which therefore necessitates a detector of the diode type, giving a result that can be passed straight on to a high-sensitivity output pentode; and those in which the detector has to cope with only one or two volts at the most (and may therefore be of the leaky-grid type), which makes an LF amplifier in front of the output valve an essential.

For the purpose of reckoning valves a leaky-grid detector being as it is a diode detector followed by a LF amplifier may be considered as equivalent to a diode-triode, or double-diode-triode, which again is equivalent to separate diodes or metal

rectifiers followed by a triode amplifier.

Assuming one stage of IF amplification, the simplest type of low-level detection superhet has four valves—frequency-changer, IF amplifier, detector-cum-LF amplifier, and output valve. A high-level set, having no LF stage, may either be content with three valves, or use up the extra one as a pre-selector or HF stage. Of course, the low-level set may have this stage, making five; but supposing that in each case the designer has four valves to play with, it follows that the high-level set has a HF stage and the low-level has none. Typical sets of each class, therefore, possess valves functioning as in Fig. 1.

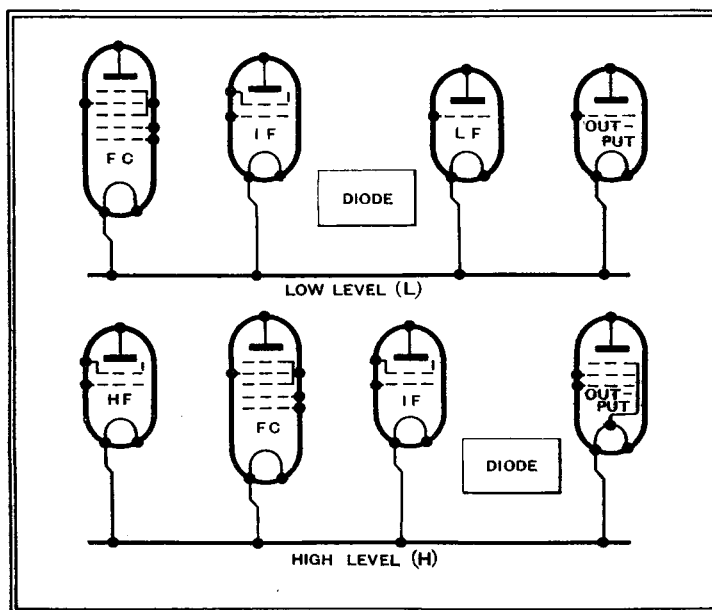

Fig. 1.—Typical functions of valves in small superhets with low-level and high-level detection; the diode detector is usually combined with one of the amplifying valves.

Which is the more desirable scheme? There are plenty of each on the market, so that settles nothing. Let us consider the qualities that a receiver should possess and compare the two types on each count.

First, sensitivity. We are not concerned with which would win in this respect if a valuable cash prize were offered, but which is likely to have the higher sensitivity in ordinary everyday practice. The

two balance out fairly evenly, but on the whole the honours may be placed with the high-level set ("H") at medium and long wavelengths, particularly as its output valve generally amplifies more than that in the low-level set ("L"). But at short wavelengths the HF stage generally does so little that "L" definitely wins. And if one wants to have a really sensitive set it can be got more satisfactorily by adding a HF valve to "L" than by trying to work in another HF or IF valve to "H."

So far as sensitivity is concerned then, much depends on whether or not short waves are in view.

High-level Gains

Selectivity. Here again the decision can hardly be given outright, as it depends so much on circumstances. It can be assumed that they have the same number

of tuned circuits, for the circuit between the first two valves of "H" is tacked on to the front of "L" to form a band-pass system. And in any case, the selectivity depends chiefly on the IF circuits. But there is slightly more chance of the high-level set enjoying greater freedom from second-channel and IF interference.

The question of distortion need not arise in very acute form, but it is obvious that "H" works the detector under better conditions. When the level at the detector is only perhaps a fraction of a volt it is impossible to avoid

the curved foot portion of any detector characteristic. The LF stage peculiar to "L" gives scope for further distortion; but on the other side of the balance sheet it must be admitted that, unless the IF stage in "H" is properly designed to handle the large signal amplitude, it, too, may introduce distortion.

When we consider the matter of noisiness the verdict is clearer. Supposing, for example, that the signal at the detec-

The Signal at the Detector—

tor of "L" is one-tenth that of "H," hum (or any other noise) introduced at that point is relatively ten times as great. Alternatively, for the same freedom from hum the smoothing must be ten times as effective. That has a bearing on cost. The "L" type also runs whatever risk there may be of LF microphony. And the signal level at the frequency-changer being relatively low, oscillator valve noise is proportionately more prominent. To set off against this there is less possibility of instability at the forward end of the receiver.

Complicated Gramophone Switching

The larger LF magnification, which is a drawback where hum is concerned, keeps one out of difficulties when provision has to be arranged for a gramophone pick-up. Then one has to start looking around for some auxiliary decibels in the "H" model, involving the complication of switching to convert the IF or FC valve into a temporary LF amplifier. It can be done, but it is the sort of thing one would like to do without.

AVC, once a luxury, is now universal in sets of the types under our consideration. The high-level detection scheme might have been made for AVC (it probably was). To start with, there are three valves to control instead of two (unless one moves up into the five-valve class), so control is decidedly more effective.

The rectified voltage to be fed back for controlling these valves should reach about 20 or 30 with strong signals. Where is it to come from? In an "L" set the amplitude required at the detector to give full volume may be no more than a fraction of a volt. But call it 1 volt (peak) for the sake of round figures. When very weak stations are being received, of course, the amplitude is less than this. Until it reaches this level the rectified voltage is prevented by applying a counteracting delay voltage from reducing the amplification of the valves. But at the level where full volume is obtainable the delay voltage has been fully neutralised, and any further increase brings the AVC into action. Over the range of signal strength at which the AVC is operating, and at which the volume is supposed to be kept nearly constant by it, the voltage at the detector (assuming it to be the same as that used for developing the AVC voltage) varies from 1 to at least 20. And as power depends on the square of voltage, this means a variation in volume—supposing the output stage to be capable of handling it—of 1 to 400 or more!

AVC on these lines is merely a courtesy title. The way out of this difficulty is amplified AVC. But it is a thorny way.

Turn now to the high-level detector set. The type of output pentode commonly used therein needs about 4 volts peak for full volume. Allowing for some loss this means about 4.8 from the detector. It is generally agreed that full output should be obtainable when the carrier wave is being modulated 30 per cent. On this

assumption the input to the detector must be $\frac{4.8 \times 100}{30}$ —or 16, giving probably 15 volts output from the AVC diode. This, then, is the figure chosen for the delay voltage. The strongest signal should push it up to, say, 45 volts at the most, to give a balance of 30 for controlling the valves. The increase over the controlled range of signal strength is thus in the ratio of 1 to 3 only, in spite of providing a larger number of controlling volts than in the preceding example.

The contrast between the two is emphasised by the diagram in Fig. 2. The vertical scale indicates the output that would be got from the last valve, with the volume control at maximum, if it were capable of handling the volume without distortion. Of course, the curves can be moved bodily downwards by adjusting the volume control.

A detail to consider is that the point at which a valve begins to "detect" is uncertain within limits of a fairly large fraction of a volt. If the desired delay voltage is not so very much greater than this,

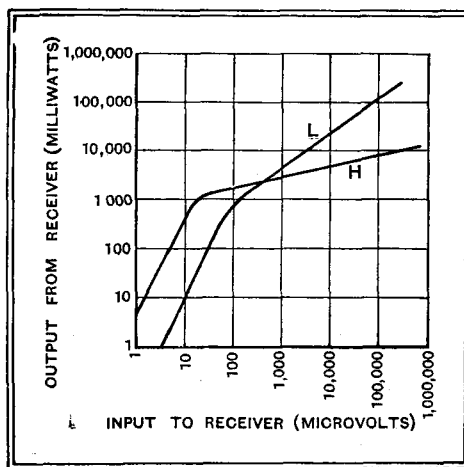

Fig. 2.—Outputs of low-level and high-level detector sets compared.

the exact level at which AVC begins to work depends quite considerably on the particular valve in use. Moreover, the AVC voltage comes into action much more gradually, instead of with a pronounced "knee," as in the high-level model.

The Muting Control

A further refinement is quiet AVC—"Q" for short. There are innumerable ways of accomplishing it, but the principle of the most important group is a delay voltage applied to the signal diode, so that nothing can be heard unless the signal strength exceeds a certain level. There is thus either complete silence or a programme of sufficient strength above stray noises to be worth having. This arrangement as described is too simple to be good; for, when a station does break through the delay voltage, a substantial part of it is still suppressed, causing intolerable distortion. Some means are required of suddenly cancelling the delay voltage the moment it has been exceeded and of restoring it when the signal falls below it. All sorts of clever ways have been devised for doing this; but it is understandable

that a method may be quite successful in cancelling a delay of not more than about a volt, and be quite inadequate if it is necessary to deal with 20 volts. That is a point to the score of type "L."

Lastly, there is the question of IF harmonic interference. It is beyond the scope of the present article to discuss this subject—it is simple enough in principle: the action of the detector inevitably produces harmonics of the intermediate frequency; and, except in "Single-Span" receivers, some of these come within the bands of medium and long broadcast frequencies, and are therefore liable to cause interference if there is even a small amount of leakage from the region of the detector to the aerial end of the receiver.

Harmonic Feed-back

The easiest way of seeing what bearing, if any, the detector signal level has on this problem is to assume some conveniently round numbers that are somewhere in the right respective neighbourhoods. For "H" let us take 10 volts as the amplitude of IF at the detector and 10 microvolts as the signal at the aerial required to produce it. Suppose a particular interfering harmonic is present in the proportion of 10 per cent., that is, 1 volt. And that one-millionth strays back to the aerial; one microvolt. That is, 10 per cent. of the input signal, and if it differs from it by an audible frequency there will be a loud whistle.

The following table shows the comparative figures for the two types of receiver:—

	"H."	"L."
Input signal; microvolts ..	10	10
IF signal at detector; volts ..	10	1
IF harmonic at detector; volts	1	0.1
IF harmonic straying back to input; microvolts ..	1	0.1
Interfering signal as percentage of input signal ..	10%	1%

This is assuming that the sensitivity of "L" is as great as that of "H." Actually, it is likely to be somewhat less; 25 microvolts, perhaps, which would make the percentage of interference smaller still, 0.4 per cent.

This comparison is confirmed in practice by experience; which is that, whereas IF harmonic interference is usually unnoticeable in the low-level type of set without any very special precautions, it is quite a major problem in the "H"—that is if the designer bothers his head about odd whistles here and there.

Summarising: the high-level detection type of set is unquestionably the better adapted for plain delayed AVC, but the advantage is somewhat offset when QAVC is required. It is definitely inferior as regards IF harmonic interference. It is also at a disadvantage as a gramophone amplifier because of the extra switching and components required. But it is decidedly easier to keep free from hum and other forms of intrusive noise. There is very little, if any, margin in respect of the three cardinal virtues of sensitivity, selectivity and fidelity; but what margin there may be is probably on the credit side.

And now . . . consider your verdict!

CURRENT TOPICS

Events of the Week in Brief Review

Radiolympia

INTERPRETERS speaking nearly all European languages will occupy a kiosk in the centre of the Grand Hall. The Information Department of the Radio Manufacturers' Association will also be available there to answer enquiries.

The "Post Office Village" will hold even more wireless interest than in previous years.

P.O. engineers' work in eliminating interference with radio reception will be illustrated by actual operation of certain types of electrical plant and machinery as well as by a special film in the free cinema.

Disturbance caused by medico-electrical apparatus will be graphically illustrated, as will measures adopted by the Post Office for its prevention.

P.O. cables as used in broadcasting circuits all over the country will be shown.

The world's biggest radio station—the famous Post Office transmitter at Rugby—will be featured.

Scale models of the B.B.C. transmitter at Droitwich will be shown in the special B.B.C. exhibit. The exterior model is built to a scale of 1 in. to 35 ft. and the interior $\frac{1}{4}$ in. to 1 ft.

Over the interior model is a key which explains the apparatus.

Microphones dating from 1923 to the present day will be shown on the B.B.C. stand.

Wireless World readers will be specially interested in an exhibit of outside broadcast gear as installed at the more prominent "O.B." points, such as Queen's Hall and St. George's Hall. The apparatus is mounted in racks. Visitors will see the mixing panel and the switching and meter devices.

A striking mural photograph will give the spectator an impression of the day-to-day activities of the B.B.C. with glimpses of studio performances, outside broadcasts, running commentaries and concerts.

"Ultra Shorts" at Luton

FIVE-METRE tests are being conducted in the Luton district by Mr. J. C. Lee (G6JL), Manor Villa, Limbury, Luton. Readers interested in ultra-short-wave work are asked to co-operate.

Music and Radio Merger

THREE of the oldest British music trade associations have just combined forces. They were originally known as the Gramophone and Radio Dealers' Association, the Music Merchants' Association, and the Music Trades' Association. These three bodies have been

Wireless on Cars

MR. HORE-BELISHA, Minister of Transport, has declined to give a definite assurance that his Department will not introduce any form of control or limitation of car radio.

Blackpool's Relay Problem

THE fact that the large number of overhead wires has given rise to serious complaint has prompted the Blackpool Corporation to suggest a merger between the four local radio relay exchange firms. If they fail to come to terms it is possible that they will lose their operating rights, their agreements with the Corporation having terminated last year.

For Road Users

EVERYTHING that could help a motor cyclist to a clearer understanding of his

Canine Address System

A UNIQUE "public address" installation has been fitted at the greyhound kennels at Northaw, Herts. Each of the 900 kennels contains a loud speaker operating either as a microphone or as a reproducer. When a dog creates a disturbance he unwittingly lights a warning lamp in the central control room to which all the loud speakers are wired, and a keeper can at once address him individually with a few well chosen words.

Electrical Interference

THE daily and weekly Press has strongly supported *The Wireless World* in urging that representatives of the Post Office should resign from the I.E.E. Committee which has been considering the problem of electrical interference with broadcasting reception for the last two and a half years, and so enable the Postmaster-General to introduce a simple Bill making unreasonable interference illegal.

"Tuner," writing in the *Yorkshire Observer*, says: "Years ago there was a general agitation over the elimination of electrical interference, and the reply of the tramway authorities was in effect: 'We were in existence before radio; why should we take the burden and be called upon to meet the costs.' This was a fatuous argument . . . The tramway people will say: 'We are not the only offenders.' I know it, and for this reason I want to join forces with *The Wireless World* in its campaign to secure legislation making such interference illegal.

"Although I pay 10s. a year I am not allowed to cause interference with other people's reception, yet without paying any licence fee I can buy an electric motor, switch it on and interfere with the reception of people in a wide area. That is unfair, grossly unfair.

"But, says the manufacturer, why should he bear the cost? I may be a nudist. I am not, but presume for a moment I am. I have a decided objection to wearing clothes at any time or in any place. I could come to the office nude and feel quite comfortable. But public opinion would be offended. I must be clothed, but who pays for my clothing? I don't want it; it is for other people's sake I must dress, then why should I pay? I have to pay because common decency demands that I should be dressed."

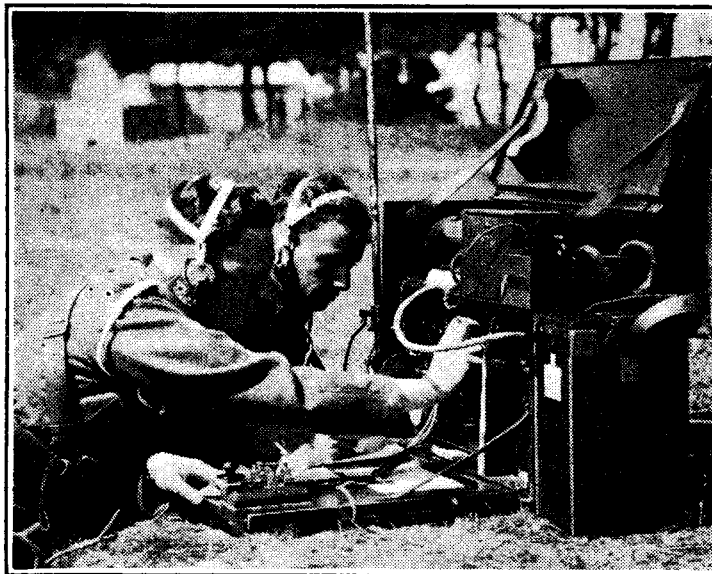

FIELD DAYS: THE REAL THING. Territorial signallers photographed near Aldershot last week with a Service radio transmitter.

formally wound up and replaced by a new society known as the Music and Radio Distributors' Association.

Wireless Telephony in Iceland

THE radio telephone service between England and Iceland which was opened on August 1st is carried out in Iceland with equipment supplied from England by the Marconi Company.

The Icelandic station is situated near Reykjavik, and in addition to communication with England provision is made for wireless telephone communication between the principal centres in Iceland itself.

machine can be found between the covers of "Hints and Tips for Motor Cyclists," the twelfth edition of which has just been issued by our publishers, Iliffe and Sons Ltd. Each hint is numbered, facilitating quick reference. The price is 2s. net, by post 2s. 3d.

The motoring novice is well provided for with "Your Car: How It Works." This is an extremely simple explanation of the fundamentals of all motor cars, and probably contains many facts unknown even to experienced drivers. "Your Car: How It Works" is obtainable from any bookseller, price 1s. net, or post free from Iliffe and Sons Ltd., 1s. 2d.

At the Listener's End

How He Can Combat Electrical Interference

By H. F. SMITH

A SIMPLE summary of the methods of interference suppression open to the average amateur. It is urged that a worth-while reduction in background noises, which is so important to users of sensitive high-quality sets, can be effected in the great majority of cases at little trouble or expense.

IN a well-ordered world, governed by pure reason and equity, there would be little need for this article. Interfering radiation from electrical appliances would be regarded as a nuisance in the legal sense, just as any other anti-social activity, and it would be compulsory to suppress it at its source.

For the sufferer from interference to apply the remedies to be suggested is admittedly wasteful and inefficient; a single piece of electrical apparatus may cause trouble to dozens of wireless users, each of which would probably have to spend at least as much time and money in curing or mitigating the trouble as would the owner of the appliance in entirely preventing its occurrence.

But at the present time there is in this country no legal ban on the production and dissemination of interference, and where remedial measures have been applied at the source, such action is purely voluntary or has been dictated by fear of adverse public opinion. In some quarters legislation is anticipated, but the law proverbially moves slowly, and, as urged in a recent Editorial in this journal, the I.E.E. Committee, on whose findings legislation (if any) will probably be based, is not noticeably more rapid.

In view of the probability of protracted delay, it is rather surprising that the average listener does not himself do more to reduce interference. In most cases a real improvement can be effected, and the cost per head is low, even though the total expenditure of a number of listeners affected from the same source may mount up to a large sum. Interference suppression is so simple that no

handyman with even a nodding acquaintance with electrical and radio matters need hesitate to undertake it.

Almost all the man-made interference that reaches our sets is due to sudden interruptions or changes in electrical circuits; switches, commutators, and indeed make-and-break devices of all kinds are responsible. Such devices act as flatly tuned transmitters, sending out trains of waves covering so vast a band of frequencies that it is impossible to discriminate against them by tuning. But

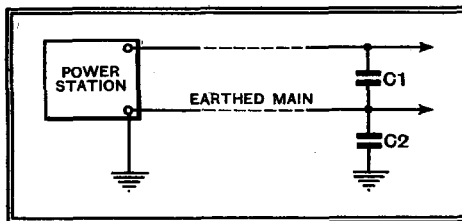

Fig. 2.—Explaining how the filter of Fig. 1 (b) avoids leakage to earth of AC.

very little serious interference comes directly from the offending appliance; most of it is passed into the mains and through them is disseminated far and wide.

Proof of Mains Radiation

The classical experiment to prove this is to run a defective fan motor alternately from an accumulator battery and from the mains; in the first case, a receiver in the next room may hardly be affected, but in the second all the neighbouring wireless users connected to the same mains supply will probably suffer. In all such cases the interference is either radiated from the mains on to the aerial, or else conducted directly into the set via its connection to the mains.

Failing suppression at the source, the cure for these troubles is clearly to insert a barrier of some kind in the mains so as to prevent the conduction of impulses to the set or their radiation; alternatively,

the same effect will be achieved if the aerial can be removed from the field of radiation.

The listener who decides to make an effort to improve the background to his reception will be well advised to make a

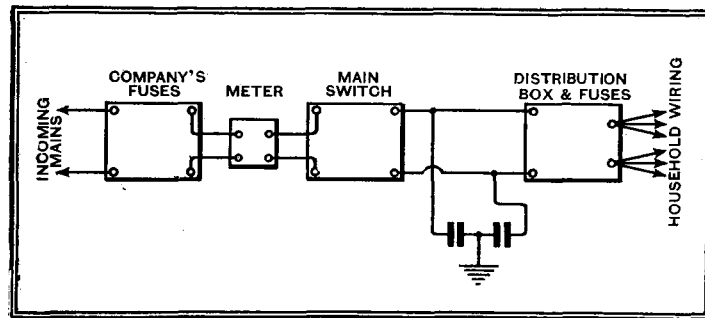

Fig. 3.—Diagrammatic sketch showing a convenient position for a mains input filter.

start with the simple and cheaper cures, and it is suggested that in average circumstances the following course of procedure will be best. Never carry out anti-interference experiments when atmospherics are present, as they are easily confused with "man-made static." The best time to work is in daylight, and not in thundery weather.

The Most Useful Suppressor

The most generally used type of suppressor is the simple condenser filter shown in Fig. 1 (a), the purpose of which is to by-pass interfering potentials on either mains lead to earth before they have a chance of doing damage. As a safety measure against the possibility of breakdowns in the condensers, fuses are generally inserted in the positions marked by crosses. Condensers of 2 mfd. each are customarily employed, but such large values are frowned upon for connection to AC mains, and a lower value—say, 0.01 mfd.—is now advocated.

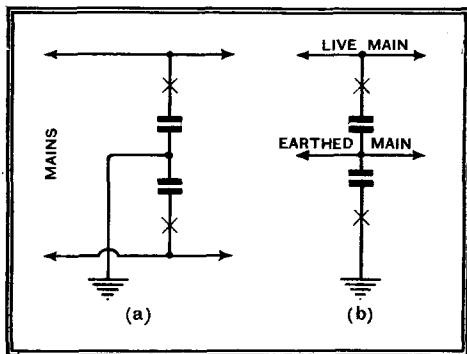

Fig. 1.—Two basic anti-interference filters; (a) is most suitable for DC and (b) for AC.

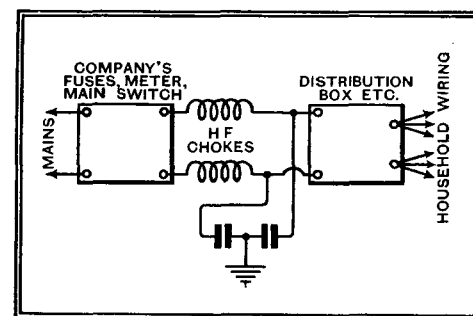

Fig. 4.—A choke-condenser filter; it is sometimes advantageous to transfer the condenser to the other side of the chokes.

At the Listener's End—

Alternatively, large condensers can be employed on AC mains by adopting the form of connection shown in Fig. 1 (b); this proves to be equally effective and avoids the earth leakage to which power-station engineers object so strongly. As shown in Fig. 2, the voltage across C2 is

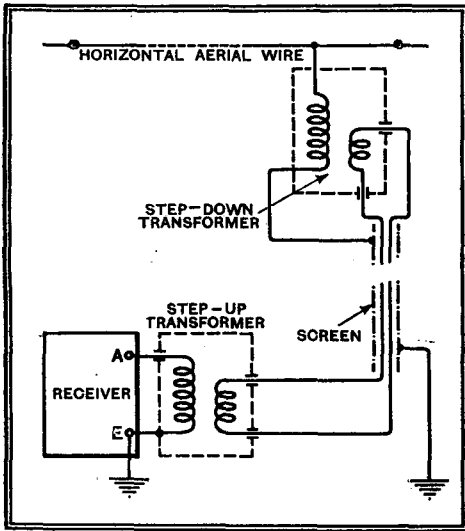

Fig. 5.—The theory of the transmission line download.

only that "dropped" along the earthed main; true, C1 is still across the source, but the current passing through it is nearly wattless, and the wastage of energy is negligible.

Condenser filters may be connected either across the mains at the point where they enter the listener's house, or across the feed leads which supply the set with current. The first is likely to be much more effective than the second, for the reason that, if things go according to plan, it will prevent interference from reaching the house wiring, whence it would normally be radiated on to the aerial. The receiver-lead filter, on the other hand, is only really effective in curing conducted interference, but it may help a little in reducing radiation from the feed wires on to the aerial download and the wiring and unscreened circuits of the set. As it is so easy to apply, it will be discussed first.

The Best Position

Either of the arrangements shown in Fig. 1 are applicable to a receiver-lead filter, depending on whether the supply is DC or AC. The best position for the filter is not on the receiver itself, but at the power point; in this way, radiation from the flex lead is avoided. A separate earth for the filter is always desirable, and wherever a choice of "earths" exists, each should be tried. Incidentally, this applies to every kind of suppression device; the connecting leads should also be

as short as possible and the condensers should be of the highest grade, non-inductive, and with a generous voltage rating.

The mains input filter shown in Fig. 3 is the most valuable of all devices available to the average amateur. Its effects are often amazing, and if care is taken it is as easy and safe to fit. Usually it is convenient to connect it either to the main switch, fuse-box, or distribution-box; in any case, as close as possible to the point of entry, bearing in mind that the meter and company's fuses must not be tampered with.

Where plain condenser filters prove inadequate they may be supplemented by HF chokes, making a still more effective barrier. Unfortunately, these chokes when connected in the most effective position—at the mains input—have to carry the entire domestic current with negligible voltage loss, and so their resistance must be low.

Where none of these devices proves entirely effective, the next step is to fit a screened aerial download. The theory of this valuable aid to suppression is simple; the field of radiated interference is strictly limited, and the aim is to elevate the

loss can be obviated by fitting an unscreened download at the remote end of the aerial and connecting it to the set via a transmission line in the manner shown in Fig. 6.

Some Suggestions

This covers in outline the practical methods of interference suppression available in ordinary cases. It should be emphasised, however, that each case must be treated on its own merits. For instance, where separate meters for both power and lighting are installed, it is usually necessary to filter both, but a test can be carried out by opening the main switch of the supply circuit which is not connected to the set; if matters are not improved by doing so, it is unlikely that a filter will do any useful work.

Again, those living in flats and attached houses should realise that interference may emanate from wiring not under their control, and so the neighbours should be called upon to do their part.

As to whether separate components or ready-assembled units are used for setting up the various suppressors discussed, is a

matter of choice; the first course is perhaps slightly more economical, but less risk of failure through using unsuitable parts is run by obtaining devices specially designed for their job. In addition, the suppressor units are neater, and, moreover, several of the firms selling them offer a service of technical assistance that is well worth having in cases of difficulty.

If suppressor devices are assembled from components, one should never yield to the temptation to use old condensers from the junk box. A few years ago all paper-dielectric condensers were highly inductive, and in many cases were practically useless for bypassing HF currents. Incidentally, this explains why, in spite of the fact that the theory of interference suppression was fairly well understood as long

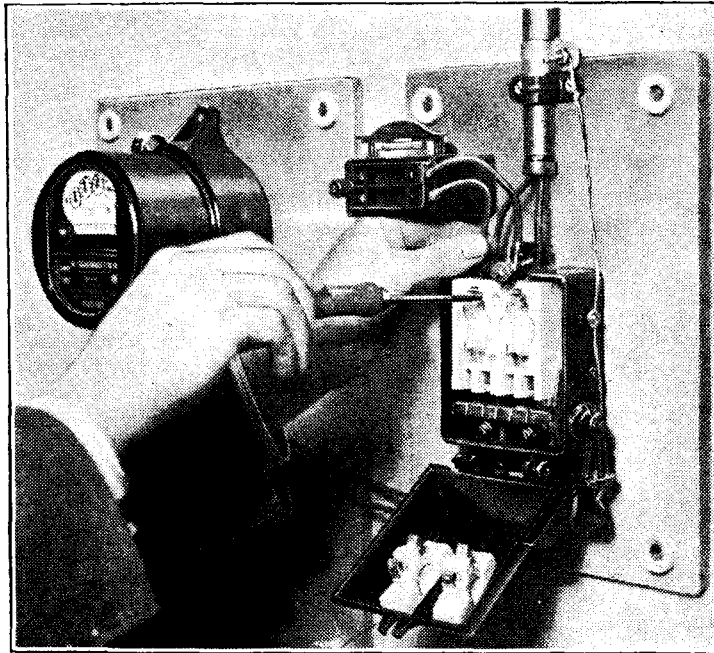

Reproduced from "Interference Suppression" by courtesy of Belling & Lee, Ltd.

Fitting a condenser suppressor to the main fuse-box.

"business" or signal-collecting part of the aerial above it, screening that part of the download which of necessity passes through the field on its way to the set. Where a short download can be employed, it suffices to use a simple length of the special low-loss screened cable sold by firms specialising in these matters, but for long runs it is better to avoid losses by turning the download into a matched "transmission line" by using at each end one of the special transformers available for the purpose. Generally speaking, a screened aerial should be higher than an ordinary one, as its signal-collecting properties are impaired by screening the download; in some cases, however, this

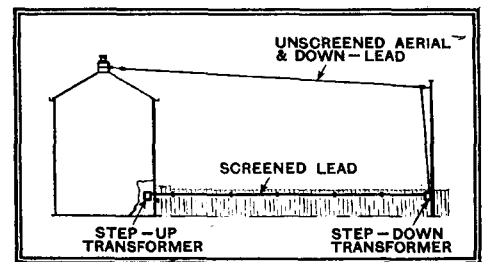

Fig. 6.—A screened lead-in with unscreened download.

ago as 1925, attempts then made to apply it in practice were so often unsuccessful.

A suppressor should, of course, have no prejudicial effect on reception except in cases where a mains aerial is in use, or where the aerial is so inefficient that much of the signal pick-up is due to the mains.

The Wireless World STAND FINDER

GUIDE TO ALL EXHIBITORS AT OLYMPIA

Any Stand in the Exhibition can instantly be located by using this squared plan in conjunction with the references shown in black type in the accompanying list of exhibitors

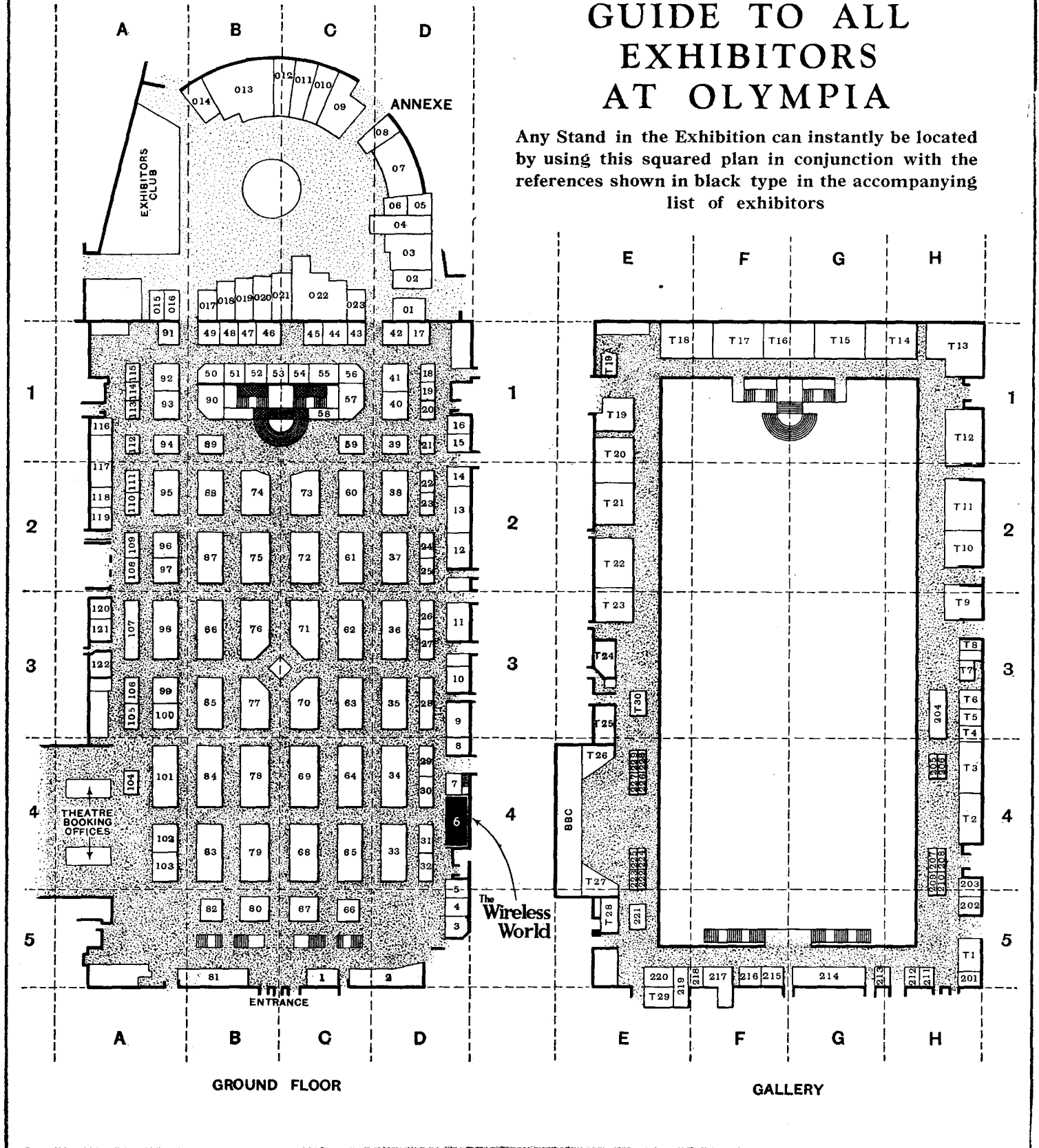

A selection of Constructional Receivers recently described in the pages of this journal will be on view at "The Wireless World" Stand (No. 6).

Exhibitors at Olympia

Alphabetical List, with Stand Numbers and References to Plan Opposite

Name.	Stand.	Name.	Stand.	Name.	Stand.
ACE Radio	97	A 2	EAST LONDON Rubber Co., Ltd.	T18	E 1
Adey Portable Radio	1	C 5	Eastick, J. J., & Sons (Ealex)	T9	H 3
Aerialite, Ltd.	8	D 4	Edison Swan Electric Co., Ltd. (Ediswan)	79	B 4
Aerodyne Radio, Ltd.	72	C 2	Electrico (Croydon), Ltd.	114	A 1
All Power Transformers, Ltd.	211	H 5	Electro Dynamic Construction Co., Ltd.	112	A 1
Allwave International Radio & Television, Ltd.	109	A 2	Ensign, Ltd.	T13	H 1
Anson & Hopwood, Ltd.	87	B 2	Empiric, Ltd.	41	D 1
Automatic Coil Winder & Electrical Equipment Co. Ltd.	103	A 4	Epoch Reproducers, Ltd.	47	B 1
BALCOMBE , A. J., Ltd.	65	C 4	Erie Resistor, Ltd.	15	D 1
Beethoven Radio, Ltd.	60	C 2	Ever Ready Co. (G.B.), Ltd.	71	C 3
Belling & Lee, Ltd.	91	A 1	Everett Edgcombe, Ltd.	229	E 4
Benjamin Electric, Ltd.	42	D 1	FERRANTI, LTD.	74	B 2
Bird, Sydney S. & Sons, Ltd. (Cylton Radio)	118	A 2	Film Industries, Ltd.	4	D 5
Britannia Batteries, Ltd.	40	D 1	Flinders (Wholesale), Ltd.	T6	H 3
British Blue Spot Co., Ltd.	28	D 3	Fuller Accumulator Co. (1926), Ltd.	119	A 2
British N. S. F. Co., Ltd.	48	B 1	The "Wireless World" STAND No. 6.		
British Permel Enamelled Wire, Ltd.	50	B 1	GARRARD Eng. & Mfg. Co., Ltd.	57	C 1
British Pix Co.	201	H 5	General Electric Co., Ltd. (G.E.C.) .. 35	D 3 , 44	C 1 , & 63
British Rola Co.	43	C 1	Gilbert, C., & Co., Ltd.	T23	E 3
British Television Supplies, Ltd.	14	D 2	Goodmans (Clerkenwell), Ltd.	51	B 1
British "Wireless for the Blind" Fund	52	B 1	Graham Farish, Ltd.	64	C 4
"Broadcaster, The"	T26	E 4	Gramophone Co., Ltd. (H.M.V.) .. 77	B 3 , &	82
Brown Bros., Ltd.	T12	H 1	Grampian Reproducers, Ltd.	111	A 2
Brown Radio Co., Wm. F.	210	H 4	HACKER , H. & Sons (Dynatron)	32	D 4
Browning Wireless Manufacturers	228	E 4	Halcyon Radio, Ltd.	36	D 3
Bulgin, A. F., & Co., Ltd.	117	A 2	Hartley-Turner Radio, Ltd.	23	D 2
Burgoyne Wireless (1930), Ltd.	2	D 5	Haynes Radio	10	D 3
Burndept, Ltd.	61	C 2	Heayberd, F. C., & Co.	25	D 2
Burton, C. F. & H.	105	A 3	Hellesens, Ltd.	21	D 1
Bush Radio, Ltd.	85	B 3	Hendersons Wholesale Elec. & Radio Ltd.	T28	E 5
CADISCH & Sons	T20	E 1	Henleys Telegraph Works, Ltd.	53	B 1
Celestion, Ltd.	26	D 3	High Vacuum Valve Co., Ltd. (Hivac)	27	D 3
Central Equipment, Ltd.	3	D 5	Hillman Brothers	T8	H 3
Chloride Electrical Storage Co., Ltd.	59	C 1	Hobday Bros., Ltd.	T22	E 2
Churchmans, Ltd.	T30	E 3	ILIFFE & Sons, Ltd.	6	D 4
City Accumulator Co., Ltd. (C.A.C.)	38	D 2	Itonia, Ltd.	T14	H 1
Clarke, H., & Co. (M/c), Ltd. (Atlas)	83	B 4	JACKSON Bros. (London), Ltd.	110	A 2
Climax Radio Electric, Ltd.	22	D 2	Johnson Talking Machine Co.	T11	H 2
Cole, E. K., Ltd. (Ekco)	76	B 3	KINGSWAY Radio, Ltd.	17	D 1
Colvern, Ltd.	55	C 1	Kolster-Brandes, Ltd. (K.B.)	78	B 4
Concordia Electric Wire Co.	218	F 5	LAMPEX Radio & Electric Co.	24	D 2
Cosmocord, Ltd.	221	E 5	Lectro Linx Ltd. (Clix)	115	A 1
Cossor, A. C., Ltd.	70	C 3	Lissen, Ltd.	86	B 3
Crypto Equipment Co.	215	F 5	Lugton & Co., Ltd.	T10	H 2
DALLAS , J. E. & Sons, Ltd.	T3	H 4	L.E.S. Distributors	T25	E 3
Darwins, Ltd.	107	A 3	McMICHAEL Radio, Ltd.	68	C 4
Davies Woodwork, D. M.	45	C 1	Manufacturers Accessories Co. (1925) Ltd.	T7	H 3
Dayzite, Ltd.	T5	H 3	Marconiphone Co., Ltd. .. 11	D 3 & 69	C 4
Decca Gramophone Co.	34	D 4	Milnes Radio Co., Ltd.	204	H 3
De la Rue & Co., Ltd.	5	D 4	Mullard Radio Valve Co., Ltd.	75	B 2
Dent, R. H. (Ardente)	46	B 1	NATIONAL Radio Service Co.	12	D 2
Dew, A. J., & Co., Ltd.	T21	E 2	New London Electron Works, Ltd.	39	D 1
Dibben, Horace, Ltd.	T1	H 5	OLDHAM & Son., Ltd.	66	C 5
Diggle, A., & Co., Ltd.	16	D 1	Ormond Engineering Co., Ltd.	33	D 4
Dubilier Condenser Co. (1925) Ltd.	67	C 5	Orr Radio, Ltd.	96	A 2
Dulcetto-Polyphon, Ltd.	T16	F 1	Ossicaide, Ltd.	T21	A 3
Dyson, J., & Co., Ltd.	T17	F 1	PARTRIDGE , Wilson & Co., Ltd.	104	A 4
			Peto & Radford	94	A 1
			Philips Lamps, Ltd.	62	C 3
			"Pianomaker, The"	T29	E 5
			Plessey Co., Ltd.	20	D 1
			Portadyne Radio	80	B 5
			Primus Manufacturing Co., Ltd.	19	D 1
			Prism Manufacturing Co.	116	A 1
			Pye Radio, Ltd.	84	B 4
			RADIO Gramophone Development Co., Ltd. (R.G.D.)	88	B 2 & 89
			Radio Instruments, Ltd. (R.I.)	102	A 4
			Radio Society of Great Britain	202	H 5
			R.A.P., Ltd.	106	A 3
			Rawplug Co., Ltd.	120	A 3
			Regentone Products, Ltd.	93	A 1
			Reproducers & Amplifiers, Ltd. (R. and A.)	56	C 1
			Rists Wires & Cables, Ltd.	213	G 5
			SELECTA Gramophones, Ltd.	T24	E 3
			Siemens Electric Lamps & Supplies, Ltd.	100	A 3
			Sonochorde Reproducers, Ltd.	54	C 1
			Sound Sales, Ltd.	108	A 2
			Stratton & Co., Ltd. (Eddy-stone)	30	D 4
			Suffex, Ltd.	205	H 4
			Sun Electrical Co., Ltd.	T15	G 1
			Swift, Levick & Sons, Ltd.	113	A 1
			TANNOY Products	90	B 1
			Telegraph Condenser Co., Ltd. (T.C.C.)	37	D 2
			Telephone Mfg. Co., Ltd. (T.M.C.)	29	D 4
			Thompson, Diamond, & Butcher	T19	E 1
			Tucker Eyelet Co. Ltd.	122	A 3
			The 362 Radio Valve Co., Ltd.	212	H 5
			ULTRA Electric, Ltd.	73	C 2
			Union Radio Co.	18	D 1
			VANDERVELL , C. A. Ltd., Varley	214	G 5
			Vidor, Ltd.	98	D 4
			WATERHOUSE , Frederick, Ltd.	219	E 5
			Webber, J. M., & Co., Ltd.	T2	H 4
			Westinghouse Brake & Signal Co., Ltd.	101	A 4
			Weston Electrical Instrument Co., Ltd.	216	F 5
			Wharfedale Wireless Works	203	H 4
			Whiteley Electrical Radio Co.	95	A 2
			Wingrove & Rogers, Ltd.	49	B 1
			"Wireless & Gramophone Trader, The"	T27	E 4
			Wireless Retailers Association	T4	H 3
			"Wireless World, The"	6	D 4
			Wright & Weaire, Ltd.	217	F 5

UNBIASED

No Bed of Roses

I HAVE from time to time had some hard things to say about the nattily attired tailors' dummies whose duty in life it is to be off-hand, supercilious, and generally unhelpful to those members of the public who happen to wander into their establishments with a vague idea of buying a wireless set.

I have, however, been duly humbled by the receipt of several abusive letters informing me that there is another side to the story, and that in reality these individuals are patient, long-suffering and philanthropic souls, whose one sorrow in life is that they cannot afford to give their goods and services to the public for nothing. Their life is, apparently, no bed of roses, as a book of this title, which has recently been published about the matter, informs me. One of the chief lessons which has to be learned by any youth aspiring to join this profession is, so I am informed, to suffer fools gladly.

By FREE GRID

I am very pleased to say that I can personally vouch for the necessity of the latter qualification owing to a personal experience which befell me the other day. Had I not experienced it myself I would never have believed that any member of the great radio public could be so ignorant and temper-trying, and I gladly offer my sympathies and my apologies to any salesmen for any wrong that I may have done them in the past.

I happened to be at my local dealers buying a new DO75 valve for use in the output stage of a set belonging to an aunt of mine who is somewhat hard of hearing, and I could not help eavesdropping on the conversation of another customer a little way away.

His attention had apparently been attracted by a handsome-looking but somewhat out-of-date all-mains receiver which was offered at a knock-out price in the "bargain-basement" of this particular concern. All went well with the negotiations until it came to the question of whether his supply mains were AC or DC. To my surprise the customer insisted that they were neither; further enquiry elicited from him the fact that his mains were of the universal type and no amount of argument would convince him otherwise.

Eventually the salesman wormed out of him his home address, which proved to be in a well-known AC district and therefore quite suitable for the set he coveted.

After further fruitless argument, however, he departed without the set, firmly convinced that the salesman was a fool.

In a moment of moral weakness

Grouse Shooting Begins

IT seems hard to realise that the annual Wireless Exhibition is only just round the corner because, so far, there seems to have been a marked absence of the usual newspaper stories of wonderful new inventions and secret circuits which are guarded day and night by special squads of ex-C.I.D. men.

I suppose that the truth of the matter is that the publicity agents of certain manufacturers have somewhat belatedly decided that the long-suffering public is at last getting a little weary of these old and hackneyed stunts.

Apart from these fatuous pieces of publicity there are several things at the actual exhibition itself of which I am getting heartily weary. For instance, automatic record-changers of the "single-side eight" type have been with us for a good many years now, and have amply proved their worth, but isn't it about time that their sponsors tried to improve them a bit instead of trying to foist them on us as something new every year? It's absurd to pretend that they don't need improvement, as did one manufacturer at whose stand I addressed a few pungent and personal remarks last year. There is nothing under the sun which cannot be improved, not even excepting the manners of some of the stand attendants, or "engineers" as I believe they prefer to be called by the common or garden visitor.

Another grouse I've got is about the never-ending lunch taken by the one and only technical man which some firms have on their stand. Last year again I was particularly unlucky. I arrived at one stand as the technical man had "just this

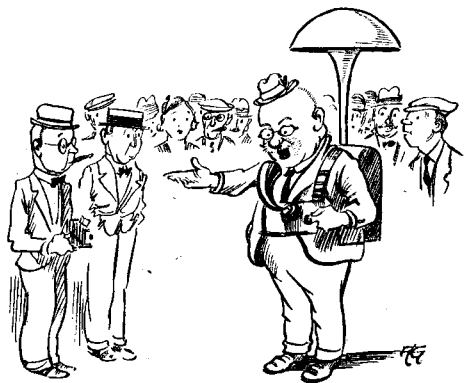

The apparatus was as effective as it was neat

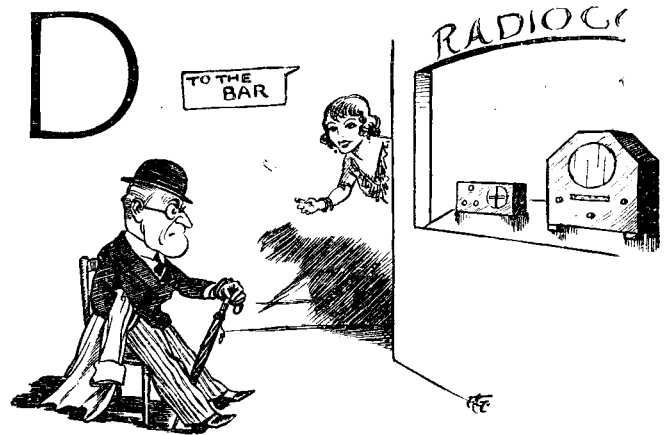

moment gone to lunch, sir." Like Mr. Britling, I determined to see the thing through, and sent one of the little Grid Leaks out to buy a camp stool. After two hours' patient waiting I allowed myself, in a moment of moral weakness, to be led away to the bar by a siren whom the stand manager had evidently detailed off to amuse me. I don't suppose I was gone more than two minutes, but it was just two minutes too long. When I got back to my post it was only to hear the old, old refrain: "Has just gone to his tea, sir."

Rubberneck Amplifiers

MOST people are familiar with the little knots of gaping sightseers surrounding a guide-lecturer which one stumbles across in the Tower and other places of amusement in this and other countries. In most cases the words of wisdom uttered by the lecturer are lost to all save those members of his audience who are immediately surrounding him. The trouble is not so much due to his lack of vocal power as to the fact that he is so hemmed in, for it has been found that a megaphone does little to improve matters, although if he climbs on a stool the problem is at once solved.

However, the necessity of balancing himself on a stool and of constantly hopping from point to point to climb up on it afresh does much to interfere with the smooth flow of his words, and effectively prevents his giving his lecture "on the move," a feature so beloved by American tourists.

It is quite evident that they have fully realised this point on the other side of the Channel, for while there recently I found that the problem had been overcome in a very neat and praiseworthy manner. Draped over the lecturer's shoulders in the manner of a soldier's pack was a complete amplifier, the apparatus being so distributed that the weight fore and aft of his shoulders was more or less equal. From his shoulders rose the loud speaker horn, which was of the mushroom-shaped omnidirectional type, while the microphone was suitably positioned in front of him.

The whole apparatus was as effective as it was neat, and while he was able to address clearly a far larger group of followers than under normal circumstances, his movements were unimpeded.

THE LOUD SPEAKER

Catering for New Demands

THOSE who go to the Show in search of new developments in high-grade moving-coil loud speakers for quality of reproduction will find ample new material awaiting their investigation and judgment. One of the most interesting of the new designs is the Whiteley "Stentorian Duplex." This is a combination of a large-diameter coil-driven cone and a small

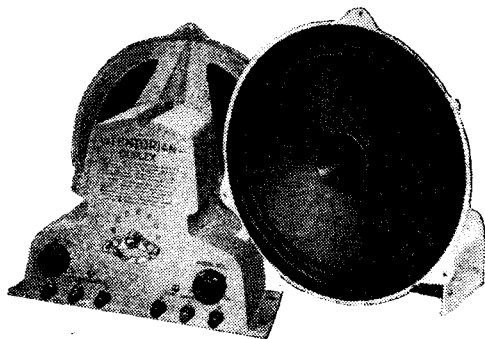

A "tweeter" unit is built into the centre pole piece of the Whiteley "Stentorian Duplex" loud speaker.

horn-type "tweeter" which has been ingeniously incorporated in the centre pole piece of the main cone.

The "Standard" model Hartley Turner loud speaker is being continued, and with the advent of nickel-aluminium permanent magnets the designers have supplemented this with a permanent magnet version. There will be two new Hartley Turner models, one with a re-entrant cone giving a smoother response over a restricted range, and the other with a twin diaphragm designed to cover frequencies up to 12,000 cycles.

The standard of reproduction demanded in light public address equipment for use in connection with small dance bands has been met by Goodmans (Clerkenwell), Ltd., by their "Auditorium" 12-watt permanent magnet loud speaker. This is

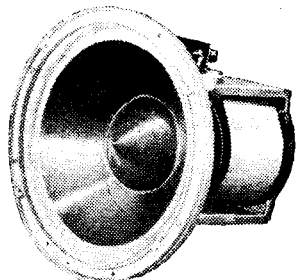

One of the new Hartley-Turner models with re-entrant cone.

fitted with a 12in. diaphragm and the nickel-aluminium alloy magnet provides a sensitivity such that an input of the order of $2\frac{1}{2}$ watts is all that is required for a small dance hall. The Tannoy Band Type PM de Luxe is another reproducer of this type, while the Sound Sales small PA horn, with a permanent magnet unit

designed for a maximum input of 3 to 5 watts will be found suitable for this class of work. Special prominence will be given to outdoor public address equipment on the Tannoy and Film Industries stands, and the latter will be showing a new type of moving-coil microphone with directional baffle.

Tannoy will also be showing a moving-coil speaker, known as the Type HE, in the high-grade class. The British Rola exhibit will include their new Type D12 quality reproducer. Two new extension speakers, a special car radio unit and a comprehensive range of set manufacturer's units will complete the exhibit on this stand.

Among other quality reproducers which will again make their appearance with minor modifications may be mentioned the Haynes "Standard" and "Senior" units, the Celestion "Senior Auditorium," now handled by Cyril French, and the Magnavox "Six-Sixty."

A new Magnavox speaker, which will be introduced by Benjamin Electric, Ltd., is typical of a group of new quality reproducers of intermediate price. This model, which will be known as the "Thirty-Three," has an 8in. diaphragm and is capable of handling 7 watts. It is fitted

Magnavox Model "Thirty-Three"

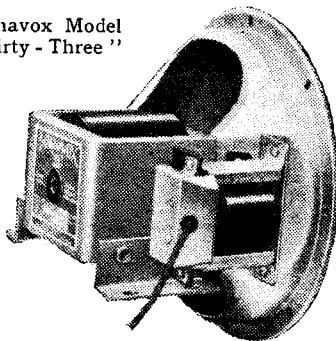

with a hum-bucking coil and the output transformer is mounted at the side of the energised field magnet. Among notable examples of this class may be included the Celestion "Junior Auditorium" permanent magnet and energised units, the Tannoy Type J and the new Epoch "66." The design of the latter is based on the "Domino" unit and the input power is rated at 6 watts.

Permanent-magnet loud speaker units of the type and rating of those incorporated in complete receivers, have undergone many improvements apart from those incident upon the introduction of nickel aluminium alloy magnets. The new Wharfedale "Bronze," for instance, is fitted with an exponentially curved cone, and the Grampian "Pantone" is fitted with a special composite diaphragm reinforced with linen and designed to control "break-up" at the higher frequencies.

The Whiteley Electrical "Stentorian"

range has been fitted with a new design of moulded coil former, and the efficiency has been increased by improvements in the design of the special alloy permanent magnets introduced last year. Modifications and improvements in magnet design

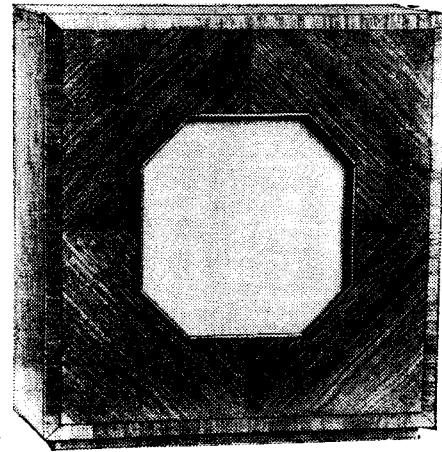

Celestion Junior Auditorium extension speaker.

are also features of the Milnes range of moving-coil units. The R & A exhibit will be divided into three sections fulfilling the requirements of set manufacturers, radio relay systems, and the general public, the latter being catered for by the "Alpha," "Multimu," and "Multex" permanent-magnet units.

Makers of extension loud speakers have kept pace with the general improvement in quality of reproduction in receiving sets which has taken place throughout the year, and examples of really first-class cabinet loud speakers, not necessarily built on a competitive price basis, will be found in the range of Celestion loud speakers shown by Cyril French, in the Goodmans "Grille" extension loud speaker and in the Wharfedale "Queen Anne Cabriolet" model incorporating their "Golden" chassis.

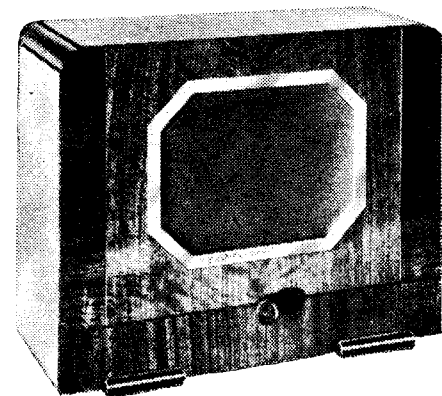

Goodmans "Grille" extension speaker.

Last, but by no means least, the Sono-chorde range of loud speakers, and in particular, the "tweeter," making use of the piezo-electric principle, should not be missed by those in search of quality of reproduction.

The Television Position

Where We Stand To-day

ALTHOUGH great secrecy is being observed concerning the technical side of television, especially as regards the design of suitable receivers, enough can be gleaned to assure us that striking progress has been made. Until essential technical details are divulged designers cannot attempt to produce receivers, nor can we estimate their cost with any accuracy. This article discusses the present state of the new science.



View of the Alexandra Palace, which has been chosen as London's first transmitter site. The top of the south-east tower has been dismantled in preparation for the erection of a transmitting mast.

THOSE who visit Olympia expecting to learn all about the latest developments in television will be disappointed. Olympia this year is to be a radio show again, with possibly even less evidence of television than in previous years. The reason is that the organisers of the Exhibition hold the view that to give wide publicity to television long before the new high-definition service

ing on an equal footing, but there ought to have been a happy mean where television could be included in its proper perspective. The radio industry is, however, right in considering it necessary to protect the public from being persuaded by "clever" salesmen into buying television apparatus at this stage. The expression "at this stage" requires some explanation. What exactly is the stage at which television has now arrived?

The only people in this country who are really competent to answer this question are the members of the Advisory Committee appointed by the Postmaster-General, and now entrusted with the task of "nursing" television through its childhood. This Committee will, no doubt, be disbanded when the child has grown strong enough to be able to take care of itself, but until then it is desirable, in the interests of the new science as well as in the interests of the

at present, namely, Baird and E.M.I. But there will be no information forthcoming from them for publication. They are visitors to every camp, and must keep whatever they are supplied with confidential.

It will be remembered that the Television Committee which preceded the present Advisory Committee recommended that both the Baird and E.M.I. companies should be given the opportunity of tendering to the B.B.C. for the establishment of a transmitting station for London, so that both systems could have an equal opportunity of being tried out. It was then recommended that the receiving apparatus should be capable of receiving both transmissions. This would have meant co-operation between the Baird and E.M.I. companies, but they have found this to be impracticable, so that the position now is that two transmissions will take place alternately with different degrees of definition in the pictures, the Baird Company adhering to the 240-line definition recommended by the Committee as a good basis, whereas the E.M.I. people have elected to start straight off with a higher definition of 405 lines, with interlaced scanning.

Television Receivers

The Alexandra Palace has been chosen as the site for the first transmitter, and work is in progress there now. It is unlikely that any initial transmissions will take place before November, and possibly not until the beginning of next year.

There seems little doubt now that the first receivers will come from the E.M.I. and Baird companies. It is probable—and, indeed, the Television Committee has been almost insistent on the idea—that the radio industry as a whole will have the opportunity of producing television sets under licence from those who hold patents, but it seems certain now that there will be some delay before most of the radio

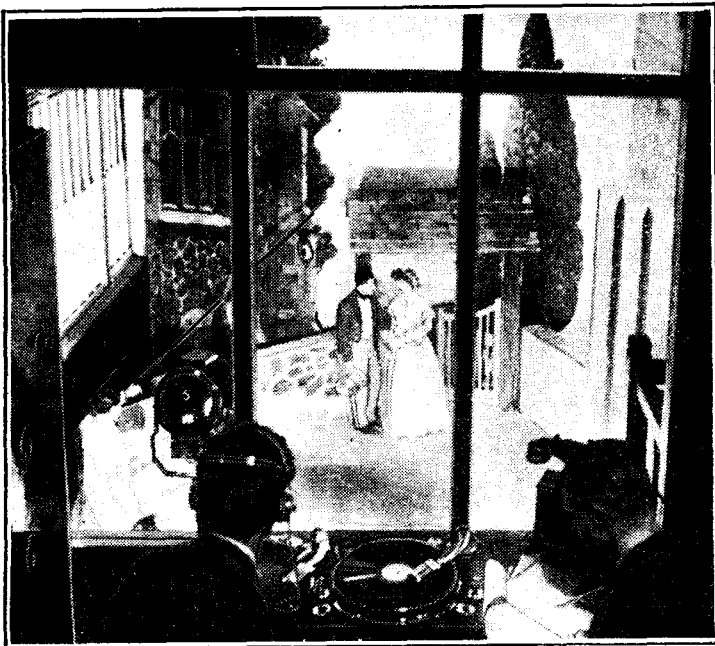

Televising a scene at the Baird Studios at the Crystal Palace with high-definition apparatus.

becomes available would be to mislead the public.

There is much to be said in favour of this point of view. Although everyone would, quite naturally, like to know just what progress television has made, it is not desirable that the visitors to the Exhibition should form the opinion that television has arrived at a stage where it can take its place alongside sound broadcast-

public, that its progress should be carefully watched over.

This Committee could state very precisely where television stands to-day, for the reason that its members have had access to all the information which has been kept secret from others. They have had frequent demonstrations of the television apparatus of the two rival concerns which are principally involved in the game

The Television Position—

firms can get into production with television sets, which is probably one good reason why they have banned television at the Show.

Although so much secrecy has been observed as to the technical progress which has been made, enough can be gleaned to justify an optimistic view on this aspect of the new science. The appointment by the Postmaster-General of a Television Committee undoubtedly served as a great stimulus to commercial and inventive enterprise. When the Committee proposed 240-line definition, it was felt that rather a high standard was being set, yet only a few months later both E.M.I. and Baird had easily been able to exceed this degree of definition. Again it was considered that only scenes in studios could be transmitted direct, and that for other subject-matter film would have to be utilised, yet now both companies have available television cameras, each working on a different principle, which make direct transmission of close-up scenes in the open comparatively easy of achievement. Progress in the design of telephone lines capable of carrying the wide frequency band needed for television has been made, so that linking-up transmitters by this means is no longer a far-off dream. If in major developments such progress has been made in the course of a few months, it is unlikely that improvements in detail have lagged behind, and the future should hold promise of the gradual elimination of all obstacles to technical perfection.

Not much more can be said at the moment, for lack of information, concerning the technical sphere. Possibly the occasion of the Show may be taken to make some statement to the public, or, on the other hand, information may still be withheld in order to spring a surprise when the transmitting station is nearing completion.

Receivers and Their Cost

Various statements have appeared on the question of the probable cost of receivers for the reception of the high-definition television programmes when they start. The Television Committee gave what was, perhaps, rather a high figure when they suggested £50 to £80, because so much technical progress has taken place since then that we may hope that efforts towards a reduction in cost have also been productive of results. As far as we are aware, the E.M.I. Company has maintained complete silence on the matter, but a technical official of the Baird Company has ventured the suggestion that a receiver

giving a cathode-ray tube picture 12in. by 9in., and providing for sound as well as sight, shortly to be available, may in two years' time be priced as low as 30 to 50 guineas. This receiver uses about eighteen valves, and will naturally cost more than the figure given above at first.

However much progress has been made recently behind the scenes, it is not at present likely that the total number of valves required for the combined television and sound receiver can be reduced below, shall we say, the figure of "about 18" given by Baird's. The first reduction will probably come with a simplification of the "time bases" which might reduce the



A television subject as broadcast by the B.B.C. on the low-definition system. The elaborate make-up and strong contrast needed for low-definition television is well illustrated in this picture. With the increase in detail possible with high-definition transmissions this exaggerated contrast will no longer be necessary.

total of valves considerably. But there is the cathode-ray tube to be added and all the associated apparatus, so that cheap television receivers cannot be looked forward to yet awhile. With the present almost complete lack of information regarding the transmission, however, it is as impossible to form any true estimate of the probable cost of the receiving equipment as it is to design the apparatus itself.

It is clearly too early to speculate on what the B.B.C. may have in store in the matter of programme material for television broadcasting. It looks as if anything, or almost anything, which the camera could provide will be available, possibly directly, but at all events through the intermediary of the film. But does the system lend itself to the transmission of complete films, such as the cinema provides, or will a new technique have to be

developed specially for television? One thing is certain. The special technique already employed or in the process of gradual development for the microphone will be unsuitable when combined with sight. The question of duration of television programme items will have to receive special consideration, for it may well prove unsuitable to transmit long items where the constant attention of the home audience is demanded.

Initial Success Important

The B.B.C. will have a very great responsibility to face when the transmissions start because the effect upon the public at the outset will have a profound influence on the extent to which television as an adjunct to sound broadcasting achieves popularity.

It is scarcely necessary to point out that any idea of merely giving the public a sight of close-ups of announcers and those who give us the talks will not do. Even at the outset something more ambitious than this will have to be devised.

Broadcast television will probably have to develop along new lines and provide some form of visual entertainment which is not available in other ways. Experience will teach the B.B.C. what is wanted, and their visual audience must be expected to show a good deal of patience while experiments are being tried out. Much should not be expected at first, but it would be reckless to suggest that suitable material cannot eventually be devised which will provide inducement to purchase sets even at high prices. There are most interesting possibilities just over the horizon, and there should be no feeling of impatience if the horizon at present is some way off. In our modern world things move

so rapidly that what seems remote to-day may be commonplace to-morrow.

BLUE PRINTS

For the convenience of constructors full-sized blue prints are available of the following popular **Wireless World** sets that have been fully described for home construction, price 1s. 6d., post free.

AC Short-wave Converter. (Two-range unit covering 13.5-50 metres.) **April 12th and 19th, 1935.**

Permeability Battery Four. (Long-range receiver with two HF stages.) **May 24th and 31st, 1935.**

QA Receiver. (AC Four-valve HF and detector unit designed to work with Push-pull Quality Amplifier.) **Feb. 8th and 15th, 1935.**

Push-Pull Quality Amplifier. (AC resistance-coupled double push-pull designed for the finest quality of reproduction.) **Feb. 22nd, 1935.**

These can be obtained from the Publishers, Hiffe and Sons Ltd., Dorset House, Stamford St., London, S.E.1.

Listeners' Gu



THE "SEASON" BEGINS

IF there be a "listening season" it begins this week. The concurrence of Radiolympia and the Promenade Concerts may be accidental, but no better matched pair of events could be found to remind everyone that "the air is full of sweet sounds that give delight and hurt not."

Variety programmes reach their apogee with the fine broadcasts from Olympia, while the eight-weeks' Promenade festival, every concert of which will be broadcast, should satisfy every music lover, no matter what the height of his brow.

FIRST BROADCAST FROM RADIOLYMPIA

THE first broadcast from the R.M.A. Theatre at the Wireless Show will be at 8 p.m. on Wednesday next, August 15th, when Regional listeners will hear a high-speed entertainment, organised by John Sharman, with artists selected from the following:—Collinson and Dean, The Radio Three, Norman Long, Elsie and Doris Waters, Claude Dampier and Billy Carlyle, Harold Ramsay at the "Electrone," Parry Jones (tenor), Leonard Henry, Elsie Carlisle and Sam Browne, and Billy Merson and Babs Valerie.

Listeners will be given a word-picture of all that happens on the stage at Radiolympia, so only a little imagination will be required to

THE FUN OF THE FAIR.

Once again the R.M.A. Theatre at Olympia will be besieged by listeners eager to see their favourites in the flesh. The shows will be broadcast on August 14th, 17th, 19th and 24th. Artistes taking part include Elsie and Doris Waters (within the arch) and (left to right) Leonard Henry, Norman Long, Anona Winn, and Henry Hall, who directs the B.B.C. Dance Orchestra.

share the excitement of the people in the front seats.

FIRST WEEK OF THE "PROMS."

THE programmes for the first week of the Promenade Concerts contain many favourites.

To-morrow night (Saturday) the opening concert includes the famous overture to "The Bartered Bride" by Smetana, Handel's "Largo in G," and Elgar's "Enigma Variations." For the Wagner concert on Monday music from "Tannhauser," "Die Meistersinger," "Götterdämmerung" and the "Siegfried Idyll" will be broadcast. The Tchaikowsky concert on Tuesday features the Pianoforte Concerto No. 1, "Sérénade Mélancholique" for violin and orchestra, and the Fourth Symphony. Wednesday is a Bach-Handel night with the Brandenburg Concerto No. 2 and the Pianoforte Concerto No. 1 among the Bach items, while Handel is represented by Concerto Grosso No. 4 and other pieces. The early part

of Thursday's programme will be for the first time entirely devoted to Debussy and Ravel, the outstanding pieces being the latter's Pianoforte Concerto and "L'après-Midi d'un Faune" by Debussy.

The concerts are being broadcast as follow: Saturday, National, 8; Monday, National, 8; Tuesday, Regional, 9; Wednesday, National, 8; Thursday, National, 8.

AT THE ZOO

ALTHOUGH busy in preparation for Radiolympia, Elsie and Doris Waters will find time to feature in "Zoo 'Oliday," a revue by Ashley Sterne and Elsie Waters, to be broadcast on Monday (Regional, 8) and Tuesday (National, 8.40).

As Gert and Daisy the famous comedienne will be encountered in a number of amusing, not to say embarrassing, situations. They will, of course, visit the monkey house, and it

"LIFE BEGINS AT 8" is the title of Kalundborg's relay to-night from the Summer Theatre, Elsinore. Here are the "Margrethes" who will perform the Danish dance hit, "Watch your heart, Margrethe."

seems that Edie, Daisy's unpleasant off-spring, nearly gets drowned in the Canal.

In addition to Elsie and Doris Waters the cast will include Wynne Ajello, Patrick Waddington, Charles Higgins, Stuart Robertson and John Rorke. The music has been specially written by Ashley Sterne and will be played by the B.B.C. Variety Orchestra.

A STREET SINGER

PAT O'BRIEN, an Irish street-singer for whom great things are hoped, appears in Ernest Longstaffe's revue, "Sourires et Chansons," Thursday, (Regional, 8). Since smiles and songs are two of the essential ingredients of any variety show, the title is apt. The translation into French is perhaps intended to enable Yvette Darnac, the well-known Anglo-French diseuse, who will commère, to understand what she is talking about. Hildegard will sing a new Viennese waltz, and Edwin Lawrence will give impersonations in this his first broadcast.

Another début will be that of Anita Lowe—a diminutive red-hot momma.

J. H. AMERS

A NAME very familiar to listeners of ten years ago, J. H. Amers, appears in next Sunday's programme. Colonel Amers will take the place of B. Walton O'Donnell, B.B.C. Military Band conductor, who will be on leave. In the early days J. H. Amers and the R.A.F. Band toured the B.B.C. stations.



Guide for the Week

Outstanding Broadcasts at Home and Abroad

HIGHLIGHTS OF THE WEEK

FRIDAY, AUGUST 9th.

Nat., 8, The Air-do-Wells. 9, Violin Recital by Samuel Kutcher. 9.50, Ernest Newman talks about the Promenade Concerts. Reg., 8, Scarborough Spa Orchestra. 9, B.B.C. Dance Orchestra. 10.30, Jack Jackson and His Band.

Abroad.

Munich, 9, Bavarian Folk Music.

SATURDAY, AUGUST 10th.

Nat., 8, First Promenade Concert. ¶Ambrose and His Embassy Club Orchestra.

Reg., The Mystery of the Seven Cafes. ¶New Songs for Old.

Abroad.

Radio-Paris, 8.45, Opera: "Cinderella" (Massenet).

SUNDAY, AUGUST 11th.

Nat., Middlesbrough Silver Prize Band. ¶Troise and His Mandoliers. ¶Bournemouth Municipal Orchestra, conducted by Richard Austin.

Reg., B.B.C. Military Band. ¶B.B.C. Orchestra. ¶Medvedeff's Balalaika Orchestra. ¶The London String Players. Soloist: Leon Goossens (Oboe).

Abroad.

Kalundborg, 9.15, "Haffner" Serenade (Mozart) by Radio Orchestra.

MONDAY, AUGUST 12th.

Nat., B.B.C. Military Band. ¶From the London Theatre. ¶Wagner Promenade Concert. ¶Bernard Crook Quintet.

Reg., 8, "Zoo 'Ooliday"—Ashley Sterne Revue. ¶B.B.C. Orchestra, conducted by John Barbirolli.

Abroad.

All French Stations, 8.45, Concert from the Vichy Casino.

TUESDAY, AUGUST 13th.

Nat., B.B.C. Dance Orchestra. ¶The Celebrity Trio. 8.40, "Zoo 'Ooliday." ¶Part II of Promenade Concert.

Reg., 8, Promenade Concert, Part I. ¶Glees and Part Songs by the B.B.C. Singers.

Abroad.

Munich, 8.10, Ibsen's "Lady of the Sea."

WEDNESDAY, AUGUST 14th.

Nat., Fred Hartley and His Novelty Quintet. 8, Bach Promenade Concert. ¶Transatlantic Bulletin (from America). ¶Leslie Bridgewater's Quintet.

Reg., 8, Variety from Radiolympia. ¶"Pleasant Portion"—Radio Drama by Barbara Couper.

Abroad.

Brussels II, 8.30, Schumann and Schubert Concert.

THURSDAY, AUGUST 15th.

Nat., Alfredo Campoli Trio. 8, Ravel-Debussy Promenade Concert. ¶Gershom Parkinson Quintet.

Reg., "Sourires et Chansons," by Ernest Longstaffe. ¶Choral and Orchestral Concert, by B.B.C. Chorus and Orchestra.

Abroad.

Brussels I, 8, Orchestral Programme of Mozart's Works.

BUFFS' SERVICE OF REMEMBRANCE.

On Sunday at 12.15 p.m. the Buffs' Service of Remembrance will be relayed from Canterbury Cathedral. This year the service will include the laying up of the old Colours of the Fifth Battalion. Very appropriately the Colours will be handed over to the Dean by Colonel J. Body, D.S.O., who led the Fifth Battalion into Bagdad.

THE MERRY WIDOW.

LEHÁR's "Merry Widow" celebrates her thirtieth birthday this year, but remains as sparkling and seductive as ever, to judge by her continued round of triumphs in every

FROM SALZBURG CATHEDRAL

The third of the great sacred concerts in the Salzburg Festival is to be relayed from the Cathedral at 8.40 p.m. on Sunday. The programme consists of Bach's "Actus Tragicus," Handel's "Hundred Psalms," and Mozart's "Coronation Mass." The Cathedral Choir and Orchestra will be conducted by Joseph Meissner.

FOLK MUSIC.

NATIONAL and folk music has a large share of the Continental programmes this week. Tonight at 9 Munich relays Bavarian folk music from Kulmbach, in the Bayreuth district.

There is a large choice to-

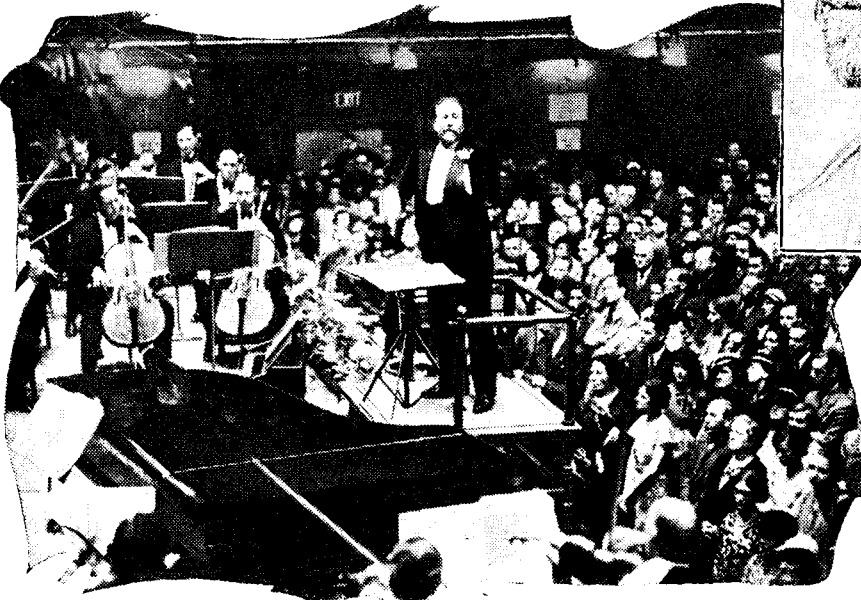

"PROMS." The Promenade Season begins to-morrow (Saturday) at the Queen's Hall, and all or part of every concert will be broadcast. Inset: Sir William Rothenstein's new portrait of Sir Henry Wood, who will be conducting his forty-first series of "Proms."

European capital. The operetta is being broadcast from Budapest at 8.10 on Saturday.

Leo Fall runs Lehár pretty close as an operetta composer of international repute. In fact, his "Merry Peasant," which Brussels (No. 2) is broadcasting from the Exhibition on Sunday evening at 8 o'clock, is almost as old and as hardy a perennial as "The Merry Widow," having been performed first in 1907.

FESTIVAL TALK.

"SALZBURG—the Festival Town" is the title of a broadcast talk in English which is being given by Vienna on Sunday next at 7 p.m. The talk is being relayed to the Columbia Broadcasting System of America.

At 6.15 Moscow gives a recital by a Domra (a Russian folk instrument) ensemble; at 7.25 Beromunster has Swiss folk music, and at 8.10 Hamburg offers sailors' yarns and sea shanties. At 8.15 Sottens gives a yodelling recital, and at 9.30 a recital of negro spirituals comes from Prague.

"PULL-PLAYING."

The accordion can be handled in many ways, ranging from the lilting style of the cowboy to the flamboyant method of the tango band soloist. Swedes, however, have a system which is quite their own; indeed, Swedish folk music contains a rich variety of special compositions for Dragspel, or "pull-playing," as it is called in Sweden.

evening's programme from the Summer Theatre, at Elsinore, to be relayed by Kalundborg from 8 to 11. The programme should be a good one all through, comprising the cream of the season's dance hits.

THE AUDITOR.

30-LINE TELEVISION

Baird Process Transmissions. Vision, 261.1 m.; Sound 296.6 m.

MONDAY, AUGUST 12th. 11.15—12.0 p.m.

Pearl Rivers (Songs and Dances); Reana (the Snake Girl): Robert Algar (Songs); Tom Devine (Dances).

WEDNESDAY, AUGUST 14th. 11.0—11.45 p.m.

Harold Stern (Songs); Hermione Dainborough (Dances); Stanley Judson (Dances); Fedora Roselli (Soprano); Reginald Paul at the Piano.

HINTS and TIPS

Practical Aids to Better Reception

WHEN carrying out experiments with a view to increasing the sensitivity of a receiver, most amateurs have one handicap in common: their only means of observing the effect of any adjustment is that notoriously unreliable organ, the human ear.

Neon Output Indicator

Whilst everyone will admit the obvious advantages of a calibrated output meter for this purpose, it is argued that such an instrument is so rarely needed as to be an unjustifiable luxury. Nevertheless, it is extremely useful to have always at hand some form of output indicating device which need not be accurately calibrated nor ultra-sensitive as long as it gives a visible comparison between signals of different intensities.

From the economy and simplicity point of view, the neon type of tuning indicator, widely used at the present time, would seem to be ideal, and the circuit connections of a simple output indicator incorporating one of these tubes is shown in Fig. 1.

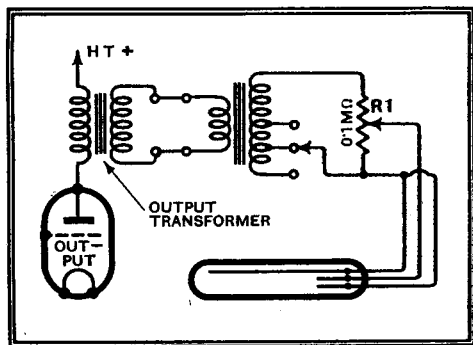

Fig. 1.—Explaining the use of a neon tuning indicator as an output meter.

The input transformer, which is necessary to step up the audio voltages, may conveniently be a conventional tapped-primary output transformer used the reverse way round, while the potentiometer R1 should preferably be a well-made component with a free movement. This potentiometer provides a critical control of the voltage actually applied to the neon tube, and by calibrating the dial in arbitrary units quite accurate output readings may be taken. For example, assuming that the unit is being fed with a steady signal from the receiver under test, R1 is first adjusted so that the tube just commences to glow. Any change in output volume as the result of any adjustment will now either cause the glow to go out or to spread along the tube. If the glow extends almost the full length of the tube, obviously a considerable increase in sensitivity has taken place, the extent of which may be measured approximately by readjusting R1 until the tube once more only just glows, and then noting the new setting of the calibrated dial.

A CERTAIN amount of risk always exists when a number of parallel-connected valves are fed from a source of higher voltage (from, say, a car battery) than their rated filament voltage. In such circumstances no valve should be removed from its holder without first switching off the LT supply.

High-voltage Filament Supply

The reason for this precaution is that a series resistance is necessary in such circumstances for absorbing the surplus voltage. When the number of valves in circuit is reduced, there will be a corresponding reduction in the voltage absorbed by the resistance, and so the remaining valves will be overloaded—possibly to such an extent that their filaments will be burnt out.

WHEN making adjustments or tests of the HF or detector circuits of a receiver it is usual to recommend that volume should be reduced; this can often be done most satisfactorily by cutting down the input from the aerial. In this way the effect of any alterations can more readily be appreciated as the ear is most sensitive to small changes in intensity of a signal that is initially weak.

Full Volume Tests

With regard to loud-speaker tests, however, those who are best qualified to hold definite opinions on the matter seem always to adopt the opposite course and to "turn up the wick" to full volume, or even to a point where overloading has already set in. Any fault or deficiency in the response of the loud speaker, particularly in the shape of resonances, is then more easily detected.

IN following any published design, such, for example, as the "AC Short Wave Converter," the constructor sometimes chooses to make up his own metal chassis; in doing so he will be wise to use the greatest care in the preliminary marking out of the centres for all the various holes to ensure that everything fits according to plan. Some kind of

Accurate Chassis Marking

punch to make a hole for locating the point of the drill is, of course, essential, but in the measuring and marking out process which leads up to the actual centre-punching, amateurs are often guilty of allowing appreciable errors to creep in by making shift with the nearest

available pointed tool as a substitute for a scriber.

It is usually more satisfactory to possess the right tool for every purpose, but, failing the possession of a proper instrument-maker's scriber, it is useful to know that a very handy substitute may be improvised from almost any propelling pencil, merely by removing the lead point and replacing it by a fine (soft tone) gramophone needle.

WHILST its number of pins can hardly be considered to affect the ease with which a valve may be persuaded to enter its valveholder, it is a fact that the re-insertion of 7- and 9-pin valves becomes difficult enough to be exasperating when (as in some compact chassis designs) it is not possible to get a clear view of every holder.

Inaccessible Values

When changing or testing valves in a case of this sort, time and temper may often be saved by marking the position of each inaccessible valve in some way before removing it; then, by matching two corresponding marks, the pins will slip back again easily into their correct sockets (see Fig. 2).

The marking may be done in various ways, such as by lead pencil (hardly effective on non-metallised valves), labels of adhesive paper, or little dabs of quick-drying paint. The last-mentioned method is certainly the neatest, and lends itself well to a system of marking by numbers which can be useful in other ways.

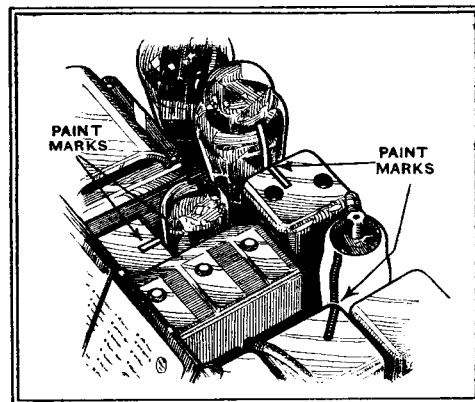

Fig. 2.—Guide marks as an aid to the correct insertion of valves.

For example, if the respective valves in a 5-valve set are marked before removal with the numbers 1, 2, 3, 4, 5, any likelihood of reinserting them in incorrect positions is remote, and risk of mixing up old and new valves is avoided.

Notes on the 1936 MONODIAL AC SUPER

Getting the Best Out of the New Receiver

THE performance of any receiver depends not only upon its design but upon the way in which practical form is given to that design. Not only is it important that the various components comprising the receiver are suited to the work which they must do, but they must be so arranged physically that they do only this work and do not also function in unwanted ways to cause instability or other defects. The choice of components and layout is, of course, a part of the design, and a very important part. There are certain elements, however, which fall outside the receiver proper and in which a certain latitude is permissible. The loud speaker is one item of this nature. No two speakers are exactly alike, but there are many cases where the differences are not great enough for the performance to be much altered which ever be chosen, provided that each be used correctly. Since the speakers are different, however, each requires somewhat different treatment if it is to give of its best.

The N41 output valve requires a load impedance of 6,000 ohms, so that the output transformer must be of the correct ratio to present this load to the valve with the particular speaker used. A figure for the average speech coil impedance should be obtained from the makers, and the transformer ratio can then be calculated by dividing 6,000 by the speech coil impedance and taking the square root of the result. When the speech coil impedance is less than 6,000 ohms, as is nearly always the case, the transformer is of the step-down type. Thus if we have a speaker of 8 ohms impedance, the correct ratio is $\sqrt{6,000/8}=27.4-1$. The W.B. Type EM/W speaker specified is fitted with a multi-ratio transformer and as the speech

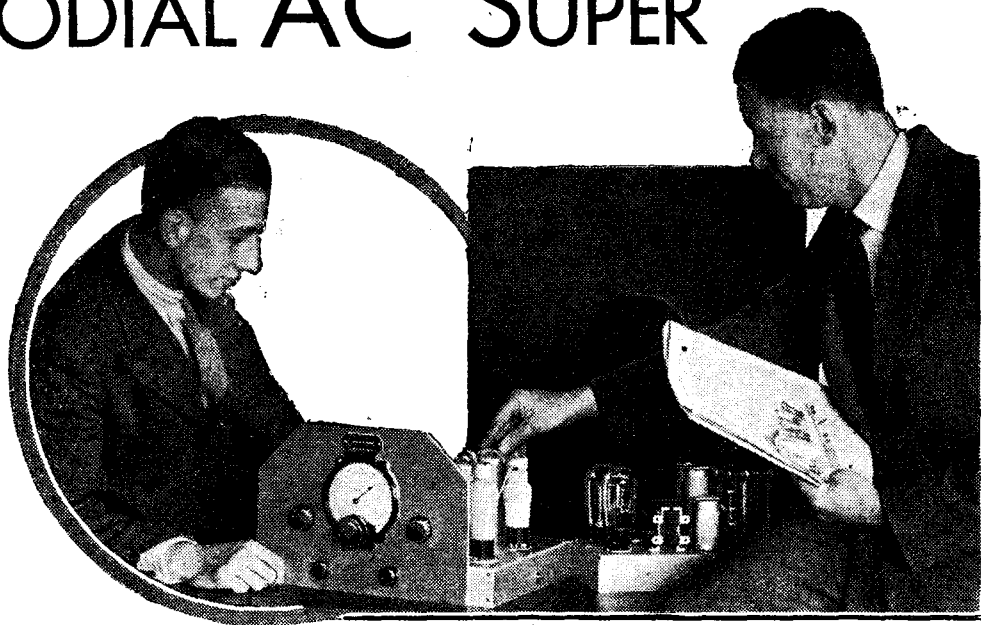

coil impedance is 18 ohms the ratio should be 18.15-1 and the nearest tapping giving a ratio of 17-1 should be used.

The mains equipment is designed so that the speaker field forms a part of the smoothing equipment and is energised from it. The field winding, therefore, must have a resistance of 1,250 ohms and take a current of 120 mA. It is unimportant whether a humbucking coil be fitted or not. The connections between the speaker and the speaker plug are shown in Fig. 1 (a).

***FURTHER** details about setting up the 1936 Monodial AC Super, constructional details of which appeared in the last two issues of "The Wireless World," are given in this article. It will be remembered that this receiver is a highly sensitive and selective superheterodyne incorporating the latest developments and fitted with variable selectivity to permit a very high standard of reproduction being obtained.*

gisation alone is concerned the arrangement of Fig. 1 (c) is entirely satisfactory, and it will be seen that the field is shunted by a 2,500 ohms resistance which must be rated for 10 watts dissipation. The presence of this resistance, however, greatly reduces the effectiveness of the speaker field as a smoothing choke, with the result that these connections may lead to mains hum being introduced. This may not always occur, so that although these connections cannot be guaranteed to be successful in all cases, they are worth a trial where a speaker of 2,500 ohms field resistance is available.

The connections shown in Fig. 1 (d)

cover the permanent magnet and separately energised types of loud speaker. Here no use is made of the provision for energising a field winding, and the only connections to the speaker are those to the transformer primary. In order to obtain adequate smoothing a choke having characteristics similar to those of the speaker field must be joined to the two pins on the "speaker-plug" to which a field winding is normally connected. The choke must have an inductance of some 30 H at 120 mA and a DC resistance of 1,250 ohms, and it may be mentioned that a suitable model is obtainable from Sound Sales.

Operation on Gramophone

The next accessory deserving of mention is the gramophone pick-up. Any good quality instrument may be used, but the amplification is hardly adequate for the less sensitive types of needle-armature pick-ups. Owing to the omission of any corrector circuit in the output stage, for such a corrector would be out of place in radio reception, the reproduction of gramophone records may at first be too shrill. It is fortunate, therefore, that correction for gramophone only may be secured by the very simple expedient of connecting a resistance across the pick-up terminals. The value of this resistance must be found by trial, since it will depend upon the characteristics of the particular instrument employed, but it will usually be found to be of the order of 100,000 ohms. In any case, it is as well to remember that a reduction in the value of the resistance will reduce the high-frequency response. It will, of course, also reduce the sensitivity, but this should be unimportant with a component of average sensitivity.

1936 Monodial AC Super—

It should be pointed out that the pick-up leads are not at the same steady potential as the chassis, but about 70 volts positive with respect to it. Since one lead is at the same AC potential as the chassis, this should not lead to any trouble from hum pick-up or feed-back effects, although the usual precaution of screening the leads should be observed. Care should be taken to see that the insulation of the leads is adequate, however.

The aerial and earth system should, of course, be good if the best results are to be obtained. The earth cannot be too good, and should be made as good as local conditions permit. A high resistance earth connection may lead to instability, since the effectiveness of the screening is greatly reduced if the chassis and all parts connected to it are not maintained at the same high-frequency potential. The aerial, however, can be too good in certain circumstances. A poor aerial will naturally lead to poor results, even although the set may be sensitive enough to permit the reception of a number of stations. If the signal input to the set is inadequate, and this is provided by the aerial, more amplification is needed to give normal volume than if the signal input reached a normal figure. Consequently, the ratio of set noise to signal is increased and there is a danger of background hiss becoming noticeable. With an aerial of normal efficiency such hiss is only noticeable on the very weakest of signals.

It is only possible to erect too good an aerial in cases where the set is being used near to a local station, and it may be too good because it provides such a large input to the set from this station that the early valves become overloaded. When valves are overloaded they inevitably generate harmonics, with the result that not only may distortion appear but also whistles. In the few cases where this happens, the remedy is to employ a less efficient aerial, and it may be remarked that it is usually simpler to change the value of C_1 than to alter the aerial itself. A smaller capacity than the normal for this condenser is effective in reducing the input to the set, and conversely when a poor aerial is used this condenser may sometimes be advantageously increased in capacity. Not always, however, for much depends upon the capacity of the aerial itself. It

should be pointed out that the aerial circuit must be re-trimmed if any alteration be made to C_1 ; this, of course, involves the readjustment of the trimmer on C_3 .

Ganging

The initial adjustments and the performance of the receiver have already been fully described in the constructional articles,* but it may be as well to stress the importance of obtaining accurate trimming and ganging if the best results are to be secured. Inaccurate trimming of the IF circuits will inevitably reduce the adjacent channel selectivity and the sensitivity, and the former will be the more noticeable. Bad ganging, however, while likely to affect the sensitivity, particularly at certain dial settings, will not greatly affect the adjacent channel selectivity. Its worse effect undoubtedly will be to render the receiver liable to whistle production

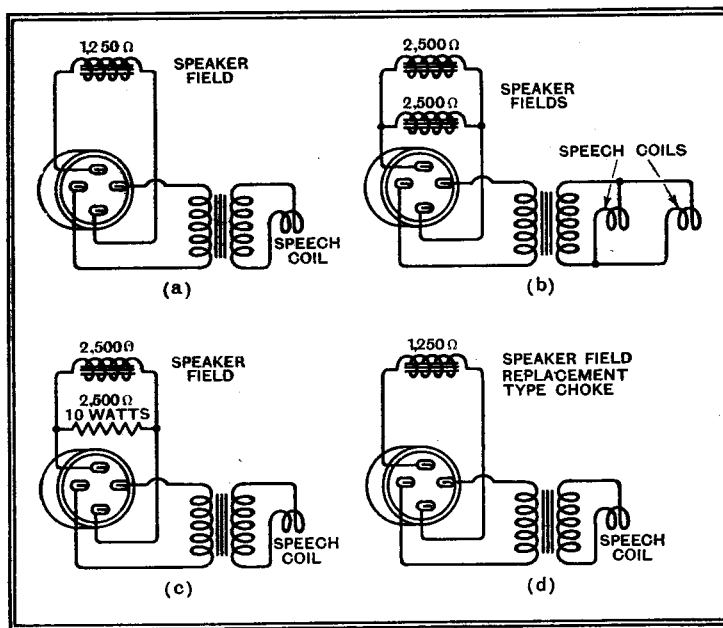

Fig. 1.—The connections between the loud speaker and the speaker-plug are shown at (a) for a 1,250-ohms field type, at (b) for dual speakers with 2,500-ohms fields, at (c) for a single 2,500-ohms field winding, and at (d) for a permanent magnet or separately energised speaker. As explained in the text, the connections of (c) are not always entirely satisfactory, since the resistance reduces smoothing.

through the reduction in the degree of pre-selection.

It should not be thought from this that the initial adjustments are in any way difficult. They are not, and if the instructions already given are carefully followed, anyone may tackle the job and be confident of obtaining the correct results. As in everything else, however, there is a right way of doing it. It is not impossible to obtain correct results by following a different procedure from that recommended but it is more difficult.

The receiver should be completely free from mains hum, and as already stated, background hiss generated in the set itself should not be noticeable on any worthwhile station. The sensitivity and selec-

* *The Wireless World*, July 26th and August, 2nd, 1935.

tivity should be found adequate for the reception of really distant transmissions even in the present congested state of the ether, while the quality of reproduction can, by virtue of the variable selectivity, always be as high as interference conditions permit.

NEW BOOKS

The Fundamentals of Radio. By R. R. Ramsey, Ph.D. Pp. vi+426. Ramsey Publishing Co., Bloomington, Indiana. Price \$3.50.

The scope and nature of this book conform truly to the title, giving the fundamental theory as it applies to practice. Although the author has made a point of avoiding mathematics as far as possible, calculus and differential equations are included in some sections, and the reader is assumed to possess some technical and mathematical knowledge.

In the main the book is very well planned. There are, however, one or two points open to criticism. For instance, it is noted that a few of the drawings are reproduced from rather untidy free-hand sketches—it is a pity to spoil the ship for a ha'p'orth of tar! Also the proof reading might have been a little more rigorous, for printer's errors are not conspicuous by their absence. Apart from these minor points the book is of a high standard.

The text is well balanced, theory and practice being admirably blended. It is thoroughly up to date and includes chapters on television and talking films. O. P.

Television. By M. G. Scroggie, B.Sc., A.M.I.E.E. Pp. 68. Blackie and Son, Ltd., 50, Old Bailey, London, E.C.4. Price 3s. 6d.

This little book is specially written for those who require a simplified explanation of television and "how it works." For the non-technical reader with a scientific turn of mind, and for the radio amateur now turning his attention to television, it would be hard to find a book more suitable. It describes in particularly simple language, with the use of many convincing analogues, the fundamental principles involved and some of the more important systems of today. The illustrations are exceptionally clear and very well produced. O. P.

OLYMPIA RADIO SHOW, 1935

WEDNESDAY, AUGUST 14 TO
SATURDAY, AUGUST 24
11 a.m. to 10 p.m. daily

**TWO FURTHER
SPECIAL SHOW NUMBERS**

OF
"THE WIRELESS WORLD"

**AUG. 16: COMPLETE
SHOW REPORT**

A Stand-to-Stand account compiled by the technical staff of *The Wireless World* and fully illustrated.

**AUG. 23: REVIEW
OF THE SHOW**

A considered analysis of the new season's apparatus based on careful study and comparison of the exhibits by *The Wireless World* technical staff.

NEW COMPONENTS

Latest Developments to be Seen at the Exhibition

IT has been the policy of manufacturers during the past few years to market new components as the designs were perfected, or whenever a new idea in receiving technique required, for its further development, parts not hitherto available. This policy is unquestionably the most satisfactory and best meets the requirements of those engaged in radio research, yet it tends to detract from Radiolympia some of the excitement that obtained in the early days, when manufacturers assiduously stored up new parts in readiness for the annual show.

Components that made their debut during the past year can rightly be classified as "new" by the makers, for they represent the individual firm's contribution to the store of parts that will be used in sets of the immediate future.

As distinct from essentially new components there are the usual seasonal improvements to existing lines to take into account, and this year the modified versions of last season's models will be found every bit as interesting as the new parts.

Coils and condensers, constituting as they do the heart of a radio set, have in the past been the subjects for special attention, and whilst several new models will be seen, development in this field is not exclusively directed towards enhancing the goodness of the coils, though improved types will still be well in evidence.

Sound Sales variable selectivity IF transformer.

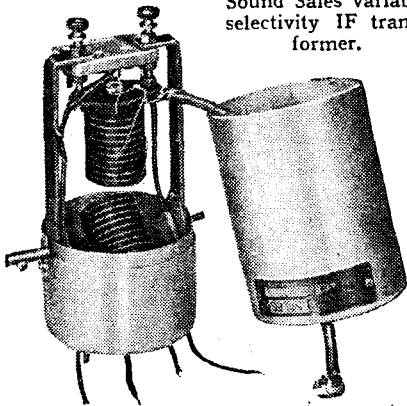

They will be shown by Bulgin in the form of skeletonised types, without switches, but screened and designed for chassis mounting, the soldering tags being arranged in a ring on the base of the coil for sub-chassis wiring.

Wearite will have an air-cored model based on the design of their Universal coil and a new series with iron-cores in compact form and including waveband switches arranged for ganging. Formo has developed a new series of iron-cored coils and Burton will have several models for examination.

Intermediate frequency transformers have received the greatest amount of attention, the very latest type being adapted for

varying the band width of the IF amplifier's response from the control panel.

Variable selectivity IF transformers, as these components can be described, will be shown by Sound Sales, who make their debut as HF coil makers with this model.

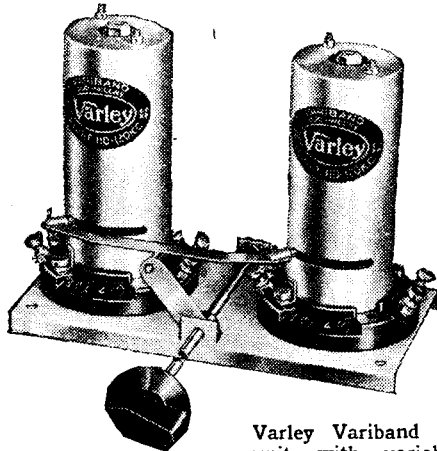

Varley Variband IF unit with variable selectivity.

It is designed for a frequency of 465 kc/s, has Litz-wound coils, well sectionalised, and the two trimmers are mounted at opposite ends of the assembly.

Wearite will show a model for 465 kc/s also, embodying section-wound Litz coils and well-spaced trimmers. The Variband IF transformer, a new Varley product, is a variable selectivity model designed for 110 to 120 kc/s, and there will be a new Bulgin transformer embodying this principle, but designed for 450 kc/s.

Higher Intermediate Frequencies

That interest is focused on the higher frequencies for IF amplifiers, due no doubt to the increasing popularity of the all-wave type of set, is exemplified by the number of new transformers designed for this frequency. In addition to Bulgin's variable selectivity model there will be a companion with a fixed coupling for 450 kc/s, and Varley also will show one for 465 kc/s having pre-set control of the band width and air-dielectric trimmers.

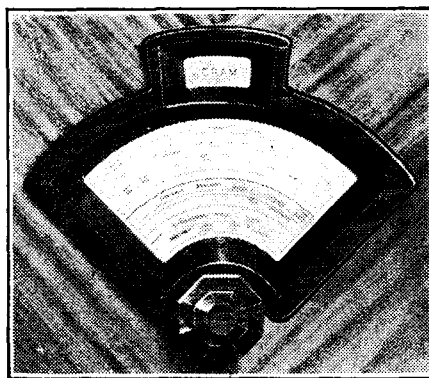

C.A.C. Scanning Disc tuning dial.

A Ferrocart IF transformer for 450 kc/s will be included in the Colvern series, whilst Stratton has a new Eddystone 450 kc/s transformer with air trimmers and Litz-wound coils.

The Permeability tuner evolved by Varley will be available this year in three- and four-gang types, for superheterodyne and for straight circuits.

Gang condensers have not changed materially since last year; Polar has introduced a four-gang model of their Midget type, which will be seen with and without an oscillator tracking section, and Jackson Bros. will have a new Baby-gang model with the rotor supported in ball-bearings. The series includes models with oscillator sections shaped for tracking with 465 and 473 kc/s IF amplifiers. This firm will be showing also a complete new range of dials, including an airplane type

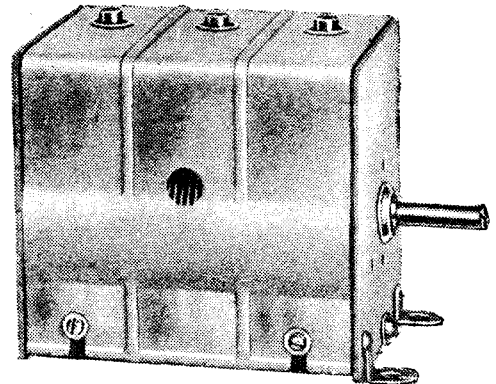

Polar midget three-gang superhet condenser.

with circular scale and two-ratio reduction drive of 8 to 1 and 100 to 1 respectively.

The Polar range of dials remains substantially the same, so do the Ormond models, and this firm has, in addition, a long range of variable condensers, including some gang types.

A dial of particular interest will be seen on the C.A.C. Stand, it is described as the Scanning Disc tuning dial, and one of its principal features is the spreading of both medium- and long-wave bands over two concentric scales in each case, thereby doubling their effective length. A moving spot of light, traversing each of the scales in correct sequence, is employed in place of the customary pointer.

There will be a new Formo dial in which the pointer moves over 270 degrees of the dial for a 180 degree rotation of the condenser. It is known as the Snail Dual Ratio Drive, the coarse control giving an 8 to 1 reduction, whilst the other is of 64 to 1, so that it is particularly well suited for use in all-wave sets.

The synthetic type of resistor with wire-ends is still the predominating type for low wattage dissipation. They will be

New Components—

shown by Bulgin, Dubilier, Erie, Ferranti, Formo, Graham Farish and Polar-N.S.F.

There will be a new Erie series in which the resistor, which is of the synthetic type, is encased in a porcelain shell, so that the whole can be completely insulated by sleeving the connecting wires. A good selection of wire-wound models will be available for heavy-duty work, including some designed especially by Bulgin for DC and Universal mains sets. In the Erie

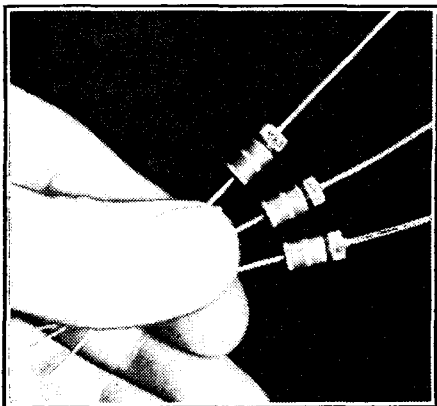

New Erie midget resistors with insulated sleeves.

range the five-watt type and larger are all wire-wound.

During the past year a new type of fixed condenser made its appearance. Dubilier introduced some of the first models, which consisted of impregnated and oil-immersed paper dielectric condensers for high-voltage circuits. The range has since been extended and now includes models rated at from 1,000 to 4,000 volts DC working, the test voltage in every case being twice the working potential. These are small and compact for their class and will be shown in capacities ranging from 0.02 mfd. to 4 mfd.

High-voltage paper condensers will be included in the exhibits of Sound Sales, T.M.C.-Hydra and T.C.C., while wet and dry electrolytics for HT smooth-

ing are to be shown by Bulgin, Dubilier, Ferranti, Polar-N.S.F. and T.C.C.

Formo will have a range of oil-immersed condensers in compact tubular cases with screw fixing and with a working potential of 350 volts DC. Small tubular paper-dielectric condensers with wire-ends for suspending in the wiring retain their well-merited popularity, as will be evidenced by the wide choice available. Some small changes have been effected, but on the whole they remain much the same as last year. Bulgin has evolved a somewhat modified version, described as the "Z" series; these have a wire connection at one end and a small screw protruding from the other for chassis mounting. Eddystone has utilised the metal container as one connection for the condenser for some time past, and this style will be shown this year.

There will be a new range of Dubilier tubulars for 400 volts DC working and having a test voltage of 1,000 DC. Further examples of tubular condensers will be the Graham Farish, Polar-N.S.F., T.M.C.-Hydra, and the T.C.C. makes. Cylindrical containers, some with wire-ends and others with soldering tags, embodying low-voltage electrolytic elements for use in grid bias circuits, will be as well in evidence as formerly, and most of the well-known condenser makers will include a series this year.

Detailed improvements will be seen in most makes of mains transformers and chokes. Models designed for higher voltage and larger wattage outputs will constitute the main points of interest, though cleaner

external appearance, brought about by total enclosure of the winding, will be a feature of this season's models. Notable examples of this pattern are the Davenset, Heyberd, Sound Sales and Wearite models, but a wide selection of the open type will be available also, among which may be mentioned such makes as All-Power Transformers, Ferranti, Kingsway Radio, and Varley, whilst a series of skeletonised chokes will be shown by Bulgin.

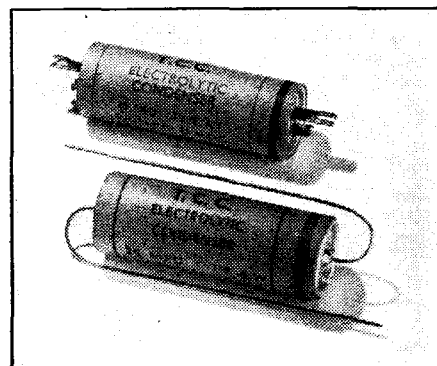

New series T.C.C. low-voltage electrolytic condensers.

Power for operating a receiver from supply mains of a different type from that for which the set is designed, such as AC sets from DC mains, necessitates the use of a converter, and machines for this purpose will be a feature of the Electro-Dynamic Construction Co.'s exhibit. This will include a portable petrol-driven outfit for generating current to operate public address apparatus, also a small alternator that can be housed under the bonnet of a car, or van, and driven by the car engine.

With this class of apparatus we might include service station charging equipment, since this is essentially mains operated. Two distinct types of chargers will be seen and these can be divided broadly into two categories, machine-driven generators and non-rotary rectifier equipment respectively.

Examples of the former are the Reliance series made by A. Diggle and the Crypto

Wearite short-wave frequency meter.

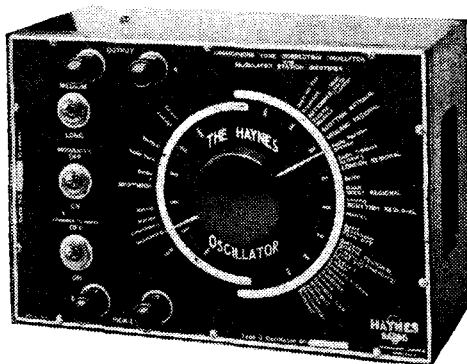
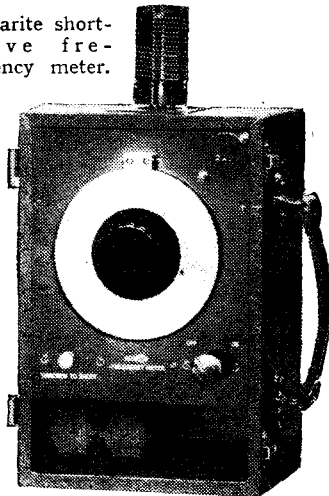

Haynes modulated oscillator for station identification.

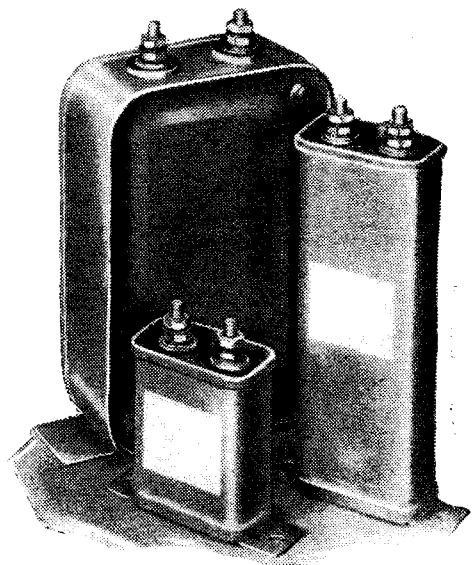

Dubilier oil-immersed paper dielectric high-voltage condensers.

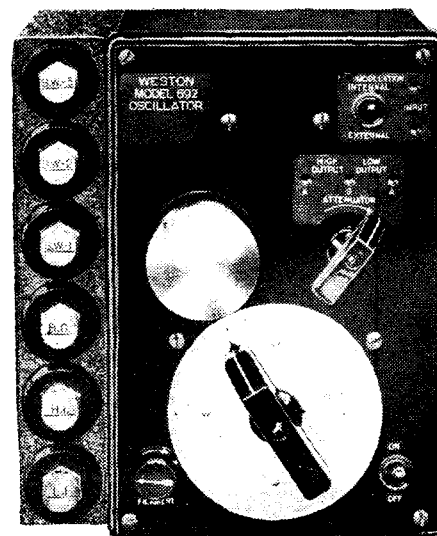

Weston modulated test oscillator.

New Components—

battery charging plant, whilst in the latter class there will be the Westinghouse models with some new additions, the

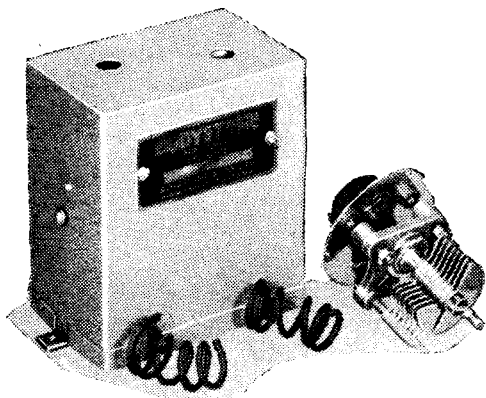

Some of the new Eddystone short-wave components; a 450 kc/s IF transformer and midget condenser.

Davenset series, Rotax units now to be shown by Crypto, and some small portable chargers by Burton, Heayberd and also by Sound Sales.

The service engineer will find his special needs well catered for this year. The Automatic Coil Winder Co. will have a new signal generator covering the ultra-short as well as the normal broadcast wavebands; internal modulation is provided by a separate valve, and a vernier-type dial enables small changes in the HF frequency to be effected with accuracy. There will be, in addition, the full current range of Avo meters and associated test gear.

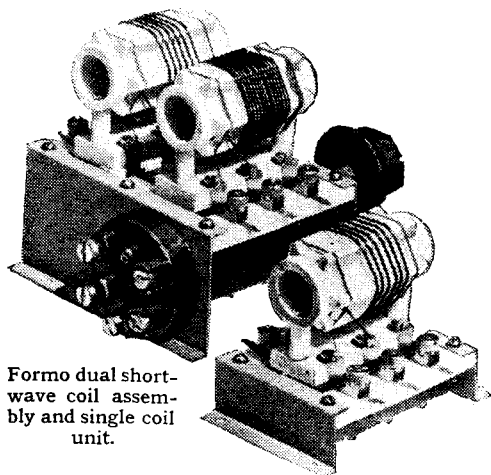

Formo dual short-wave coil assembly and single coil unit.

Many additions have been made to the series of test apparatus made by Wm. F. Brown, the most interesting of which is a mains-operated standard signal generator embodying a beat HF oscillator, a separately controlled modulator giving a 400-cycle note, amplifiers, attenuator and mains equipment. In all there are six separate units, each fully screened in brass boxes. Its frequency range is 1,500 to 100 kc/s. This firm will include also a short- and ultra-short wave oscillator covering 5 to 80 metres.

Haynes Radio has developed an AC-operated modulated oscillator with station calibration, and Wearite will show for the first time a new and complete series of test apparatus, including a modulated

oscillator, a calibrated frequency meter, primarily for the short waves, and which can be employed as an absorption wave-meter. It is fitted with plug-in coils and a small lamp indicator for checking transmitter frequencies. There will be multi-meter for AC and DC voltage and current measurements, also kindred apparatus. The Weston Electrical Instrument Co. will be showing a series of instruments, and Everett Edgcumbe have extended the Radiolab range and evolved a system of unit assembly that simplifies the handling as well as makes for easier portability.

In addition to showing several pieces of portable test apparatus Ferranti will have a full range of meters for AC and DC measurements. An inexpensive watt-meter and other measuring instruments will be shown by Bulgin.

Short-wave Components

The short-wave range, which for many years was the almost exclusive hunting-ground of the keen amateur experimenter,

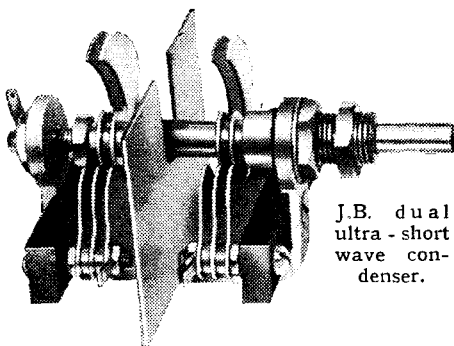

J.B. dual ultra-short wave condenser.

has now practically attained the status of a broadcast band; albeit it is still the only reliable channel through which Colonial listeners can keep in touch with the home country. Those manufacturers interested in this aspect of radio will be showing many new and improved components. The Eddystone exhibit will include a modified air-dielectric trimmer having an extended spindle, a new miniature reduction drive attachment and a flexible coupler that transmits the drive without undue friction through a wide angle. Stratton will show also an extensive range of Eddystone ultra-short wave components, special screening boxes, and the like.

Bulgin has evolved some new short- and ultra-short wave coils and valveholders, while Formo will have a two-coil assembly on a small chassis, including switches, the coil formers, and other essential parts being fashioned from Frequentite. The coils

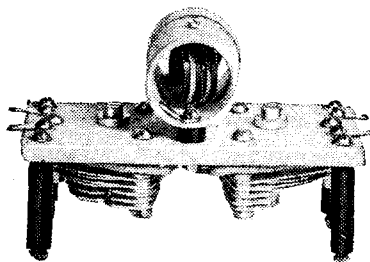

B.T.S. 12 Mc/s IF transformer for ultra-short wave superheterodynes.

are interchangeable. Both Colvern and Wearite have developed some new short-wave coils, and further models are to be shown by British Television Supplies.

This firm has developed and will show a 12-megacycle (25 metres) IF transformer

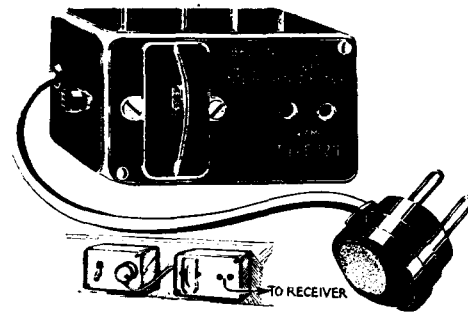

Belling-Lee radio power interference filter.

with air-dielectric trimmers and variable coupling for use in ultra-short wave superheterodynes. There will be a new single and dual short-wave condenser on the Polar stand, in which zinc-alloy vanes and insulated rotors are employed, while Clix and Belling-Lee will have some special low-loss valve holders. RI will be represented in this class by a series of short-wave converters, whilst the Eelex series will be shown by J. J. Eastick. Jackson Bros. will have some interesting ultra-short wave condensers in single and dual pattern.

Interference suppressors for practically every class of electrical apparatus will be a special feature on the Belling-Lee stand; T.C.C. are to show some examples, so will Bulgin and Graham Farish.

HT batteries, accumulator HT units and LT batteries in a variety of sizes, capacities and shapes will be very much in evidence, the battery set user being ex-

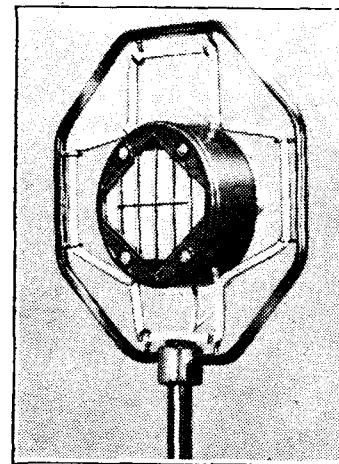

T.M.C. Varidep transverse current microphone embodying some new features.

tremely well catered for by such well-known firms as Britannia Batteries, Burndeft, C.A.V., Drydex and Exide, Ever-Ready, Fuller, G.E.C., Hellesens, Milnes, Oldham, Peto and Radford, Siemens and Vidor, among others.

Headphones constructed to the design of the famous S. G. Brown 'phones are to be shown by N.R.S., Ltd., in types A and F. Aids for the deaf will be featured

New Components—

by Ossicaide and Ardente, whilst microphones for use in public address work are to be included among the exhibits of Sono-

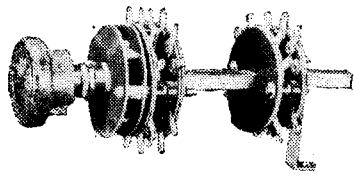

One of the new Bulgin switches.

chord, who have a piezo-electric model; T.M.C. with a new design transverse current type, the Varidep, and Epoch Reproducers, who will be showing a redesigned moving-coil microphone.

Switches will be a prominent feature on the Bulgin stand; several new models designed especially for short- and all-wave sets will be seen. Wearite are to show some models, so will Burton. Waterhouse will have a selection of well-made cabinets for housing receivers and batteries, also table stands in a variety of designs. Further examples of cabinets and table stands will be a feature of the Electrico exhibit.

GRAMOPHONE ACCESSORIES

MOST table-model receivers are equipped for the reproduction of gramophone records and the necessary auxiliary components will again be shown by those firms who have specialised in the manufacture of this type of apparatus in the past.

The Garrard stand will be devoted to a display of pick-ups, spring and electric turntable motors, radiogram conversion units, and, of course, the Garrard record-changer. A neat playing desk will be shown by Cosmocord, who have also a very complete range of pick-ups and motor units.

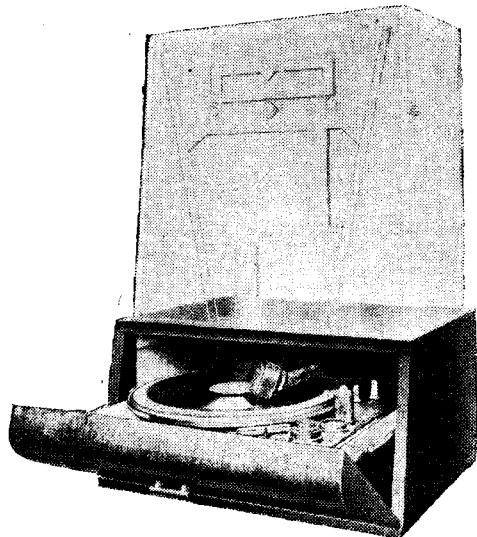

The Cosmocord playing desk is designed as a base for table-model receivers.

The piezo-electric pick-up will be an important feature of the exhibit of Sono-chord Reproducers, Ltd., and a new pick-up working on this principle will be found on the Ediswan stand.

Random Radiations

By "DIALLIST"

Radiolympia

WELL, here we are on the eve of another National Wireless Exhibition at Olympia. I hope that you will be able to attend, for there is no question that it's going to be the best show that we have had yet. Having attended every wireless exhibition since the first tiny affair, a long time ago now, I have no hesitation in saying that each year's show has been a big improvement on its predecessor. I don't mean only as regards the apparatus displayed on the stands; it is only natural to expect improvements in sets themselves and in the parts that go to make them up. Progress has been manifest also in what one may call showmanship. The decorations of the great halls and of the stands which they contain become more and more attractive and the "side-shows" more and more ambitious.

A Big Change

There has been, when you come to think of it, a big change in the nature of the exhibition during the past few years. It used to be staged chiefly for the technically minded; now, though the expert is fully catered for, the exhibition aims mainly at attracting the man in the street with his wife and family. This change reflects the progress that wireless has been making. Once a hobby for experts or budding experts only, it has now become part and parcel of the home life of all civilised countries. No skill is required to operate the home receiving set of to-day; any member of the family switches it on when he or she feels inclined and tunes in the desired transmission by the simple process of turning a knob until the pointer is opposite the name of the station.

Always Wider Fields

That is one side of wireless. Luckily, it has many others. Though it has become so far simplified that anyone can receive transmissions from a score of stations at will, it still offers, and probably always will offer, fresh fields full of interest to the experimenter. Countless problems still remain to be tackled, whilst new ones are ever cropping up. New ideas are always coming along, and trying them out gives full occupation for leisure hours. To mention but two which have been described in the *Wireless World* in recent weeks, automatic volume expansion and the new method of obtaining a large measure of high-frequency amplification upon the short waves must have provided hours of interest for experimenters. And what wonderful fields there are to explore in the short waves, the ultra-short waves, and television!

All-wave Sets

FOR a paragraph on the subject of all-wave sets which appeared in these notes some weeks ago I am taken to task by one of the engineers of the African Broadcasting Company. For some queer reason he appears to think that all-wave sets are quite

a novelty to me. They're not, for I used one of the first that made its appearance in this country. I must admit, though, that this kind of set was produced in America long before our makers began to turn them out. The reason is that, somehow or other, short-wave reception was a long time in achieving popularity with listeners in this country. There has always been a pretty large band of short-wave enthusiasts, but most of these preferred to make or to purchase special sets for their purposes rather than to combine the longer-wave receiver and the short-wave receiver into one. There are distinct signs now that interest in short-wave reception is widening, and I have no doubt that this year the all-wave receiver will be much more in demand with us than it has been in the past.

Requirements Abroad

My correspondent tells me that at least 80 per cent. of the receiving sets used in South Africa are of the all-wave type. This is natural, since on the medium and long waves the available alternative programmes there are comparatively few and far between. On the other hand, there is now a fine variety of short-wave services from all parts of the world. He mentions also one of the difficulties that British manufacturers have in competing for the African market. Nearly all sets designed for European use have a medium-wave range of roughly 200 to 550 metres. For South Africa the long waves are not required, but the medium-wave range must extend up to 580 metres. The Grahamstown station, for example, works on a wavelength of 560 metres. They have, further, to meet the competition of "dumped" foreign sets; and how serious this competition is will be realised when I mention that my correspondent tells me that 7-valve American sets have been sold off at £7 a piece. The only way for our people to catch up such markets is to produce something at a fair price which, in performance and reliability, is outstandingly superior to the dumped article.

**The B.B.C.'s Future**

IT should not be long now before Lord Ulliswater's Committee which is considering the future status of the B.B.C. makes its report public. There is no question that it will recommend a renewal of the B.B.C.'s charter for a further term of years, for the basis upon which broadcasting is organised in this country has proved most satisfactory. Naturally, there have been criticisms, and criticisms there will always be, but there is no shadow of doubt that we have by far the best programme service in the world to-day. Not the least of its good points are its detachment from both advertising and political propaganda. You have only to tune in stations in certain foreign countries to realise the evil effects of both these things upon the entertainment value of programmes.

It is to be hoped that the Committee will strongly recommend that a much larger proportion of the amounts received for licence fees is handed over to the Corporation. The amount at present paid to the B.B.C. is large, but it is nevertheless inadequate. Within a few months our high-definition television service will start, and it is most important that there shall be plenty of money available for this to be conducted on the best possible lines.

The All-Wave Set

The Important Features of Design

SHORT-WAVE broadcasting is rapidly becoming of importance and receivers capable of tuning over the medium and long wavebands in addition appeal most to the broadcast listener. The technical points which arise in the design of such sets are reviewed in this article, and it is shown that the problems involved, although capable of solution, are more difficult than one would at first suppose.

By W. T. COCKING

ALTHOUGH the requirements of the majority of listeners are amply met by the stations operating in the medium and long wavebands, there is an increasing interest in short-wave reception with a consequent demand for receivers capable of giving a high standard of performance over a much wider range of wavelengths than the conventional 200-2,000 metres. There are now many broadcasting stations operating on short wavelengths between some 13 metres and 80 metres, and it is by no means uncommon to obtain good results from American transmitters even during the daylight hours, while stations much farther away can often be well received. To the Empire listener, short waves are little short of a necessity, for he is likely to rely on them for his entertainment more than on the longer wavelengths; even so, his needs are not met by a purely short-wave set, for there are few countries in which some medium or long-wave transmissions cannot be received.

Not everyone will wish to employ entirely separate receivers for the different wavebands, although this can be regarded as technically the ideal course. To those who require more than medium- and long-wave reception, therefore, an all-wave set is a necessity, and a study of the problems involved will well repay us whether we wish to design a receiver of our own or to select a complete model.

We are so accustomed to receivers having two wave-ranges that at first sight it seems as if an all-wave set could be produced merely by the inclusion of extra coils for the new ranges and the fitting of additional contacts to the waverange switch. This is by no means the case, however, and an attempt

to convert a broadcast set for short-wave reception in this manner almost invariably meets with failure. The difficulties encountered in designing a set increase as the wavelength decreases for both dielectric losses and stray couplings assume much more serious proportions. The correct procedure, therefore, is to design the receiver for the shortest wavelengths and let the longer bands be the additions, rather than the reverse.

This cannot be done entirely, of course, and all ranges must be considered more or less together. This is well illustrated by the question of tuning. It is customary to cover the medium waveband in a single sweep of the tuning control, that is, a band of some 1,000 kc/s. With such a band, tuning is by no means critical, but it would become so if it were greatly increased unless the

than twenty-three ranges! In practice, it is rare for there to be more than three short-wave bands in addition to the two for the medium and long waves. The frequency range covered by a single sweep of the condenser is consequently much greater on the short waves than on the longer bands and the tuning is correspondingly more critical. If the set is to be easily tuned, therefore, a dial with a large reduction ratio is needed, and since this

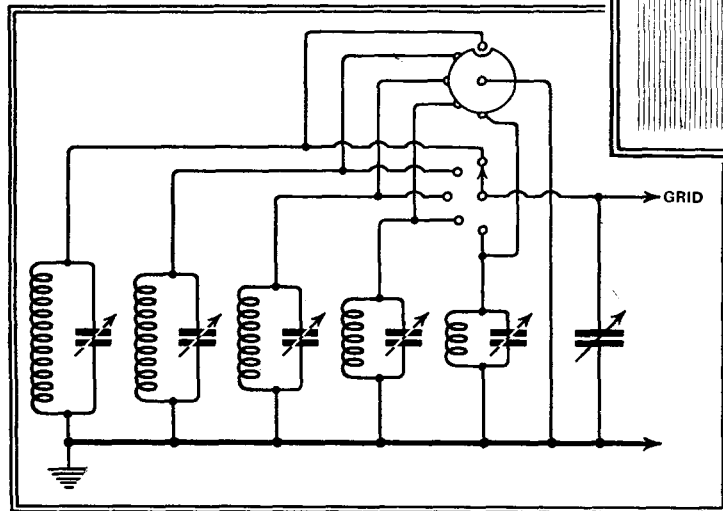
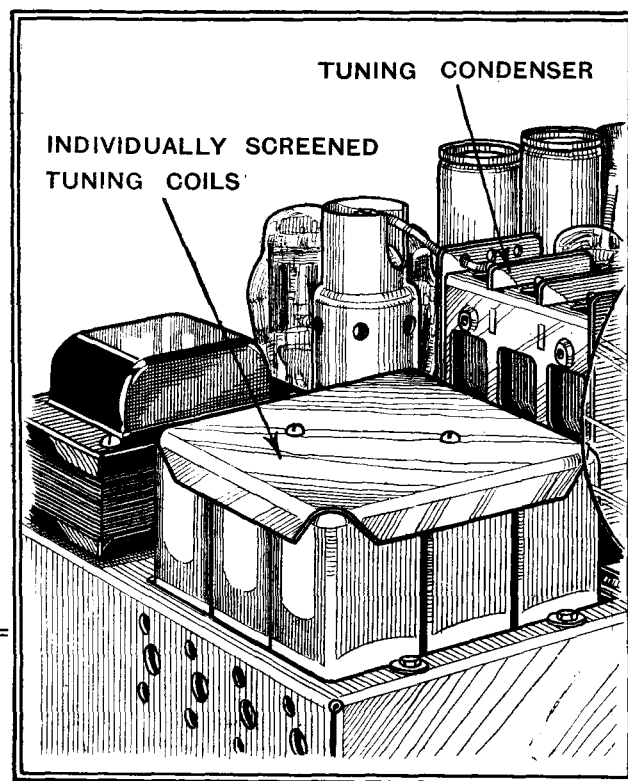

Fig. 1.—The ideal switching arrangements for one circuit of an all-wave receiver are shown here. The lower switch selects the desired coil and the upper short-circuits all others.

reduction ratio in the drive were correspondingly reduced. To cover the whole range of 13 to 2,000 metres in bands of this order, however, would mean no fewer



Individually screened coils are employed in this all-wave set in order to eliminate absorption spots.

is usually excessive for the normal broadcast bands, a dual ratio control is a very desirable fitting.

In order to cover the range on the longer wavelengths, the tuning condensers cannot have a much smaller capacity than 0.0005 mfd., and this is three to four times as large as is desirable for short waves. Although it is possible to reduce the maximum capacity by switching fixed condensers in series with it, the minimum capacity is hardly affected and places a very definite limit to the lowest wavelength to which it is possible to tune and retain any degree of efficiency. It is not unduly difficult to tune down to 15 metres using a standard gang condenser, but

The All-Wave Set—

great skill is usually necessary to obtain good results at shorter wavelengths. The difficulty is brought about by the fact that with a high minimum capacity the inductance used becomes almost vanishingly small and the tuned circuit is consequently inefficient. Besides this there is a limit to the possible reduction of inductance which is approached quite closely in short-wave receivers having a high minimum capacity.

In addition to the purely tuning problems, there are the questions of waveband switching and ganging. Ideally, a separate coil should be provided for each waveband and fitted with its own trimmer; each coil should be individually screened, and all the unused coils should be short-circuited. The switches should be of high insulation resistance, negligible contact resistance and of low capacity. This arrangement is shown in Fig. 1 for a single circuit on each waveband; transformer primaries and reaction coils, of course, require additional switches.

If the coils are not separately screened, those not in use may absorb energy from the one in circuit and so cause low sensitivity at certain points in the tuning range besides seriously affecting the ganging. Such screening is really a refinement, however, for if the coils be short-circuited they are unlikely to cause serious absorption effects. It is important to note, however, that if the coils are not short-circuited, individual screening is unlikely to be of any value, for they will be effectively coupled together by the capacity between the switch contacts and the leads to it.

Such capacities are, of course, very small, but their reactance is so low at the high frequencies involved that they can cause tight coupling between the different circuits. Stray capacities are, in fact, one of the major difficulties in short-wave receivers, for a capacity which will affect the performance to a negligible degree on the medium waveband may couple two circuits quite tightly on short waves. This is particularly noticeable in the frequency-changer, and it is difficult to avoid pulling between the signal and oscillator circuits without adopting extensive screening and isolating circuits.

The choice of intermediate frequency is another question of difficulty. A frequency of the order of 465 kc/s is desirable in the interests of selectivity on the medium and long wavebands. This can be used satisfactorily for short waves also, but the complete elimination of second-channel interference demands many pre-selector circuits. In view of the complicated switching and ganging arrangements needed for each circuit, it is not surprising that efforts are made to keep the pre-selection at its bare minimum and to reduce second-channel interference by using as high an intermediate frequency as can be tolerated from the point of view of adjacent channel selectivity.

When one considers the difficulties involved in the production of an all-wave receiver, the surprising part seems to be

that such sets work at all. They do work, however, and even a poor set will give results, although its performance will not approach that obtainable from one in which the important factors have received proper attention in design. All-wave receivers have been made for some time, but they are only now becoming at all com-

mon, and finality in design is still a long way off. Doubtless in a few years time the technique of such sets will be as firmly established as that of the broadcast-wave receivers of to-day. In the meantime, the development of all-wave receivers is a happy hunting ground for the serious designer and the experimenter alike.

Electrical Interference

Press Comments on Our Attitude

In a leader in the issue of the "Wireless World" of July 19th we reverted to the question of electrical interference with broadcast reception and deplored the unjustifiable delays which had taken place and the fact that obstacles to legislation were still accumulating. Below we publish interesting comments which appeared on our leader in the technical electrical press.

From the "Electrical Review" of July 26th.

THE all-mains receiving set is one of the best electrical missionaries, as has often enough been pointed out, but its value can be seriously depreciated by interference from other electrical apparatus. Moreover, the frequency band width has to be cut to about four kilocycles in order to secure good reception of a large number of stations. Manufacturers would be prepared to go to a much higher response figure, if this did not increase the liability to interference, thus enabling people with a sensitive ear for quality in music to enjoy foreign programmes. An I.E.E. Committee has been brooding over the subject for 2½ years, but with so little effect that the *Wireless World* suggests that the Postmaster-General would now be justified in seeking legal powers to control interference. The definition of "tolerable interference" is being considered by the International Electrotechnical Commission, but the precise degree appears to be of little importance in the large majority of cases. That something could be done now is evident from the far-sighted action of a few manufacturers of electrical appliances in designing these so as to cause no offence to the radio public. The electrical industry likes to assert its ability to put its own house in order, but too often it takes its own time about it. Meanwhile, the cost of remedying the conditions increases rapidly. Will this prove to be yet another case in which failure to submit agreed proposals will cause a plan to be imposed from outside?

From the "Electrician" of July 26th.

THE *Wireless World* of July 19th again draws attention to the position in regard to electrical interference with broadcasting reception. It urges that the representatives of the Post Office should resign from the I.E.E. Committee which has been sitting on the subject for 2½ years, so that the Postmaster-General may be free to introduce a simple Bill making unreasonable interference illegal and giving the Post Office authority to control it. The I.E.E. Committee has done some useful work, but, like most bodies so constituted, it is unlikely to produce the desired result in a reasonable time. Meanwhile we fear that this country is in danger of lagging behind the more progressive Continental States, which have taken definite powers to deal with the interference problem. With the coming of ultra-short-wave television the position will become still more acute than it is today, for every motor vehicle will then

become a potential source of annoyance. There is no hope that voluntary agreement, without any statutory obligation to suppress interference, will meet the needs of the case. The *Wireless World* indeed goes as far as to accuse the I.E.E. Committee of having done no more than "fight a very successful rearguard action against the public in defence of the electrical industry, which has been unwilling to admit any responsibility for interference and has resented the idea that it should be called upon to introduce remedial measures." While there may be some justification for criticism of the committee in question, this statement is altogether too sweeping.

Push-Button Tuning

THE radio-gramophone illustrated below was designed and constructed by a reader, Mr. F. G. H. Jeffs. It embodies a novel and extremely ambitious system of remote control; by means of a unit (seen on top of the set) installed at a distant point, any one of seven stations may be tuned in by pressing the appropriate button, and at

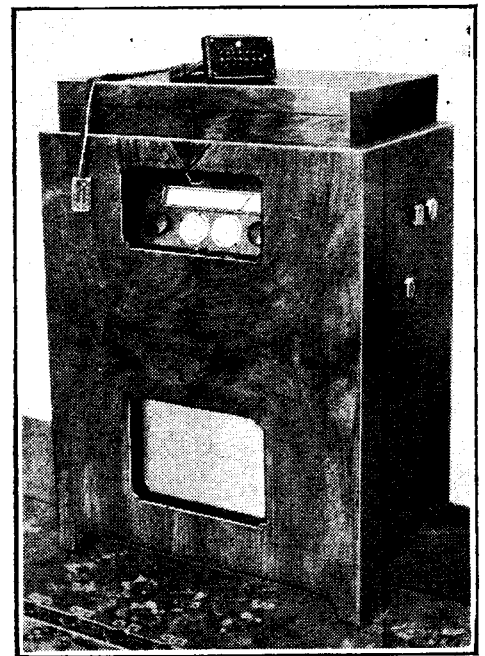

A home-made set with a complete remote control system.

the same time selectivity may be controlled to suit prevailing conditions by buttons marked either "20 kc/s" or "5 kc/s." Change-over from radio reception to gramophone reproduction is similarly effected from the distant control point, whence volume can also be regulated. In addition, the tuning condenser may also be rotated in such a way that any station other than one of the pre-selected seven is tuned in at will.

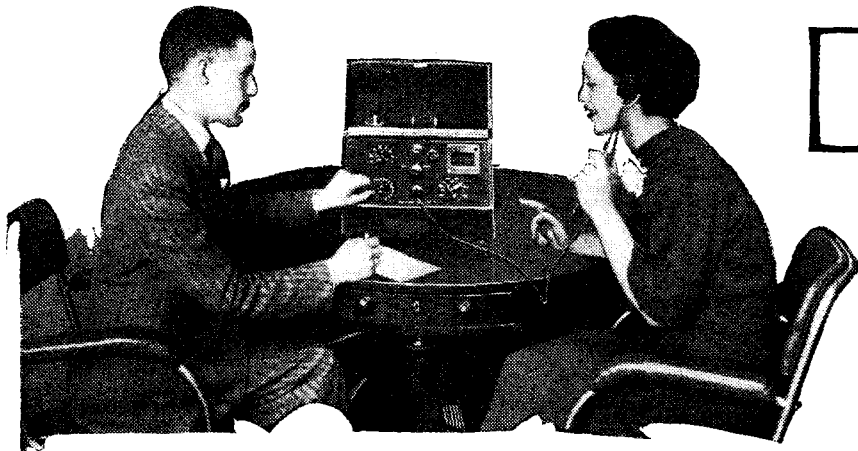

The Radio-Aid audiometer in use.

Deaf-Aids

Their Purpose and Performance

By N. W. McLACHLAN, D.Sc.

THE time will soon come when foolish prejudices against the use of hearing aids will be overcome, just as happened in the case of optical aids, which were once regarded as a handicap to those who resorted to them. This article gives some idea of the progress which has been made in the scientific design of deaf-aids, and indicates how remarkably efficient they can be when properly used.

A DECADE or two ago persons who wore spectacles were frequently regarded as being inclined in the direction of femininity. Objections were raised that such persons could not perform certain functions properly in everyday business life, and candidates for various jobs were promptly ruled out if their optical systems had to be assisted by external means. This prejudice against optical aids has now disappeared, and there are few employers who take any notice of the optical propensities of their staffs except in special cases. The collapse of the barriers—purely fictitious and existing in the interstices of curious cerebrations—against optical aids has brought to light the fact that an appreciable percentage of the population of all civilised countries ought to use such appliances. At the moment we are passing through the throes of a somewhat similar situation regarding deaf-aids. Many deaf people are sceptical of them because they are bulky, and in some cases the aids have not been adapted to the individual, whilst there has also been a lack of scientific design and testing.

Deaf-Aid Must Suit Individual

Everyone knows that father's spectacles won't suit young Richard or Aunt Maria, and in just the same way any old deaf-aid is not suitable for ten different persons chosen at random, unless, of course, the law of probability fails to work! Those whose business it is to prescribe or to supply deaf-aids express the view that there is almost as large a proportion of people who need assistance for their hearing as with their sight. Admittedly, the general run of satisfactory deaf-aids are more costly and less elegant to wear than a mere pair of spectacles, but a properly designed aid confers advantages out of all proportion to any disadvantages which can be levelled against its use.

To understand the problem of prescribing a deaf-aid for a patient, it is neces-

sary to know something of the characteristics of the normal human ear under ideal conditions. Since the advent of the thermionic valve, and as a result of the intensive study of acoustical matters during the past decade, the organ of hearing has been the subject of much profitable research. By virtue of the information now available it is possible to supply a deaf-aid which is suited to the particular patient.

In making scientific tests on the normal ear the subject is seated in a room which

setting of an attenuator used to control the value of the 'phone current until it reaches a point where the sound is just audible, this being made known by visual signals on a lamp connected to a push button near the subject.

Since the apparatus is calibrated beforehand the sound pressure in the ear canal is obtained from the attenuator setting and a note made of it. This procedure is repeated at higher frequencies up to about 20,000 c/s. A number of other subjects with normal hearing are tested and the average reading at any frequency is taken as the lower threshold of audibility corresponding thereto. In general, the tests are conducted with persons whose ages vary from 18 to 30 years. The test is then followed by one where each pure tone is made loud enough for the subject to "feel" the sound, so to speak. The feeling, or pain, stage is usually preceded by a fluttering or tickling sensation. The two curves drawn in Fig. 1 and marked threshold of hearing and threshold of feeling respectively were obtained in this way. Incidentally, it may be appropriate to remark that the threshold of feeling is practically the same for all persons whether they are deaf or have normal hearing. The thresholds of hearing and feeling are coincident at the extreme ends of the audible range, and, as shown in Fig. 1, they enclose an area known as the auditory sensation area for the normal ear.

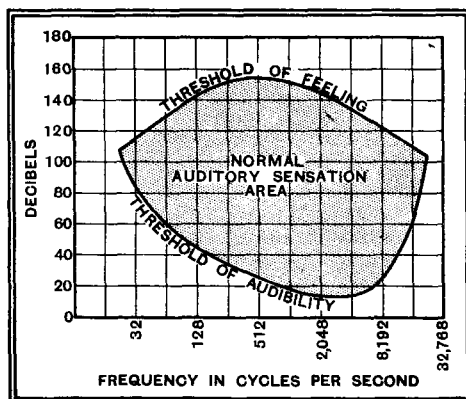

Fig. 1. Diagram showing thresholds of audibility and feeling for normal ears.

is made acoustically "dead" by using absorbent material on all its inner surfaces. The acoustical condition in the room simulates that in free-air where there is no external noise. The only noise in the dead room will be that due to the subject himself, caused by heart-beats, breathing, coughing, sniffing and what not! A telephone earpiece is fixed over one ear by a head band (*vide* pictures of the G.P.O. telephone belles) and an operator outside the padded room closes a switch, thereby connecting a supply of pure alternating current to the telephone earpiece. It is usual to commence with a low frequency, so we can assume that a current of 20 cycles per second is supplied to the telephone so as to be audible to the subject under test. The operator then alters the

Explaining Threshold of Audibility

Since the threshold of audibility of a normal person is given by the lower curve in Fig. 1, if the above test is carried out on a deaf person his threshold of hearing can be ascertained. Suppose that this has been done, and that the result of the test is indicated by the dotted line in Fig. 2. Then the difference between the two curves expressed in decibels, is a measure of the deafness of the person in question. The shape of the lower threshold curve will not be the same in every case, since it varies from person to

Deaf-Aids—

person. Consider, for example, the dotted threshold curve in Fig. 3. The patient is deaf to frequencies from about 50 to 1,500 cycles per sec., but above the latter frequency his hearing is normal. This type of deafness would be diagnosed by an

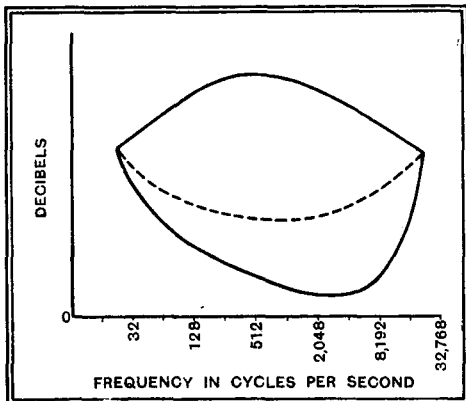

Fig. 2. The dotted line shows the threshold of audibility of a person who is equally deaf over the frequency range.

acoustical engineer as low-frequency deafness. He would probably fail to hear the drums and double bass of the orchestra, so that putting a baffle on his loud speaker would be merely superfluous. In like manner people may be deaf to high but not to low frequencies, this being the more common complaint of the two. Here a speaker with prolific resonances above 2,000 c/s would not be disagreeable.

It is hardly necessary to say that it would be very costly and inconvenient to test a patient's hearing by means of the elaborate apparatus used to determine the lower threshold curve of Fig. 1. Consequently, portable apparatus has been devised whereby the threshold of audibility of any person can be compared with that given in the lower curve of Fig. 1, in an ordinary room where the level of extraneous sounds is low enough not to interfere with the tests. The instrument used for this purpose is called an audiometer, and the curve is called an audiogram.

An audiometer contains a valve oscillator which can be adjusted to give a number of frequencies (pure tones). In the Western Electric 2B audiometer of Fig. 4,

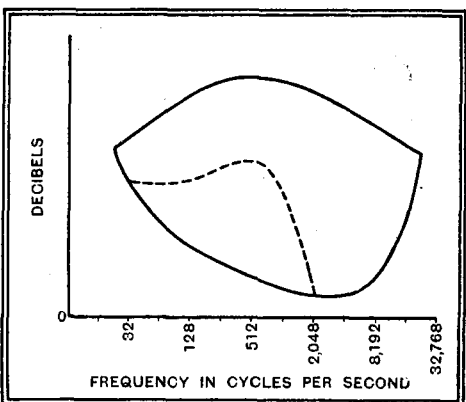

Fig. 3. The dotted line shows the threshold of audibility of a person who is deaf to low tones.

which is worked off the electric supply mains, there are eight octave steps which cover the range 64 to 8,192 c/s, i.e., 64, 128, 256 c/s, etc., whilst in the audiometer of Radio-Aid, Ltd., seen in use in the title illustration, the range extends in eleven half-octave steps from 125 to 4,000 c/s. There is an attenuator in each instrument whereby the oscillator output to a telephone earpiece can be controlled over a very wide range. The earpiece is used by the patient in the usual way.

The 2B audiometer has a signal lamp which is operated by a push-button switch so that the patient can indicate silently when the test tone is audible. It also has a switch for cutting out the oscillator so that the accuracy and good faith of the patient can be checked. In making tests with either type of audiometer the lowest tone is sounded in the telephone earpiece at an audible intensity. Upon hearing this tone the patient either presses a button which causes the signalling lamp to light, or he signals to the operator in any other

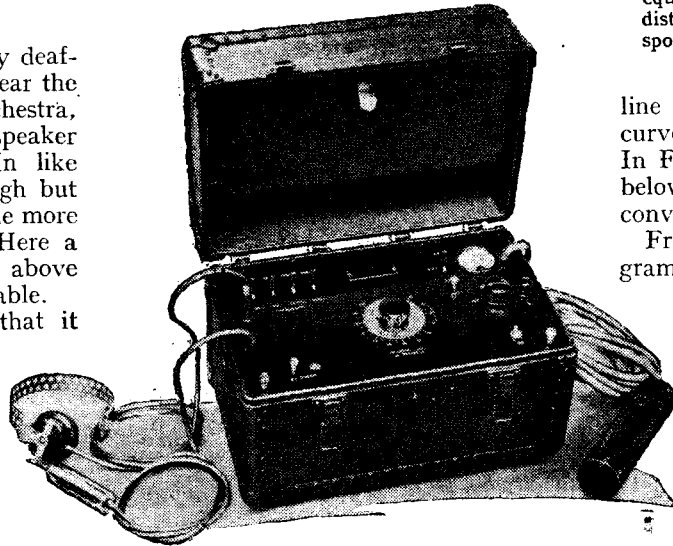

Fig. 4. The Western Electric 2B audiometer which is energised from the electric supply mains.

convenient manner. The attenuator is then turned slowly towards its zero position until the tone is just audible. The patient makes this fact known. The same procedure is followed at intervals up to the highest test frequency of the audiometer, and the attenuator readings are plotted on a chart as illustrated in Fig. 5. The horizontal line marked normal hearing corresponds to zero on the attenuator at all test frequencies. The corresponding output from the telephone earpiece is not zero, however, since it is adjusted to give that sound pressure in the ear canal which occurs at the threshold of audibility as obtained from the lower curve of Fig. 1.

When the attenuator reading is increased, it means that the level of the tone in the receiver has to be raised in order to reach the lower threshold of the patient. Thus the attenuator reading gives the threshold shift of the patient in decibels, due to his deafness at various frequencies. For example, suppose that the attenuator reading is 30 db. at 8,192 c/s, then the patient's threshold of

audibility is 30 db. above that of a person with normal hearing. Thus 1,000 times more sound power is required to give audibility for the deaf person than for a person with normal hearing. The dotted line in Fig. 5 represents the threshold of feeling. The distance between it and the horizontal

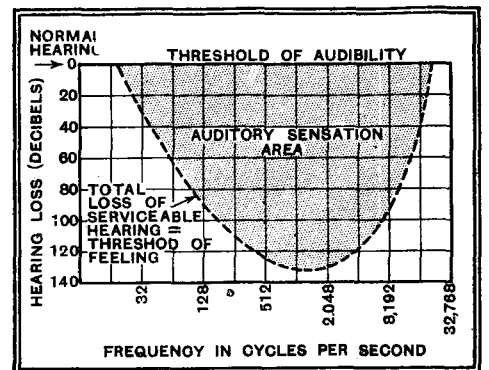

Fig. 5. Showing Fig. 1 plotted in a different manner which is suited to plotting measurements on deafness. The shaded areas are equal in both cases, as also are the vertical distances between the curves at the corresponding frequencies. Audiograms are always given in this form.

line is equal to that between the two curves of Fig. 1 at the same frequency. In Fig. 5 the upper threshold is plotted below the lower threshold line, which for convenience is taken to be horizontal.

From the shape of the patient's audiogram it is usually possible to diagnose his trouble and prescribe for it accordingly. In the Radio-Aid type of audiometer the prescription can be checked *in situ*. The audiometer is fitted with a microphone and a valve amplifier leading to a telephone earpiece. By means of a selector switch filters are introduced whereby the characteristic curve of the amplifier can be modified in seven different ways. For instance, either the high or the low frequencies can be accentuated. Reverting to Fig. 2, this shows the lower threshold curve of a person who is uniformly deaf in one ear over the range of test frequencies. Obviously, he requires a deaf-aid which amplifies uniformly over the frequency range. The audiometer is set

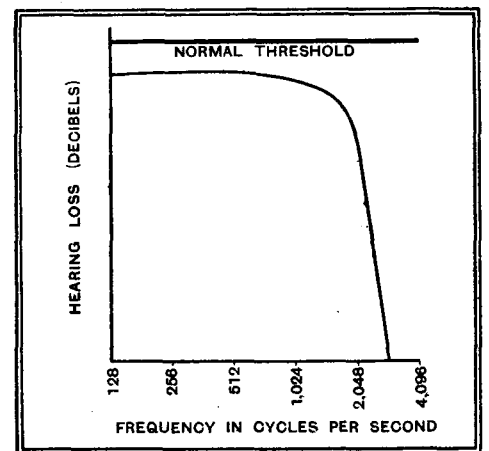

Fig. 6. Audiogram of person deaf to frequencies above 2,000 c/s.

Deaf-Aids—

accordingly and the prescription tested there and then to the satisfaction of the patient. Fig. 6 illustrates an audiogram of a person who is deaf to frequencies above 2,000. The appropriate deaf-aid must, therefore, have a valve amplifier,

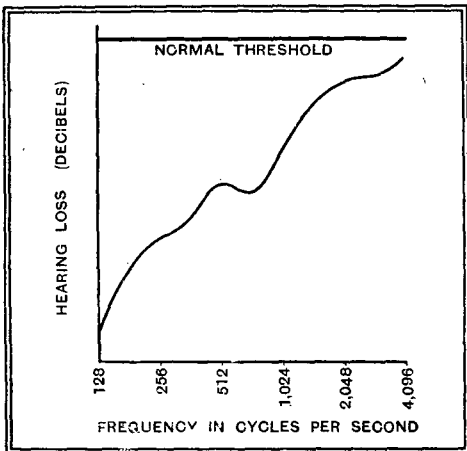

Fig. 7. Audiogram of person deaf to low frequencies.

the characteristics of which rises above 1,000, and this prescription can be checked by moving the selector switch of the audiometer to the appropriate stud. Fig. 7 is an audiogram of a person suffering from deafness to low frequencies. This complaint may be caused by otosclerosis where the ossicles (see Fig. 9) have become severely restricted in their movements.

Forms of deafness.

As readers are aware, the amplitude of a loud speaker diaphragm for a given sound output is greatest at low frequencies. This also applies to the ear drum and its associated mechanism, so that if the low-frequency amplitude is restricted the hearing of low tones is impaired. Fig. 8 may be of some interest as it represents the audiogram of an extremely deaf person. The cause of the trouble is probably severe catarrh. In the case of persons whose hearing loss is too great to be recorded by the audiometer, but who are not stone deaf, no amplifier should be used since the output required to give adequate hearing may cause damage to the ear.

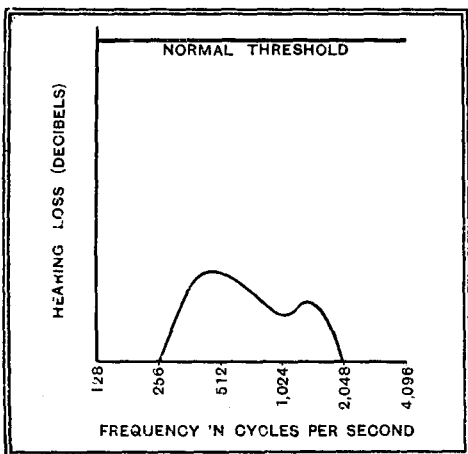

Fig. 8. Audiogram of very deaf person.

There are various forms of deaf-aid. The Western Electric supply an aid comprising a special type of carbon microphone which has a good frequency characteristic, with a microphone type amplifier if desired, coupled to a telephone earpiece *via* a volume control (see Fig. 10). This aid is operated by a pocket battery and is quite light in weight. Radio-Aid, Ltd., specialise in the valve amplifier type of instrument. The user can sling it over his back like a pair of field glasses so that life might be imagined to be a succession of glamorous Derby days! This model is illustrated in Fig. 11. The wearable model consists of a special microphone transformer coupled to an amplifying valve, this in turn being resistance-coupled to a bank of three small-power valves in parallel. There is, of course, a control for adjusting the output from the telephone earpiece.

We now come to deaf-aids for use in churches and schools. For churches the equipment comprises (1) a microphone placed on the pulpit rail, (2) a valve amplifier operated either from batteries or direct from the electric mains, and (3)

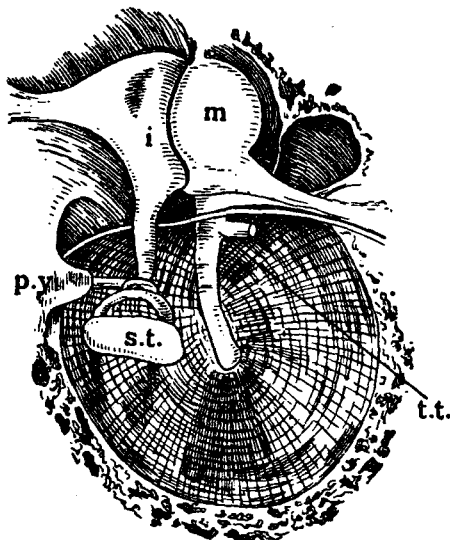

Fig. 9. The ossicles and ear-drum as seen from within. m = hammer, with its lower part attached to the ear-drum; i = anvil; st. = stirrup (after Schüfer). (From *Hearing in Man and Animals*. By R. T. Beatty).

listening points situated in the pews where deaf members of the congregation sit. The microphone is small, being 2½ in. x 2½ in. x 1 in. deep. Special technique is not necessary on the preacher's part. Each listening point is equipped with a telephone earpiece mounted on a lorgnette handle and connected by a flexible cord to a volume control on the book-board in front of the user.

So far as deaf children are concerned (called deaf and dumb, deaf mutes, etc.), it is found that many of them have more measurable hearing than very deaf adults. The latter, however, owing to their previous experience of sound, can carry on a conversation without lip reading, either

by using a deaf-aid or by the crude process of being shouted at. This is said to be due to their so-called "compensation," which is a mental readjustment enabling them

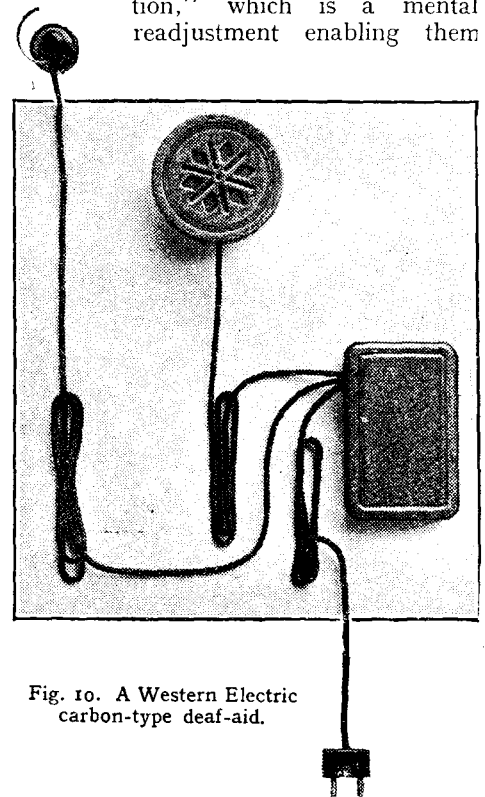

Fig. 10. A Western Electric carbon-type deaf-aid.

to guess words which are distorted by virtue of their particular form of deafness. Children in schools for the deaf are taught to speak. Since they have no prior experience of sound, amplified and tone-corrected speech which is intelligible to a deaf adult will not be understood by a deaf child without the necessary tuition. A deaf-aid for children ought to be as free from distortion as possible. This means that the microphone characteristic should be free from resonance peaks and frequency doubling. Any boosting of high or of low frequencies can be effected in the valve amplifier.

Apparatus for use in schools is shown photographically in Fig. 12, and is manu-

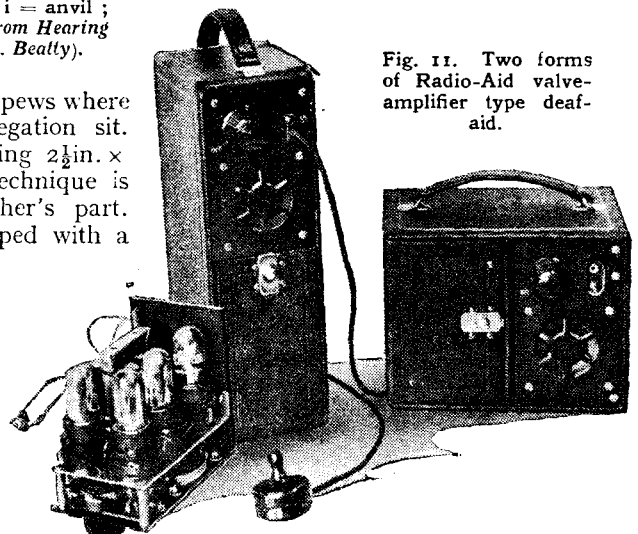

Fig. 11. Two forms of Radio-Aid valve-amplifier type deaf-aid.

factured by Multitone Electric Co. It is a combination of a radio set and a deaf-aid, and can be switched from one to the other by turning a knob. For deaf-aid

Deaf-Aids—

purposes the moving coil speaker is worked backwards and used as a micro-

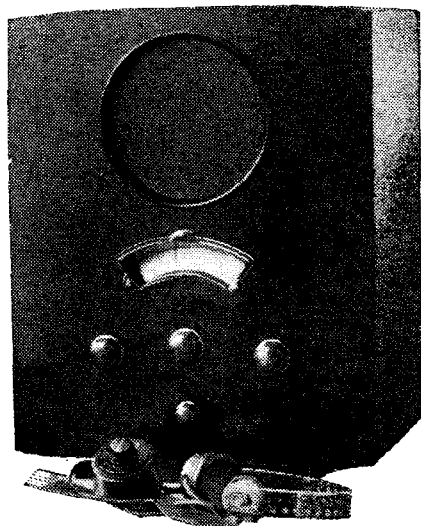

Fig. 12. Multitone Electric deaf-aid apparatus for use in schools.

phone. The voltage generated by the moving coil vibrating in the magnetic field is amplified by several valves and the

output taken to a multi-point distributor of the type illustrated in Fig. 13. Each point is fitted with a correction control and a volume control, and it is connected to a telephone earpiece worn on the head with a band. We have already indicated that the degree and kind of deafness de-

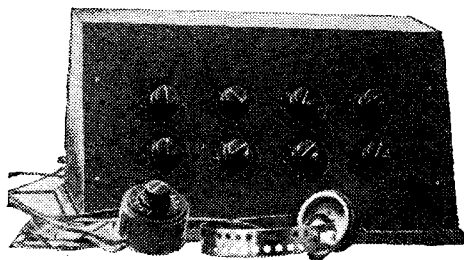

Fig. 13. Multitone Electric distributor unit for use in schools.

pends upon the individual. If there are twelve deaf children, no two of their deafness characteristics may be alike. Thus it is necessary to make provision for modifying the frequency characteristic of the input to the telephone receiver to suit individual requirements. When used for wireless reception for the deaf the input

from the radio takes the place of that from the microphone. The instrument can also be used to obtain broadcasting programmes from the speaker in the

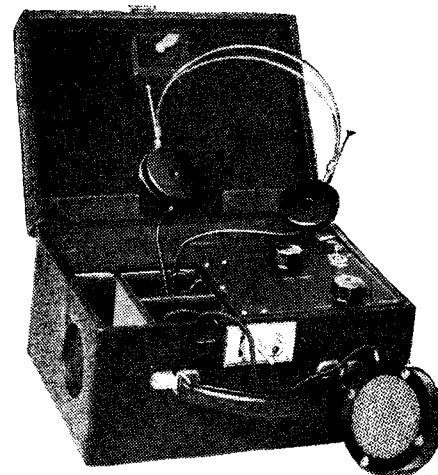

Fig. 14. Multitone Electric portable valve-type deaf-aid.

normal way. By means of a filter in the apparatus it can be used to determine whether the patient's hearing is deficient in general or merely in high or low tones.

Letters to the Editor

The Editor does not hold himself responsible for the opinions of his correspondents

Battery Sets

A RELATIVE of mine who lives in the country, and whose principal source of relaxation and entertainment is listening to foreign broadcast programmes, has no electric main supply, and is compelled to rely on a battery receiver. He has, however, a domestic lighting set (50V), whereby he can keep his HT accumulators in good condition, charging in parallel and discharging in series. Economy in current is of very little consequence, but first-class quality on distant reception, which is not ordinarily attainable with existing battery receivers, is a prime consideration. A design for a battery set in which the quality of reception was kept at the highest possible level, regardless of battery consumption, would be a real boon in his case, and there must be many others where, for one reason or another, similar conditions apply.

I hope to see you publish such a design in the none-too-distant future.

Hampton Hill, J. E. SEARS.

Modulated Test Oscillator

CURIOSLY enough I have tried the refinement suggested by Mr. R. E. Blakey on the W.W. specified oscillator. My conclusion is that the attenuator and coupling to various sets under test alters the calibration rather more than a change in voltage supply. On the whole, I prefer the oscillator as originally described with a rather larger battery and maximum attenuation. Not liking the particular cabinet over much, I have housed my own oscillator in a copper box with a sliding lid—rather larger than your dimensions to allow for experiment. I would suggest as a detail that the ranges could be described

I, II, III, IV, starting with the *lowest* f. range, and the switch worked clockwise in that order—one is thus "going up" the whole time.

The coil makers are to be congratulated on a very nice job at a reasonable price. Practically speaking, your published curves are so near my results as to make it hardly worth while to draw others. Changing the range down brings in an harmonic in nearly every case without altering the dial.

Few of us will be content until we have a first-grade instrument, but in the meantime I can strongly recommend readers to make the W.W. Modulated Test Oscillator as being quite up to the commercial standard.

WARE, HERTS.

GERALD SAYERS.

Output Valves

IT is of primary importance that a standard of comparison be available in development work. As regards power output valves, the Class A triode has hitherto been taken as such a standard for evaluating pentodes and other newer types of valve as regards distortion levels. It is easy to measure distortion physically, but it is hard to determine what kind and degree is audibly unobjectionable. The triode used as above is still, as far as I know, unsurpassed for linearity, and its measured physical distortion may be taken as a valuable standard of audibly unobjectionable distortion.

In Mr. M. G. Scroggie's article entitled "New Output Valve," in your issue for July 5th last, the second paragraph seems likely to mislead, and, to that extent, to hinder proper evaluation of new results. The best part of the triode's characteristics is

not that covered by positive grid voltages, except, indeed, as concerns power output without regard to distortion. The linearity is lost at positive grid voltages.

A convincing measure of distortion is to plot the mutual conductance along the length of the working load line itself as a function of the input grid volts. If this is done the Class A triode is found to depart little, indeed, from perfect linearity for loads which are not too low. If a triode is measured at positive grid voltages the linearity—or, rather, the lack of it—becomes as poor as that of a pentode. A pentode, as Mr. Scroggie rightly observes, gives admittedly poorer quality of reproduction. The reason for the loss of linearity at positive grid voltages has nothing to do with the non-linear flow of grid current, though if this is not made negligible in effect, or cancelled out as in the 6B5, it will add to the distortion. It is because positive grid anode characteristics are of the "saturated" type, i.e., they have a knee, to the right of which is the working area. This would not, itself, necessarily mean distortion if the characteristics were straight in the working area. Unfortunately they are not. The knee is not sharp and continues to add curvature to the anode characteristics up to the working anode voltage. This is just what occurs with a pentode also, and in typical cases (with positive drive triodes, pentodes, and with the valve Mr. Scroggie describes) the result is a drop of about a half in the mutual conductance at both ends of the optimum load line. With a Class A negative drive triode the drop only occurs at the negative end of the load line, and only there to a small extent at working loads.

This letter is a plea for the preservation of a valuable standard of comparison. It is not, by the way, a criticism of the merits for a given purpose of any particular kind of valve, which is a subject far too complex for the space available.

J. H. OWEN HARRIES.
Frinton-on-Sea.

MODERN VALVES

From the Laboratories : New Midgets—Multiples—Specials

DEVELOPMENT in wireless valves has made such vast strides during recent years that one might be pardoned for thinking that finality has now been reached. No such thing; new valves still issue from the valve laboratories, and although the additions this year are fewer in number, there is little sign of an abatement in the flow of new types. The frequency-changer is a very important part of the superheterodyne, and the new valves at last year's Olympia Exhibition were very largely the now familiar heptodes, octodes and triode-pentodes designed for use in this stage. Few new frequency-changers will be found this year, although Mullard have added a battery model octode to their range.

The triode-hexode has made its appearance in the Marconi and Osram ranges, however, and is available with a 4-volts heater, the X41, for AC sets, and with a 13-volts heater, the X31, for universal operation. It consists essentially of a hexode mixing valve and a triode oscillator built into a single bulb and with electronic coupling between the two. A tuned anode

Every valve maker will have Universal valves on view, most specimens requiring 13 volts for the heaters. There is still a divergency in the heater currents taken by different makes, the Ferranti, Marconi and Osram taking 0.3 ampere, while the Cossor, Mazda and Mullard consume 0.2 ampere. The Cossor series is now complete and includes an output triode with a mutual conductance of 7.5 mA/V. It is the type 402P and is rated for 8 watts anode dissipation and a 40-volts heater supply. The Mazda range now includes the PenDD4020, a 40-volts 0.2 ampere duo-diode-output pentode rated for 250 volts on both anode and space-charge grid. It has an output of over three watts and acts also as a detector and AVC source.

The well-known Mullard HF pentodes of the AC type are still made, but are also available with the control grid brought out to the top of the bulb instead of the anode. The valves of this type bear the subscript B to their type numbers.

Many new valves will be shown by Hivac, including midget types of battery valve with 2-volts 0.06 ampere filaments. There are two triodes and a screen-grid valve in the range, and they are ideal for use in deaf aids and portable equipment where space is at a premium. They will also be available fitted with Frequentite bases for use on short waves. The V220 and ACV volume expansion valves will also be on view; these are double-triodes for push-pull operation with variable-mu characteristics. There will also be the Harries output valve—a tetrode which is claimed to have better characteristics than a pentode. The negative resistance kink of the ordinary tetrode is avoided in this valve by critically spacing the anode from the other electrodes.

Special Types

Although receiving valves will form the major portion of the exhibit of most firms, special types will not be lacking, and the Osram A537 is of particular interest. This is a triode specially designed for silent operation. It is intended chiefly for use in the pre-amplifier for a condenser microphone, and although it is indirectly heated it is recommended that its heater be operated from a DC source. It is a triode of small dimensions with an AC resistance of 10,000 ohms and a mutual conductance of 1.5 mA/V. The usual pins in the base are absent, the grid is brought out at the top of the bulb, and Steatite insulation is employed. Counterparts of the well-known ML4 and MH4 valves are also available with Steatite insulation and top-grid connections under the type numbers of ML40 and MH40, and these also are intended for use in microphone amplifiers. These three

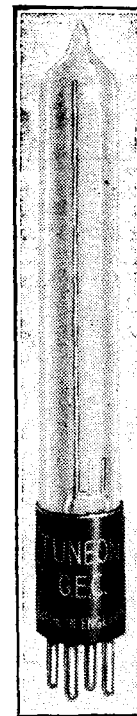

(Left) The Cossor 210VPT battery variable-mu pentode, and (right) the Tuneon tuning indicator.

valves are all listed at the same price of 50s.

The PT25H pentode of the same firm has been modified for transmitting purposes. As the DET8 it is hard-pumped, and so is suitable for use as an oscillator, and the suppressor grid is brought out to a separate terminal so that it is possible to employ suppressor grid modulation. A new output valve, the DA30, will also be shown. This is similar to the PX25A, but is designed for a 500-volts anode supply. Used in the "low-loading" circuit, a pair of these valves will give an output of 45 watts. In addition this firm will also be showing the Tuneon—a tuning indicator of the neon type.

In addition to the new types every firm will be showing its well-established models, and many examples of almost every conceivable type of valve will be found. Diode detectors and rectifiers, triode amplifiers, tetrodes, pentodes, heptodes and octodes, in battery, AC and Universal types will be there in plenty, with multiple valves of the DDT, DD HF pentode, and DD output pentode class, triode-hexode and triode-pentode frequency-changers, as well as double-triodes and double-pentodes for QPP, Class B, and volume expansion.

Although not valves in the accepted sense of the word, the Westinghouse metal rectifiers are conveniently classed under this heading. A wide variety of types will be shown, from the low voltage high-current types for battery chargers to the high-voltage models for HT supply apparatus, while very low-current types for high-voltage supplies in cathode-ray gear will be on view. In addition, the well-known Westectors should not be overlooked.

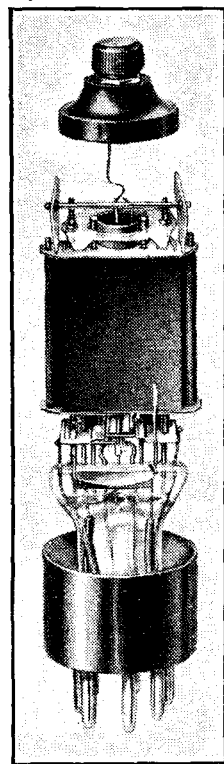

The Osram A537 special "noiseless" triode for microphone amplifiers is fitted with a top-cap for the grid connection. Steatite insulation is used.



(Left) The Mazda Pen DD 4020 duo-diode-output pentode for universal operation, has a 40-volts heater.

oscillator circuit is recommended and the oscillator voltage should be about 10 volts. The valve is claimed to have special advantages in short-wave reception and to be suitable for operation in the ultra-short waveband, giving greater freedom from pulling than other systems. The conversion conductance is about 550 μ A/V. The AC resistance is very high.

BROADCAST

By Our Special

Correspondent

BREVITIES

Another B.B.C. Dance Band

AMONG the many phenomena this autumn which will be-taken the vast changes taking place at Broadcasting House will be the appearance of another B.B.C. dance orchestra. Henry Hall's forthcoming visit to America is intimately connected with this new move. He intends to investigate those "bigger and better bands" on the other side.

Jazz Princes Waiting

Actually, Mr. Hall will spend only a week on American soil; the other two weeks of his "holiday" will be consumed in travelling. He will make the most of the seven days, however, having already received effusive greetings from some of America's best known band leaders, and no doubt a galaxy of genial jazz princes will welcome him on the gangway. The rest will be plain sailing.

Playing in Sections

The new band will form a section of an enlarged B.B.C. dance orchestra, the present band comprising Section A, and the newcomer Section B. The two units will sometimes play together and sometimes separately in the same manner as the sections of the B.B.C. Symphony Orchestra.

Henry Hall Not on B.B.C. Staff

Recent talk about the appointment of a dance band director is not entirely off the mark. On October 1st all dance bands that broadcast will come under the eye of the Variety Department, or, in other words, Mr. Maschwitz.

This does not, of course, imply that Henry Hall will be on the Variety Director's staff; contrary to common assumption, Henry Hall, unlike his band, is not on the staff of the B.B.C. He comes under the "Artists" heading, his service with the B.B.C. being by contract.

Daring Speculation

Couple this reflection with the probability that the B.B.C.'s new dance band director, if and when appointed, will be an expert dance musician, and we have material for daring speculation.

Sharman's Shows

ALL the palpitating anxieties lest the season of seaside jollity should rob Radiolympia of the choicest stars in the broad-

casting firmament have been dispelled by that five-and-a-half feet of live wire—John Sharman. The shows at Radiolympia will be partly devised by him and staged by him. He is being called the Barnum of broadcasting.

Bill of Fare

Rushing hither and thither, he has brought together such a collection of microphone favourites that it would certainly not be safe, in case of earthquake or explosion, for all of them to be in the R.M.A. Theatre at the same time.

The list, from which a daily choice will be made, now includes Elsie and Doris Waters, Anona Winn, Collinson and Dean, Harold Ramsay, The Radio Three, Stanelli, Leonard

Autographs

Talking of mobbing artists reminds me that the performers who leave Broadcasting House on foot these days are lucky if they can pass the steps of All Souls' Church unmolested.

Now that the school vacation is in full swing small boys sit on the steps with autograph albums and pencils at the alert. Every person of imposing looks who leaves the B.B.C. headquarters is asked to sign. Fortunately, the boys are often deceived by appearances.

I was not asked to sign.

Gerald Cock is Thinking

GERALD COCK'S last job as "O.B." director was the Tidworth Tattoo, broadcast on



GETTING DOWN TO IT. The Côte d'Azur broadcasting station at Nice is not content to relay seaside concert parties. Reporters take the microphone down to the beach and have chats with the swimmers and sun bathers. The station aerial can be seen in the background in the above photograph.

Henry, Jenny Howard and Percy King, Parry Jones—the famous tenor—and Geraldo and his Gaucho Tango Orchestra, to name only a half of the artists who will appear in person

Handle with Care

A special notice will be prominently displayed in the hall: "Don't mob the artists," which I regard as a direct incitement to do so, just as the old lumber-camp injunction: "Don't shoot the pianist—he is doing his best" always sent the hands of the audience to their hip pockets.

Saturday last. Now he is handing over to Mr. S. J. de Lotbinière, and is free to consider the hundred-and-one questions affecting television.

I hear that Mr. Cock is literally engaged in silent contemplation. The organisation of television bristles with problems of policy. Such questions as the B.B.C.'s attitude to the film industry, the place which television must fill in relation to all the other activities of the Corporation, sources of programme material, expense, etc., must all be courageously faced at the outset.

No Television Before Easter?

In the meantime, big changes are taking place at Alexandra Palace, and among them is the conversion of the small theatre there into a television studio.

Despite this feverish activity, however, it is being suggested at Broadcasting House that the first regular television programmes need not be expected before next Easter.

Under-water Broadcast

WELCOME to the Wookey Hole stunt on August 17th! This brings us back to the good old days when our "O.B." people did not disdain a touch of the sensational.

Graham Balcombe will attempt to explore the hitherto unknown sixth cave in the Wookey Hole group in the heart of the Mendips. Three caves are open to the public. The fourth and fifth are just accessible when the water of the River Axe is low and a raft can travel under two submerged arches.

Mr. Balcombe intends to explore the sixth in a diving suit.

Danger of Asphyxiation

The relay will begin with a description of the scene by a commentator, and then, while the explorer is seeking his objective, dance music will be broadcast. If and when he reaches the sixth chamber he will broadcast by means of a microphone placed in his helmet.

This part of the relay should be extremely thrilling, for the pumping of oxygen will have to be stopped in order that his words may be heard, but the pumping must be resumed within twenty seconds, or Mr. Balcombe will be in danger of asphyxiation.

Collecting the Money

I HAVE received an interesting communication from the Performing Right Society.

Last year the Society examined 401,315 musical programmes, many of which were broadcast by the B.B.C., and from the Corporation alone was able to obtain £96,000. This sum is divided among the various copyright owners.

The Society's income from broadcasting, according to the annual report, continues to expand with the increase in the number of receiving licences issued, but "the increase is not nearly sufficient to compensate for the disastrous effects which broadcasting has had on the musical profession generally."

The Wireless World

THE
PRACTICAL RADIO
JOURNAL
25th Year of Publication

No. 833.

FRIDAY, AUGUST 16TH, 1935.

VOL. XXXVII. No. 7.

Proprietors: ILIFFE & SONS LTD.

Editor:
HUGH S. POCOCK.

Editorial,
Advertising and Publishing Offices:
DORSET HOUSE, STAMFORD STREET,
LONDON, S.E.1.

Telephone: Hop 3333 (50 lines).
Telegrams: "Ethaworld, Sedist, London."

COVENTRY: Hertford Street.

Telegrams: "Autocar, Coventry." Telephone: 5210 Coventry.

BIRMINGHAM:

Guildhall Buildings, Navigation Street, 2.
Telegrams: "Autopress, Birmingham." Telephone: 2971 Midland (4 lines).

MANCHESTER: 260, Deansgate, 3.

Telegrams: "Iliffe, Manchester." Telephone: Blackfriars 4412 (4 lines).

GLASGOW: 26B, Renfield Street, C.2.

Telegrams: "Iliffe, Glasgow." Telephone: Central 4857.

PUBLISHED WEEKLY. ENTERED AS SECOND
CLASS MATTER AT NEW YORK, N.Y.

Subscription Rates:

Home, £1 rs. 8d.; Canada, £1 rs. 8d.; other
countries, £1 3s. 10d. per annum.

*As many of the circuits and apparatus described in these
pages are covered by patents, readers are advised, before
making use of them, to satisfy themselves that they would
not be infringing patents.*

CONTENTS

	Page
Editorial Comment	161
Choosing a Set	162
Resistance Coupled Push-Pull Amplification	164
Listeners' Guide for the Week ..	166
Complete Show Report	168
Current Topics	192
Lost Milliwatts	193
Broadcast Brevities	194
The Receiver Through the Factory	195
Unbiased	201
The Ultra 25 Receiver Reviewed ..	202
The Permanent Magnet Industry. IV	204
Exhibitors at Olympia	206
Guide to the Stands	207
Readers' Problems	208

EDITORIAL COMMENT

The Show

Some General Observations

NO visitor to the Radio Show this year could fail to come away without being impressed with the progress which has been made in the design and manufacture of receivers for broadcast reception, and with the substantial and stable state at which the industry has arrived after a number of years of difficult growth.

This is a year in which the industry can be congratulated on several counts. In a previous issue we have already drawn attention to the fact that the reckless reduction in prices resulted in not only the production of shoddy receivers but led to an inexcusable amount of trouble after purchase and the necessity for constant servicing. This year practically no reduction in prices has occurred and everywhere the impression obtained is that sets are better built and promise well as regards freedom from trouble.

Quality of reproduction has received closer attention from designers, and variable selectivity, or at least the next best thing, variable tone control, have been introduced generally in place of the fixed compromise between selectivity and quality which has formerly set a limiting standard on the musical reproduction of receivers.

The design of the better-class receivers has, in fact, reached a point where the close proximity of broadcasting channels under the present broadcasting system in Europe decides the upper-frequency range in reproduction which is permissible. Really high quality is only obtainable from local stations or from transmitters which are sufficiently powerful to mask interference from adjacent stations. Unfortunately, not all the countries of Europe show an equal interest in

endeavouring to give listeners really high quality from their transmitters, and they will probably be slow to participate in any international efforts to reduce the number of broadcasting stations and so enable the rest to occupy a wider frequency band.

Another factor which in many districts sets a limit to uninterrupted reception with high quality is electrical interference, the remedies for which, although available, are being so slowly applied. However, the fact that so many of the better receivers have facilities for varying the frequency response enables high quality to be received by the listener wherever conditions permit, and as sources of interference are gradually eliminated it will become possible to work these receivers to the best advantage on an increasing number of stations.

A Noteworthy Innovation

In a recent leader we deplored the slowness of any progress towards the elimination of electrical interference and particularly of any move to make illegal the production of unnecessary electrical disturbances.

It is gratifying to find at Olympia evidence that efforts are being made to help in this matter. A special stand arranged by co-operation between the Post Office, the B.B.C. and the Radio Manufacturer's Association is at the service of visitors and information both verbal and in the form of a most interesting and instructive pamphlet is available to the public.

This is the first time that a stand of this kind has been arranged at the Show although the Post Office alone has at previous Shows demonstrated various forms of interference and the cures. We congratulate all those concerned in these present endeavours, but we look forward to an early move to introduce the necessary legislation.

Choosing a Set



It is Not a Problem if
You Stop at the Cabinet

CHOOSING a set is a problem which increases in difficulty in proportion to the knowledge of the purchaser. It is simple to select a set by its cabinet, but in this article readers are reminded that there are other points which count.

THIS year the array of receivers offered us by manufacturers seems more bewildering than ever; not that the choice between types is confusing, for there are really only three of these: the small straight-circuit receiver costing less than eight or nine pounds, the popular superhet costing from £9 to £18, and the luxury radiograms which may cost anything up to, say, 200 guineas. Apart from the first question of mains supply, the decision as to which class of instrument one will buy is more a financial than a technical problem.

The real difficulty in the choice of a set, if it is to be of the "popular" priced type, lies in the more or less uniform attributes these possess.

There have been no revolutionary developments since the last Exhibition, and for the first time manufacturers are faced with a "show" without any "stunts" to catch the public's fancy. Designers, having no real novelty on which to expend their enthusiasm, have concentrated on reliability and improvements, and the technique of AVC, and have produced receivers which represent better value for the price than at any previous Exhibition. The important features seem to be reliability, consistency of performance, and quality of reproduction.

It is unfortunate that, except for the last, the uninitiated buyer has no criterion by which he can judge; he has to depend on appearance and sales talk, and it is a notorious fact that the design of the cabinet is the most important selling feature to the general public. To the experienced wireless listener, however, there are many points worthy of consideration in the choice of a set.

The first is mains supply. Nearly 40 per cent. of the models contemplated for this year are universal AC/DC sets and, as the design and standardisation of the 13-volt valve has enabled their efficiency to be made equal to those with the special 4-volt AC valves, there is no handicap against the DC mains user. Where there

is no electric supply the choice, of course, is limited to battery sets.

For those who can afford it there is no apparatus which can give greater pleasure than the luxury radiogram, ranging from 60 guineas to 200 guineas. The choice in this case is merely a matter of the extent to which luxuriousness can be indulged. These receivers are all equipped with record-changing devices, the radio chassis are highly developed superhets, while the amplifiers are designed to give superlative quality both on radio and gramophone. Amongst them are several makes of individually designed receivers built with realism as the first consideration. The standard of excellence amongst them is limited only by the restrictions of our broadcasting systems.

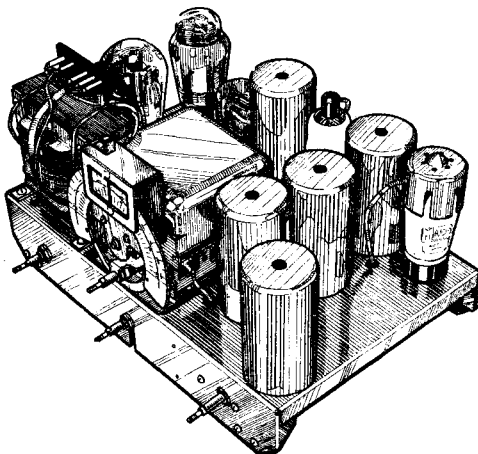

"The thoroughness of the workmanship can usually be judged by the exterior of the chassis." This drawing is of the chassis of one of the Murphy receivers.

The smaller brethren of these Goliaths of the radio world, the radiograms at between 20 and 30 guineas, are merely the gramophone models of the popular table types, with or without record changers.

It is amongst the popular sets, which constitute nearly 90 per cent. of the production, that the greatest indecision must be felt. The differentiation between the

numerous makes and models exists only in minor details.

There is still a great and unhealthy divergence of opinion as to what constitutes pleasurable listening, and this is the first test that should be applied to a receiver. The exigencies caused by overcrowding of the ether limit the frequency response, but the various expedients to which designers resort in attempting to counteract the deficiencies of the broadcasting systems can have very disastrous effects on the quality. Before buying a new set it is advisable to refrain from listening to the old one for a day or two, or, preferably, to listen to a good orchestra and to make a mental picture of the composition of the instruments. Only by doing so can the mind be freed from prejudices which have been caused by resonances, lack of top-note response or of bass, or both. The only way to estimate the quality, or, if you prefer it, tone, of a set is to methodically listen to various types of broadcast transmission, and particularly to the human voice. On direct transmissions from the studio there should be no stridency of violin or piano, and no "boom" in the voice. In making these tests it must be borne in mind that any sign of overloading will immediately bring out all the speaker and cabinet resonances. If the set is to become a real friend it must be free from jarring notes and, contrary to accepted dogma, I believe that, although the human ear can become accustomed to omissions in the frequency scale, the longer one listens to a set with resonances, the worse the reproduction appears to become.

Apart from a frequency range with amplitude distortion, there is also the question of response to transients. Resistance-capacity coupling and the use of high-slope pentodes enabling the output valve to be fed directly from a diode detector has improved the reproduction of transients to such an extent that, on an average set, drums, castanets, and even cymbals can be heard with something approaching recognisable realism.

After the receiver has passed the "companionable quality" test the next

Choosing a Set—

feature to consider is ease of control. Practically all dials are now calibrated by giving the names of the stations, and if these are not as accurate as the superhet system allows, very great annoyance can be the lot of the unfortunate "foreign listener." To include the names of every station even a cheap superhet capable of receiving with a fairly good aerial would take more space than is allowed on the average dial, and it is necessary to check only the principal stations at both ends of the scale, Fécamp and Budapest, with, say, a careful examination of the pointer at Rome and Stockholm. These latter stations are only 9 kc/s apart, and any irregularity in the ganging will show up distinctly.

When turning the tuning knob, particular attention should be paid to the noise, or absence of it, between the stations. The surest test of the efficacy of an automatic volume control or noise-suppressor system is the practical manipulation of the tuning. Before forming any decided opinion, however, it is advisable to read the instructions carefully, as has so often been urged in *The Wireless World*. There may be a "noise-suppressor" switch at the back of the chassis, or some other means of controlling the minimum signal voltage. If this be the case the control should be adjusted to the best compromise between noisiness and sensitivity.

Importance of AVC

In nearly all this year's sets the AVC is brought into operation in such a way that the ear-rending hiss and splash of sidebands is almost entirely eliminated, but it is preferable to make a note of the effect of slight detuning. Where tuning indicators are used they give definite evidence of the correct tuning point on powerful stations, but with low-power stations, which produce voltages at the second detector on or below that of the delay bias, the indicators are inoperative, but as the maximum signal strength has to be used to obtain comfortable volume there is no need for electrical evidence of the presence of station. It is well known that a third of the users of wireless sets operate their controls in a manner that would send the designers into paroxysms of scientific rage, and on such listeners

as these highly commendable refinements are wasted. The decision as to what is tolerable must rest with the listener.

On cheaper models of "straight" sets there is, of course, the aggrieved question of selectivity, and again the user must be the judge; but one word of caution to the uninitiated should be given by the enlightened readers of *The Wireless World*—that where the price is not the major consideration, unless the improvement in the quality given by the straight

Do not forget to see if the set of
your choice has been reviewed in
The Wireless World.

set over the superhet is obvious, the choice should fall on the latter.

The last point for careful consideration—one which should really come first—is reliability. In the past listeners have developed prejudices either for or against particular makes of set, their opinions being governed by the number of service visits the set has required and the promptness and efficiency of the firm's engineers. Manufacturers are beginning to recognise that in the future goodwill will depend more on these attributes than on stunt selling, and in most of this year's models it is obvious that ingenuity and money have been expended in making instruments more dependable and more easily serviced when they do require attention. The thoroughness of the workmanship can usually be judged by the exterior of the chassis. If this is compact and well finished it may be taken for granted that the standard of the workmanship inside is of the same order.

The main causes of trouble in the past have been volume controls and wave change switches (apart from valves). As volume controls are now used on the LF sides of the sets in positions where only a negligible DC current is being dissipated, the dangers of trouble from crackling are minimised, but the smoothness of the control should be tested.

Very few switches are trouble-free from the corrosive effects of our atmosphere, and the principal safeguard must be against mechanical trouble with the contacts. When a receiver is switched to

the medium waveband the majority of the contacts should be closed, and a gentle tap on the switch knob will reveal any defect. A sign of crackling before purchase is a definite warning of future worries.

A solidly built set should not evince any disagreeable characteristics when the top or side of the cabinet is given a gentle blow; but a set with slovenly made connections will expostulate with groans or machine-gun fire.

Despite the obvious disadvantages of the popular set regarding real quality reproduction, manufacturers have made some attempt to give well-balanced quality which appears crisp and unforced. The finer points of the superhet seem to have been appreciated and, combined with the reliability competition, sets this year show a decided improvement on those of the last two years. It was only three years ago we were paying from £15 to £20 for a straight three-valve set capable of bringing in six or seven stations. We can now buy one which can, with greater comfort, guarantee us a log of from twenty-five to forty stations, at prices ranging upwards from £9. Except for the limitations of power output, there is little between the performance that can be expected from a battery set and its mains counterpart. The only additional precaution the purchaser of a battery set has to take is to ascertain how long his HT battery is likely to last with reasonable use. As he is not likely to be convinced on this point until the battery has dropped below the minimum voltage required, possibly two or three months after purchase, he has to take the makers' bona-fides into account. Manufacturers are now more conscientious in their sales talk of current consumptions and battery capacities.

In fact, except for the elementary precautions outlined, some trust must be put in the manufacturer who makes the set and the dealer who sells it. The intimate weaknesses are not likely to become apparent until a later date, if, indeed, they ever reveal themselves. Whatever set you buy, there is always another which might have pleased you more in one or other respect, and the choice of a replacement—or additional set—is a matter of how much "value" is placed on the particular feature.



"Before buying a new set . . . listen to a good orchestra."

Resistance Coupled Push-Pull Amplification

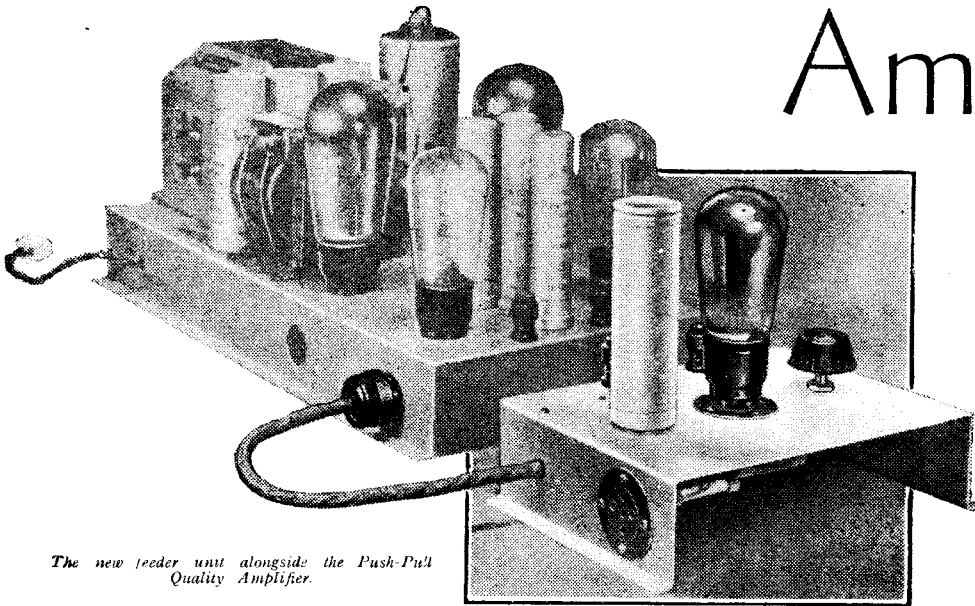

The new feeder unit alongside the Push-Pull Quality Amplifier.

PUSH - PULL amplification is recognised as the best system for ultra-high quality apparatus, and resistance coupling is usually also considered desirable, but it is not always easy to obtain the phase reversal necessary for push-pull without using a transformer. In this article a special phase-reversing feeder unit is described which enables any resistance coupled push-pull amplifier to be operated from a conventional detector system without a transformer; it is designed specially for the "Wireless World" Push-Pull Quality Amplifier.

New Feeder Unit for the Push-Pull Quality Amplifier

By W. T. COCKING

THE WIRELESS WORLD Push-Pull Quality Amplifier has firmly established itself as ideal equipment for high-quality reproduction. The degree of perfection achieved is perhaps best realised when it is remembered that even now, some eighteen months after the original description in *The Wireless World* for May 11th and 18th, 1934,¹ its performance cannot be improved nor can the same performance be obtained in any better way. The amplifier is, in fact, as up to date to-day as it was when first designed.

Phase-Reversal

For operation in most circuits the amplifier requires a feeder unit, and where it is intended for gramophone reproduction only, the one originally described is still the most suitable. The same basic method of obtaining the phase reversal necessary for the amplifier is also applicable to radio reception in many cases, and several articles and receivers have appeared employing this system. The methods of feeding the amplifier hitherto published, however, fail or are inconvenient in cases where the tuned circuit which immediately precedes the detector must have one terminal earthed. This happens in many straight sets, and AVC or QAVC systems may render it desirable to have a point of fixed AC potential on the last valve even in super-heterodynes.

A new feeder unit has been designed, therefore, which permits the amplifier readily to be connected to any equipment having one output terminal earthed. Unlike the original unit this new one is not an amplifier, so that for gramophone work it must normally be preceded by an LF stage which will usually be incorporated in the receiver.

Referring to Fig. 1, it will be seen that

by the 1,000 ohms resistance R2 and shunted by a 50 μ F. condenser C2. A conventional resistance coupling is used in the output and the second output terminal is fed from the valve anode. Now when a valve amplifier is used with resistance coupling, the output is 180 degrees out of phase with the input. One output terminal is fed directly in the same phase as the valve, and the other from the output of the valve, so that the voltages at the two output terminals are in opposite phase.

If the full input were applied to the valve, the output at one terminal would be about ten times as great as that at the other, for the valve gives a gain of about ten times.

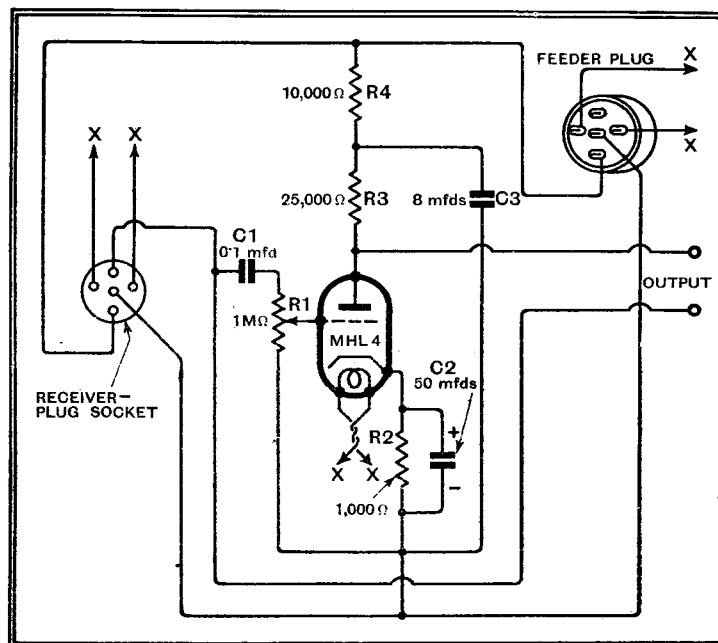

Fig. 1.—The circuit diagram of the unit is shown here. R1 is a balancing potentiometer which permits compensation for any lack of matching of the push-pull valves.

the input lead from the receiver-plug socket is taken directly to one output terminal and also through C1 and R1 to the grid of the valve, which is self-biased

In order to obtain equal output, therefore, the input to the valve must be reduced to about one-tenth of its normal value, and this is done by means of the balancing

¹ These issues were long ago out of print and the construction of the amplifier was described again in *The Wireless World* for February 22nd, 1935.

Resistance Coupled Push-Pull Amplification— resistance R₁. This resistance is not a volume control but a balancing resistance which is adjusted once and for all; it not only permits the outputs of the feeder unit to be equalised but compensates for variations in the gain of the two halves of the amplifier itself, and hence for mismatching of valves.

The method of connection to the amplifier is simple, and the unit should be placed alongside the amplifier. The ter-

minals on music no silent point may be found but only a minimum. The input should be no greater than necessary, for if too large there will be no silent point even on a single-frequency input, as amplifier overloading will introduce a second harmonic which will clearly be audible as a double-frequency note at the balance point. This, of course, is due to the fact that with the temporary output transformer connections the amplifier no longer balances out second harmonics.

phase-reversing valve which feeds the other half of the amplifier. A total input equal to the voltage needed to drive one side of the push-pull chain, or one-half of the total amplifier input, can thus provide the full voltage required.

Conventional couplings to a receiver may be used, and the input can be derived directly from a diode or other detector. With the former, an LF stage will usually be interposed, for such a stage can readily be made to give the additional amplification needed for gramophone. The details naturally depend upon the particular receiver employed, so that in a general article of this nature it is impossible to be precise. No difficulty should be met with, however, if it be remembered that the connections between this unit and the receiver differ in no way from those which would be adopted if this unit were the input of a conventional amplifier.

It should be mentioned that the 1936 AC Monodial can be used with the Push-Pull Quality Amplifier with the aid of this unit, but that other modifications are advisable. These modifications will be fully described in a forthcoming issue of *The Wireless World*, and those who wish to employ this receiver with the Push-Pull Quality Amplifier are advised to wait for the appearance of the article.

LIST OF PARTS

After the particular make of component used in the original model, suitable alternative products are given in some instances.

- 2 Valve holders, 5-pin
Glix Chassis Mounting Standard Type (Belling-Lee, Goltone)
- 1 Fixed condenser, 0.1 mfd. tubular, C₁
Dubilier 4503 or T.C.C. 250
- 1 Fixed condenser, 50 mfd., 12 volts, electrolytic, C₂
Dubilier 3001 or T.C.C. "AT"
- 1 Fixed condenser, 8 mfd., 460 volts peak, electrolytic, C₃
Dubilier 0281 or T.C.C. 802
- 1 Potentiometer, non-taper, 0.1 megohm, R₁
Reliance STW
- 1 Resistance, 1,000 ohms, 1 watt, R₂
Dubilier
- 1 Resistance, 25,000 ohms, 1 watt, R₃
Dubilier
- 1 Resistance, 10,000 ohms, 1 watt, R₄
Dubilier
- (Amplion, Bryce, Eric, Ferranti, Graham-Farish, Claude Lyons, Polar-N.S.F., Watmel)
- 1 4-way connector
Bryce

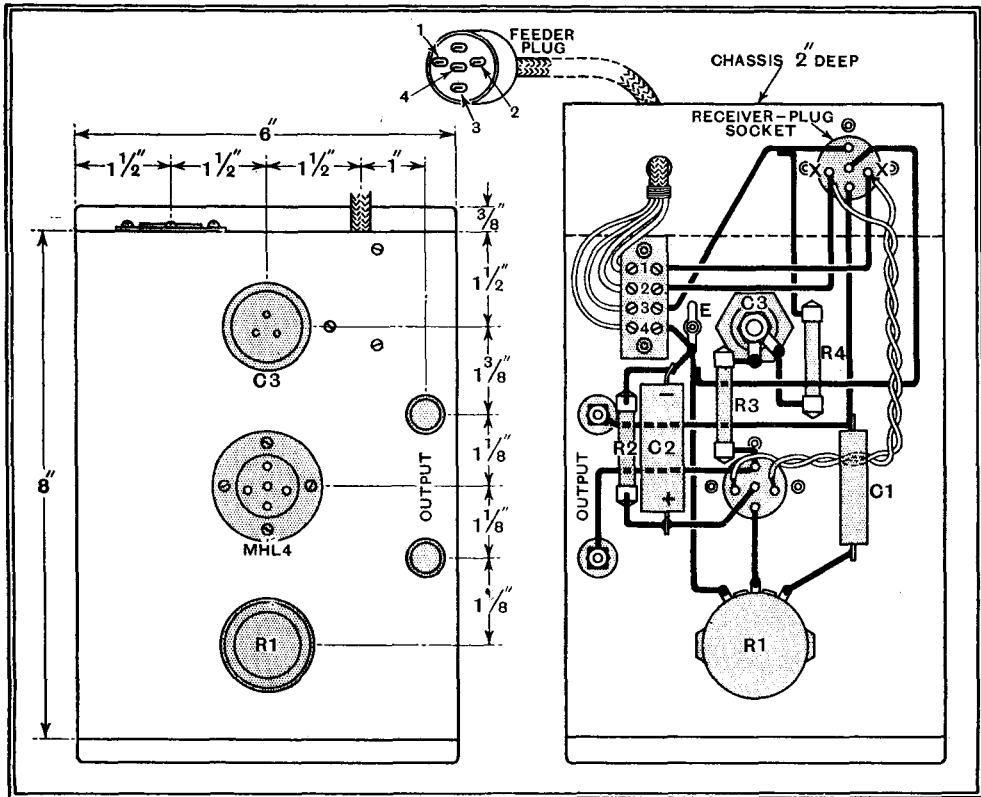

The construction and wiring are clearly shown in these drawings.

minals are then connected across and the plug on the unit inserted into the socket on the amplifier, the cable employed being as short as possible. Provided that the current requirements of the receiver are within the capabilities of the amplifier, it is only necessary to insert the receiver-plug in the socket on the unit, for the standard connections are adhered to.

Balancing the Amplifier

For adjusting the balancing resistance R₁ the following procedure must be carefully followed. Rotate R₁ anti-clockwise as far as possible. Switch on and tune in a signal. The amplifier may motor-boat gently, but ignore this. Having obtained a signal, switch off and disconnect the anode lead of one PX₄ output valve from the output transformer (this may be done at the transformer) and join it to the anode of the other PX₄. The two wires which normally go to the two outer transformer terminals should thus be joined to one and the same outer terminal only. Switch on, and when the valves have warmed up, slowly turn R₁ clockwise until a silent point is found. The balance is best carried out on a pure note, such as the B.B.C. tuning signal, for if done

When the balance point has been found, switch off and replace the output transformer connections to normal, and the equipment is then ready for use. Full output is obtained when the feeder unit has an input of about 3.5 volts peak.

The Quality Amplifier itself, of course, needs a total input of some 7 volts peak, so that this feeder-unit does give an amplification of two times. This is not amplification in the true sense of the word,

The unit should be mounted at the side of the amplifier and the terminals connected across.

however, for the output of the valve used is no greater than the input to the unit. What actually happens is that the input to the unit feeds one half of the amplifier directly, and this same input operates the

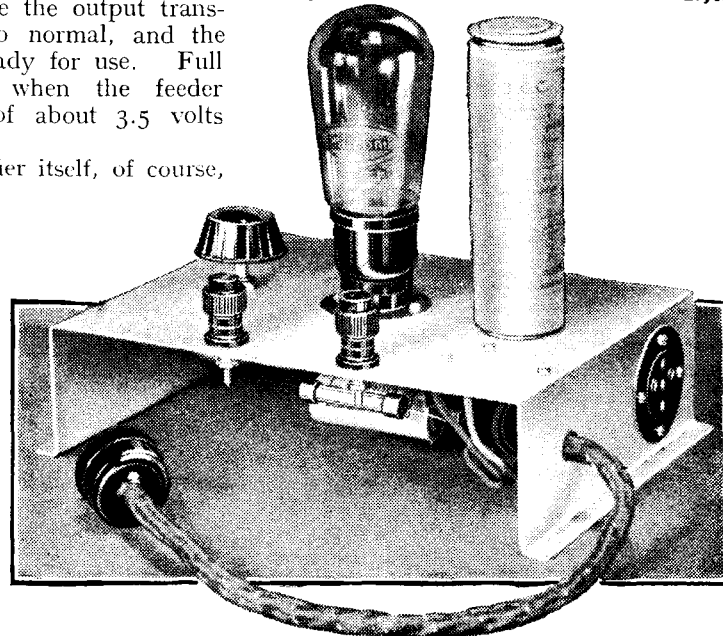

- 2 Ebonite shrouded terminals
Belling-Lee "B"
- 1 4-way cable 12in., with twin 70/36 leads and 5-pin plug
Goltone
- (Bulgin)
- Small quantity of No. 16 tinned copper wire, Sistoflex, Aluminium, etc.
- Screws: 1 6BA, 1/4in., 9 6BA, 1/4in.
- 1 Valve
Marconi or Osram MHL4

Listeners' Guide for

Outstanding Broadcasts at Home and Abroad

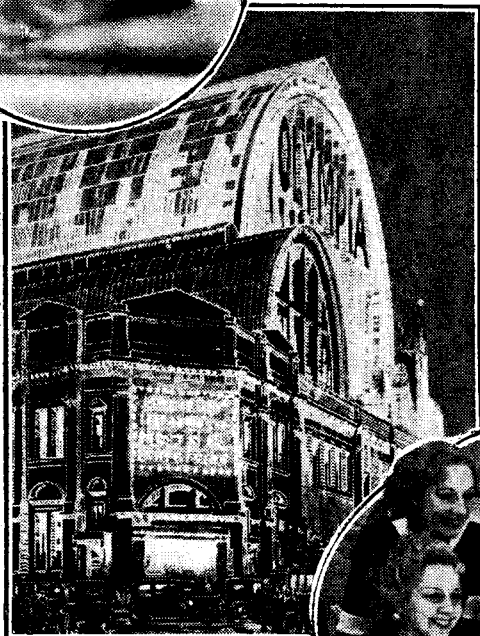

RADIOLYMPIA ON THE ETHER. Echoes of the Radio Show are reverberating around the country in the broadcasts from the B.B.C. Theatre adjoining the Main Hall. "Saturday Night at Olympia" will be broadcast to-morrow (National, 8), and another relay will be given on Monday (National, 8). The Radiolympia Girls, seen below, are appearing at all the shows. Jenny Howard (inset) is heard with Percy King in a song and dance act.

this tense atmosphere in a certain harbour a few days before the declaration of war between England and Germany, and the details in the radio play are meticulously accurate.

The B.B.C. warns listeners that, on the occasion of a previous broadcast, some people found "In the Shadow" rather too gripping. Peter Cresswell is the producer.

SALZBURG FESTIVAL

PROBABLY the most noteworthy of all the relays from the Salzburg Festival will be that of Mozart's "Il Seraglio," Acts I and II, on Wednesday next, August 21st (National). The Vienna Philharmonic Orchestra will be conducted by Bruno Walter, and the singers will include Lotte Schöne, Margherita Peras, and Alfred Muzzaelli.

On the previous evening Radio-Paris and other French stations will be relaying a Mozart Symphony concert from the Residenz, Salzburg, at 9.10, the conductor being Bernard Weingartner.

TOURING ITALY

THE Italian stations are broadcasting regular travel talks calculated to encourage touring in Italy. At 7.40 on Tuesday next, a talk in English on "The Highways of Italy" will be relayed by Milan, Rome and Turin.

DANGEROUS CORNER

PERHAPS a little exhausted, like a pedestrian who has traversed a Belisha crossing with only a few inches to spare, the B.B.C. has negotiated the dangerous "off" season and is now clinging to that substantial beacon nicknamed the "Proms."

A "Prom" in time saves nine; in other words, the Output Department can rely upon Sir Henry Wood and the Orchestra to provide a goodly percentage of each evening's entertainment.

THE SECOND WEEK

VERY good entertainment they provide, too. Monday next, the opening night of the second week of the Proms., concerts will, as usual, be devoted mainly to Wagner and will include the "Lohengrin" Prelude and the famous March from "Tannhäuser." A Mozart-Haydn programme will be given on August 20th, and a Brahms concert on the following evening.

Schubert's Unfinished Symphony will be heard in the mixed programme on August 22nd, which also includes Arnold Bax's Symphonic Variations for pianoforte and orchestra, with Harriet Cohen as soloist. Beethoven night on Friday will include the First and Seventh Symphonies.

Saturday is a "popular" night with such favourites as Wagner's "Flying Dutchman" overture, Brahms' Variations on a Theme of Haydn, and the Flower Song from "Carmen."

"IN THE SHADOW": B.B.C. WARNING

Two ships lying parallel to each other in a naval harbour do not ordinarily suggest material for drama, but when

their respective countries are on the point of declaring war on each other we have all the ingredients for excitement. This situation will be portrayed in "In the Shadow," a radio drama written by a naval officer, Horton Giddy, to be revived on August 21st (National, 9) and August 22nd (Regional, 9.15). As can be imagined, each watches the other like a bird watching a stoat. The author experienced

ITALIAN OPERA FROM VICHY. The world-famous Casino, from which a series of Italian operas is being broadcast throughout the month by the majority of French stations. An Italian Festival Concert, conducted by Emily Cooper, will be relayed from the Casino by Radio-Paris at 8.45 p.m. on Monday next.

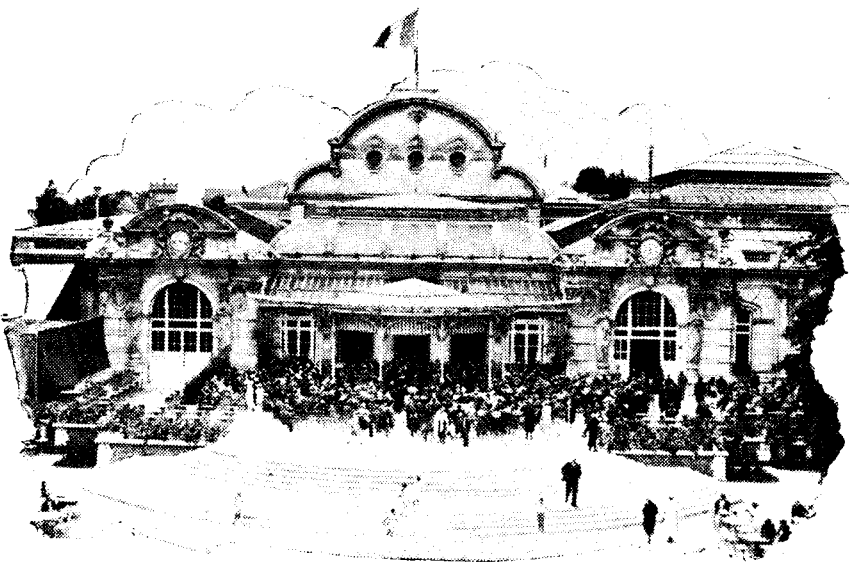

the Week

HIGHLIGHTS OF THE WEEK

FRIDAY, AUGUST 16th.
Nat., 8, "Pleasant Portion"—radio drama by Barbara Couper. 9, B.B.C. Military Band
Reg., 8, Beethoven Promenade Concert. 9.35, The Vario Trio.

Abroad.

Berlin (Funkstunde), 8.10-12, Gala Concert for opening of Radio Exhibition.

SATURDAY, AUGUST 17th.

Nat., Throughout day: Commentaries by Capt. Wakelam on England v. South Africa Test Match at the Oval. 8, Saturday Night at Radiolympia. ¶B.B.C. Orchestra (C).

Reg., Promenade Concert. ¶A Diver explores the Wookey Hole, Wells, Somerset.

Abroad.

Brussels I, 8, Festival Concert celebrating Jubilee of Belgian Labour Party.

SUNDAY, AUGUST 18th.

Nat., Reginald King and his Orchestra. ¶Leslie Jeffries and the Grand Hotel, Eastbourne, Orchestra.

Reg., Band of H.M. Coldstream Guards. ¶London Zigeuner Orchestra. ¶Short Story: "The Ass Who Dreamt," by John Pudney. ¶Gershon Parkington Trio.

Abroad.

Vienna, 8.40, Concert from Salzburg Cathedral.

MONDAY, AUGUST 19th.

Nat., Commentaries on England v. South Africa Test Match. 8, Variety from Radiolympia. ¶Gershon Parkington Quintet.
Reg., Wagner Promenade Concert, Violin Recital by Szigeti.

Abroad.

Brussels II, 9, Symphony Concert from International Exhibition.

TUESDAY, AUGUST 20th.

Nat., Test Match Commentaries. ¶Mountain Ballads and Cowboy Songs by Phyllis Scott (soprano) and John Rorke (baritone). ¶Mozart-Haydn Promenade Concert. ¶"In the Shadow of the Taj."

Reg., 8, "Mystery of the Seven Cafes." ¶B.B.C. Orchestra (C).

Abroad.

Sottens, 8.40, Hungarian and Gypsy Music.

WEDNESDAY, AUGUST 21st.

Nat., 7.15, "Il Seraglio," Acts I and II, relayed from Salzburg. ¶"In the Shadow."

Reg., "From One Band to Another." ¶Brahms Promenade Concert.

Abroad.

Deutschlandsender, 8.45, Humorous Musical Play: "The Wolf Orchestra Howls."

THURSDAY, AUGUST 22nd.

Nat., B.B.C. Dance Orchestra. ¶Promenade Concert.

Reg., 8.15, Bands of H.M. Coldstream, Scots and Welsh Guards at Shrewsbury Musical Fete. ¶"In the Shadow."

Abroad.

Leipzig, 8.30, Grand Variety Concert from Berlin Radio Show.

CONTRASTING STYLES

A FURTHER "One Band to Another" broadcast will be given in the Regional programme on Wednesday next, August 21st. As usual, the bands chosen offer a striking contrast in style and technique. They are Harry Leader and his Band, who have previously been heard at the microphone on several occasions, and Younkman's Czardas Band, a gypsy orchestra well known to London and provincial cinema audiences.



FROM THE BERLIN RADIO SHOW

ON Sunday next a special broadcast at 8 p.m. from the Berlin Radio Exhibition will be relayed by most of the German stations. An opportunity is to be given to persons from all over the country to perform before the microphone. They are required to pass a preliminary test and must be able to prove their Aryan descent.

Further exhibition broadcasts will be on Monday via Frankfurt (8.10); Tuesday, Stuttgart (8.10); Thursday, all stations (8.30).



A SWEDISH CROONER

SWEDEN'S "Bing Crosby" broadcasts from Kalundborg at 8 on Monday. He is M. Sven-Olof Sandberg, the country's leading crooner, and he will give a programme of modern rhythm songs accompanied at the pianoforte by Mme. Sandberg.



LITTLE-KNOWN OPERAS

THOSE who want something new and untried in operas should tune in "The Miracle," by Laccetti, which is being broadcast from Rome tomorrow evening at 8.40. Another relatively little-known opera, which figures in the Radio-Paris programme tomorrow night, is Saint-Saëns' "Phryné," first produced in 1893, dealing with the life of the celebrated courtesan of ancient Athens.

Another opera worth tuning in for five minutes—and listeners may linger longer when they hear it—is "Hans Heiling," written by Marsch-

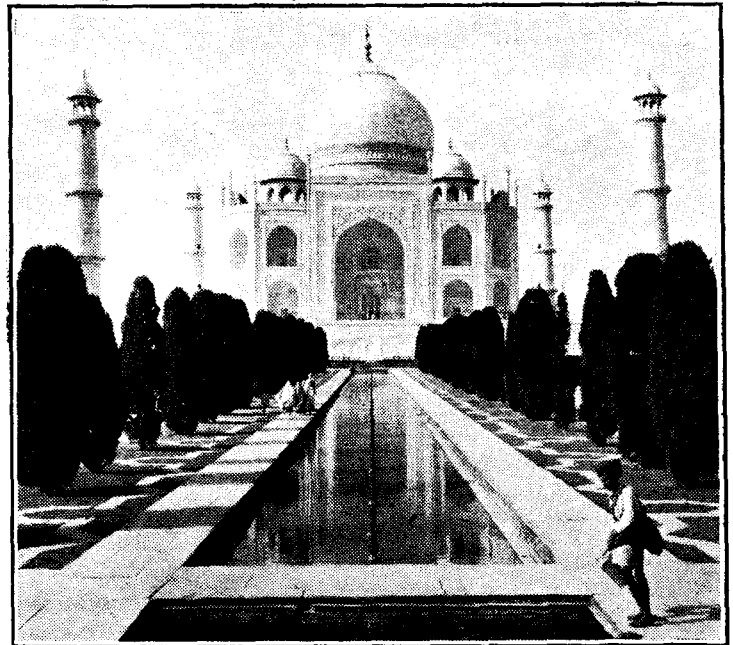

TOMB OF A BRIDE. The Taj Mahal, Agra, which will be the subject of a radio travelogue, "In the Shadow of the Taj," to be broadcast by the B.B.C. on Tuesday next (National, 10). Dewan Sharar, the author, will act as guide, and the tragic story of the building of the Taj will be unfolded by Sourya Sena, the well-known Sinhalese singer.

ner, a youthful friend of Beethoven. This is a perennial favourite in Germany, and will be broadcast from Hamburg at 8.10 to-morrow evening.



"LOHENGRIN" FROM MUNICH

THE Salzburg Festival tends to overshadow all other musical events on the Continent. Wagner lovers, however, will tune in a "Lohengrin" relay by Munich from the Wagner Festival in that city on Tuesday, August 20th. The relay will be given at intervals from 5 to 10 p.m.

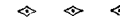

OPERETTAS

LOVERS of lighter musical fare are not so lucky this week. There is, however, Oscar Strauss' sparkling operetta, "La Teresina," thoroughly at home in the French language and with a French cast, which Sottens is giving us at 8.15 on Saturday. On Thursday, the 22nd, Brussels No. 1 broadcasts Lehar's ever-popular "Count of Luxembourg," which also happens to slip into more or less native surroundings in Brussels, and is much in request on the Belgian stations. The young Czech composer, Jaromir Weinberger, who has already some seven or eight operettas to his name, is represented by a somewhat unfamiliar one, "Der Frechling" (The Cheeky Fellow), which Vienna is broadcasting at 7.15 on Saturday.

A VISIT TO INDIA

A NEW form of entertainment—a radio travelogue—will be given in the National programme on Tuesday next, August 20th. It will be built around one of the most charming and pathetic love stories of all time, that of Shah Jehan, who, when his wife, Mumtaz Mahal—the "Glory of the Palace"—died, built for her that world-famous mausoleum, the Taj Mahal.

The travelogue, "In the Shadow of the Taj," is by an Indian author, Dewan Sharar. Listeners will be able to join in fancy a party of tourists who are shown over the Taj by an Indian guide, who will describe its architectural glories; a Khardim will relate the story of Shah Jehan and his tragic bride.

THE AUDITOR.

30-LINE TELEVISION

Baird Process Transmissions.
Vision, 261.1 m.; Sound, 296.6 m.

MONDAY, AUGUST 19th.
11.15-12.0 p.m.

Vera Lavrova (Dances); Marie Dayne (the comedienne with an entirely different style); Ronald Chuter and Tommy Hayes (dancers in hot rhythm); George Buck (comedian); Sydney Jerome at the piano.

WEDNESDAY, AUGUST 21st.
11.0-11.45 p.m.

Gueda Waller and Vera Maconochie (animal nursery rhymes); Morgan Davies (songs); Doris Sonne (dances); Travis Kemp (dances); Sarah Allgood (Irish monologues).

Your Guide to Olympia

WEDNESDAY, AUG. 14th, TO
SATURDAY, AUG. 24th,
11 A.M. TO 10 P.M.

ACE RADIO (97)

This stand is occupied by receivers of various types, including a five-valve superheterodyne which is fitted with AVC, interstation noise suppression, and a shadow-tuning indicator. It is listed at 10 guineas in both AC and AC/DC models and is also available as a radio-gramophone, for AC only, at 18 guineas. An all-wave AC/DC superheterodyne covering the band of 15/2,000 metres is also shown at 12 guineas. Straight sets are represented by three models, one battery, one AC, and one AC/DC. These receivers are essentially alike and differ only in those matters dictated by the different supply systems.

Ace Radio, 2-5, Dingley Place, City Road, London, E.C.1.

ADEY (1)

An all-wave receiver of the portable type, designed for Empire use, is a feature of the show on this stand. It is battery-operated and priced at 12 guineas. A portable four-valve receiver of unusually small dimensions and weighing only 12½lb. is another exhibit, and the Standard Model is listed at £7 10s. Small headphone portables are shown, and there is in addition a short-wave converter.

Adey Portable Radio, 99, Mortimer Street, London, W.1.

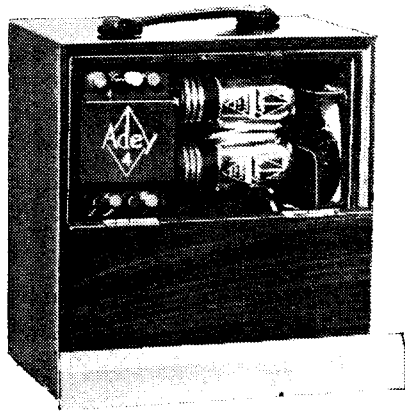

An Adey portable receiver.

AERIALITE (8)

Aerial equipment generally, including ready-made aerials both of the outdoor and indoor varieties, comprise the principal exhibits of this firm. Aerial wire and supporting brackets of various kinds are shown, together with earth tubes and earthing connectors. There is also a series of high-tension dry batteries in which a new method



COMPLETE

of inter-cell insulation, designed to reduce noises, is employed.

Aerialite, Ltd., Junction Mills, Whittington Street, Ashton-under-Lyne.

AERODYNE (72)

The Aerodyne range of new season's receivers includes six models, three being for battery operation and the remainder mains-driven. The majority are fitted with large-diameter 180-degree full-vision scales with station names engraved thereon, while the receiver chassis and loud speaker are mounted side by side, with all the controls neatly grouped on the right-hand side immediately below the scale window.

The cheapest battery model is the "Snipe," which costs £5 17s. 6d., and em-

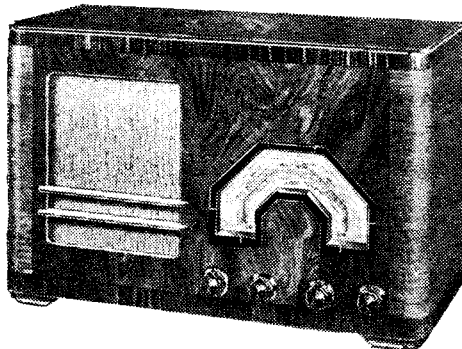

Aerodyne "Silver Wing" superheterodyne.

bodies a three-valve circuit having an HF stage. Of the mains models, one, the "Silver Wing," is a six-stage superheterodyne, embodying an Octode frequency changer, iron-cored coils, one IF amplifier, diode detector and delayed AVC. It is fitted with an inter-station noise suppressor and the price of the AC model is £11 11s. There is a Universal mains model priced at £12 1s. 6d.

All the Aerodyne models are housed in very attractive and well-finished table cabinets of modern design.

Aerodyne Radio, Ltd., Aerodyne Works, Tottenham, London, N.17.

ALBA (65)

The chief exhibit on this stand is a new all-wave receiver, which is available in several different styles of cabinet work and in both AC and AC/DC models. The tuning ranges are 19/52

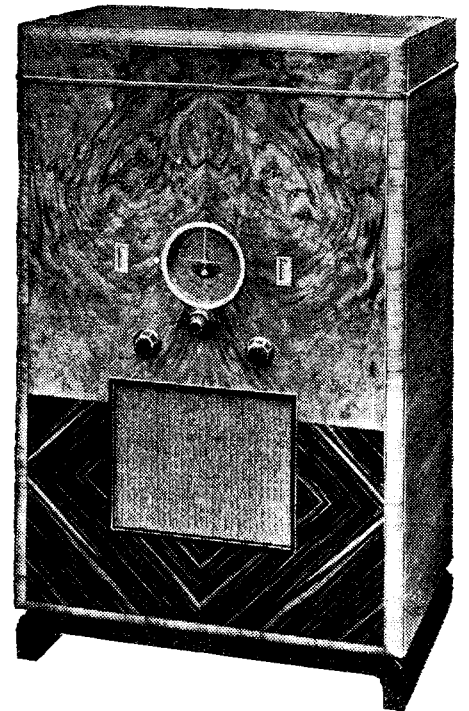

Alba Model 990 all-wave radio-gramophone.

metres, 200/550 metres, and 800/2,000 metres. The set is claimed to be highly sensitive and to include an efficient AVC system. A noise-suppression switch is fitted and the tuning control is of the dual-ratio type with an "airplane" dial. As a table model the set is listed at 16 guineas and at 26 guineas as a radio-gramophone.

The normal broadcast band sets are fitted with searchlight tuning—a system in which the conventional pointer is replaced by a beam of light. AVC is, of course, fitted, and an efficient pre-selector; the output is 3.4 watts. The Model 550 is listed at 10½ guineas. Three-valve straight sets are shown in both battery and mains types, the valves being arranged as HF stage, detector, and pentode output.

A. J. Balcombe, Ltd., 52, Tabernacle Street, London, E.C.2.

ALL POWER TRANSFORMERS (211)

Mains transformers and LF chokes constitute the principal interest of this exhibit. There are models for every wireless pur-

SHOW REPORT

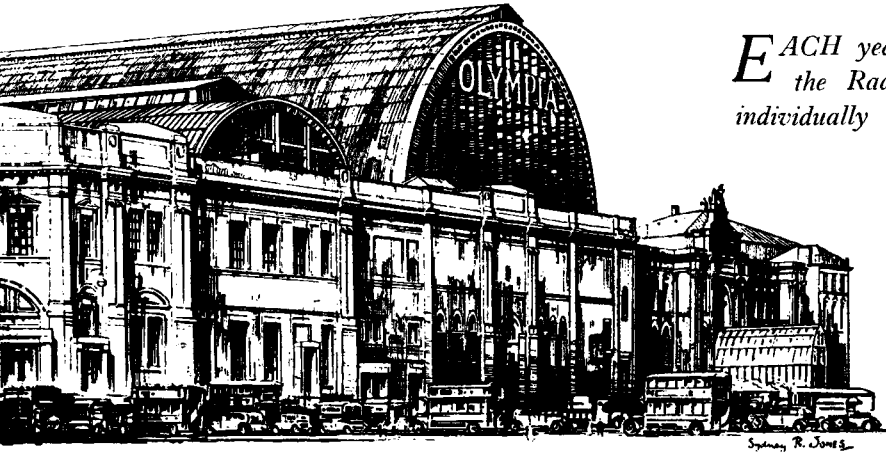

EACH year "The Wireless World" compiles a full report of the Radio Show dealing with the exhibits on each stand individually and endeavouring to give readers a comprehensive review which will be of value not only as a guide when visiting Olympia but also as a permanent record through the season of the new products which the Show has revealed.

pose; they range in sizes from small transformers for simple mains sets to those capable of operating large public address apparatus. The majority of the standard types are completely shielded.

All Power Transformers, Ltd., 8a, Gladstone Road, Wimbledon, London, S.W.19.

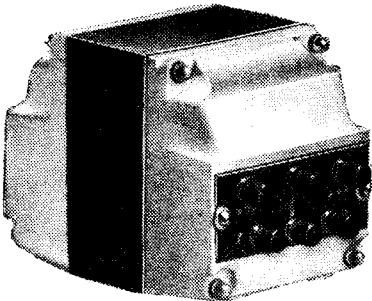

"All Power" shrouded mains transformer.

ARDENTE (46)

The activities of this firm are devoted mainly to the production of amplifiers for public address work, deaf-aid equipment and associated apparatus. This year they are showing a series of radio-gramophones fitted with large power LF amplifiers ranging from 10 to 20 watts output. The radio receiver is a five-valve superheterodyne and the gramophone equipment includes an automatic record-changer; also there is provision for operating two microphones.

A mobile amplifier easily and quickly installed in a motor car is a new development; this is for operation from the car starter battery.

A moving coil public address microphone is shown mounted in stands of various styles, costing from 10 to 12 guineas complete.

R. H. Dent, 309, Oxford Street, London, W.1.

ALLWAVE (109)

Pride of place on this stand must undoubtedly be given to the Allwave "Commander" receiver. This set is designed for all-wave operation and covers 12-2,000 metres in five ranges with only one gap between 560 metres and 800 metres. A signal-frequency stage is included and functions on all wavebands, and the IF amplifier is fitted

with variable selectivity. A special type of "folded chassis" has been adopted, which is claimed to eliminate long leads and make individual screening of the coils unnecessary while rendering the components and wiring unusually accessible. The receiver is designed for AC operation and priced at £30.

In addition to this set, a midget portable of the two-valve super-regenerative type is shown. This has three wavebands—short wave, trawler, and medium wave. It is battery-operated and costs 6 guineas.

Allwave International Radio and Television, Ltd., 242, High Street, Bromley, Kent.

AUTOTROPE (87)

The basis of all the instruments shown on this stand is the ingenious record-changer designed to handle from one to thirty mixed records of either 10- or 12-inch diameter. It plays both sides of each record in sequence or one side only as desired and is entirely automatic in operation.

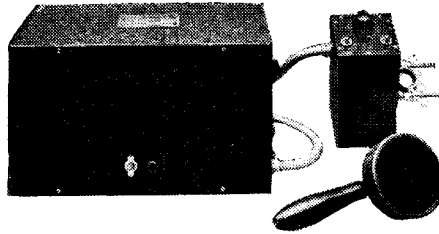

Ardente mobile amplifier equipment.

The Model 1 Series A radio-gramophone incorporates a twelve-valve superheterodyne receiver with dual matched speakers and a paraphase resistance-coupled amplifier with an output rated at 12 watts. This instrument is built to special order and is available in a number of alternative cabinets at prices ranging from 138 to 160 guineas.

A smaller edition of the Series A models incorporating the same record-changer but with a simpler radio receiver specification and an output of 6 watts from the push-pull amplifier, is shown and is priced at 88 guineas.

For those interested only in the local programmes a dual station radio-gramophone is also available at 65 guineas. No tuning is necessary and there is a three-way switch

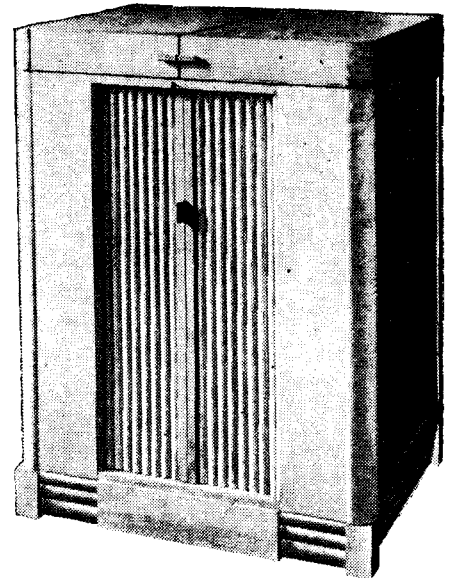

Autotrope Model 1 Series A radio-gramophone.

marked "National," "Regional," and "Gramophone." The power output is 5 watts.

There is also a special automatic gramophone built into a walnut cabinet in which the operation of the record-changer can be viewed through a glass panel. The exhibit is completed by a number of record-filing cabinets of various capacities and types.

Anson and Hopwood, Ltd., 11, Berkeley Square, London, W.1.

AVO (103)

In addition to the well-known range of Avometers, the Automatic Coil Winder Co.

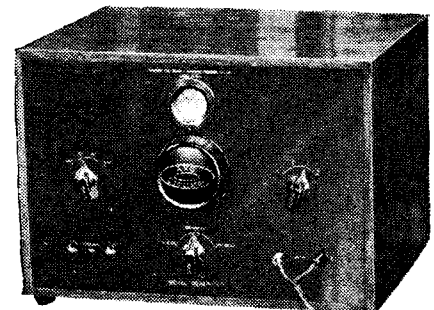

Avo signal generator.

Complete Show Report—

is showing an augmented series of service test apparatus. The new Signal Generator is designed for laboratory and test-room use. Separate valves are employed for the HF oscillator and for the modulator, the latter being controlled by a switch which allows for external modulation if required.

Iron-cored coils are used in the HF oscillator, which also includes waveband switching giving four ranges, 10 to 25 mc/s, 5 to 12.5 mc/s, 500 to 1,800 kc/s, and 100 to 300 kc/s; thus all broadcast, including the short and IF, wavebands are covered. The instrument is entirely self-contained, is battery operated, and costs £15 15s.

There is a portable Avo Oscillator of the service man's type, covering medium, long and IF ranges. It gives a modulated or a non-modulated HF output as required, and the price is £5 10s.

Automatic Coil Winder and Electrical Equipment Co., Ltd., Winder House, Douglas Street, London, S.W.1.

B.T.S. (14)

Components for the short and ultra-short wavebands occupy a prominent place on this stand, and they include valveholders with Megacite insulation, and fixed air-dielec-

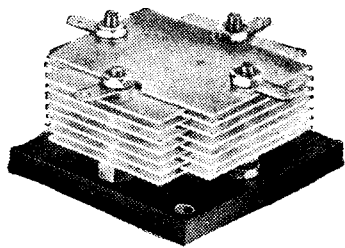

B.T.S. Air-dielectric Condenser.

tric condensers in capacities up to 0.0002 mfd. A short-wave variable condenser with thick silver-plated vanes is shown, and there are ultra-short wave coils wound with heavy-gauge silver-plated wire. Air-dielectric trimming condensers and IF transformers for operation at 12 mc/s are also available.

In addition to such short-wave gear, a wide variety of components for ordinary purposes is on view, including transformers, chokes, condensers, plugs, jacks, and resistances.

British Television Supplies, Ltd., Bush House, Aldwych, London, W.C.2.

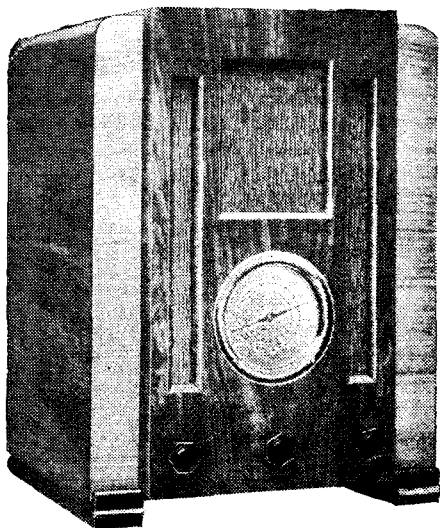

The Beethoven AC 77 Superheterodyne.

BEETHOVEN (60)

The Model 77 receiver on this stand is a superheterodyne of the four-valve type. An octode frequency-changer is used with one IF stage, a duo-diode for detection and AVC purposes, and a pentode output valve delivering 3.4 watts to the energised moving-coil speaker. Special image suppression circuits are included and an "airplane" type tuning dial is fitted. The set is for AC operation and costs 11½ guineas. A similar receiver arranged as a radio-gramophone, model 717, but provided with an extra LF stage, is listed at 22 guineas.

The AC78 receiver is of the transportable type. It is designed for AC operation and includes built-in frame aerials. Three valves are used and arranged as an HF stage, followed by a detector transformer coupled to an output pentode. The price is 10 guineas. Battery receivers also figure in this exhibit and both portable and transportable types. A single HF stage is used and two LF stages.

Beethoven Radio, Ltd., Chase Road, North Acton, London, N.W.10.

BELLING-LEE (91)

The activities of this firm are largely concentrated on the manufacture of devices for the suppression of electrical interference, both for connection to offending appliances and for use at the listener's end.

Apparatus in the latter category will naturally be of the greater interest to the average reader, from whose point of view the most useful devices are probably condenser filters, generally used for connection to the mains input to the building. For this purpose two types are available—the plain bakelite-cased filter, which has been on the market for some time, and a newer pattern, known as the Line Suppressor, which is designed for easy fitting in such a way that the connecting leads are of the extreme shortness that is so desirable. Still another filter, this time of the choke-condenser type, is designed for connection to the power point supplying the set.

Chokes of various inductance values and current ratings for curing the more stubborn cases are also produced, while for use as a supplement to, or instead of, filters, in certain circumstances, there is the "Rejectostat" screened lead-in system. All Belling-Lee apparatus conforms to the B.S.I. specification, and is designed in accordance with Post Office recommendations.

A variety of the well-known Belling-Lee radio connectors—terminals, plugs, sockets, etc.—are shown, together with several new components for ultra-short-wave work.

Belling and Lee, Ltd., Cambridge Arterial Road, Enfield, Middlesex.

BENJAMIN (42)

Probably the most interesting exhibit on this stand is the newly introduced Magnavox Model "Thirty-Three." Technically, this loud speaker has many points

in common with the Model "Sixty-Six" shown last year. The open-type field magnet gives a high flux density (of the order of 11,000 lines under optimum conditions), and with the sensitivity thus pro-

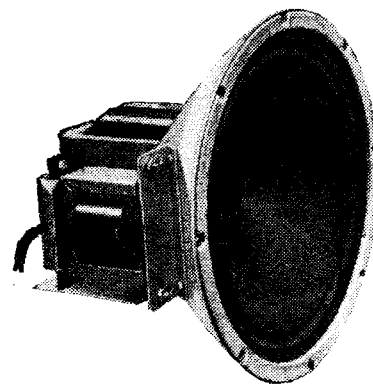

Magnavox (Benjamin) Model "Thirty Three" loud speaker.

vided the normal input required is only 2 watts, though the movement is designed to carry 7 watts. The universal tapped output transformer is fitted at the side of the field magnet, and a hum-bucking coil is connected in series with the 15-ohm speech coil. Field resistances of 1,250 or 2,500 ohms are available, and the price is £3 15s. An AC kit of parts for energising the field from AC mains can be obtained for £2.

The Model "Sixty-Six" is continued

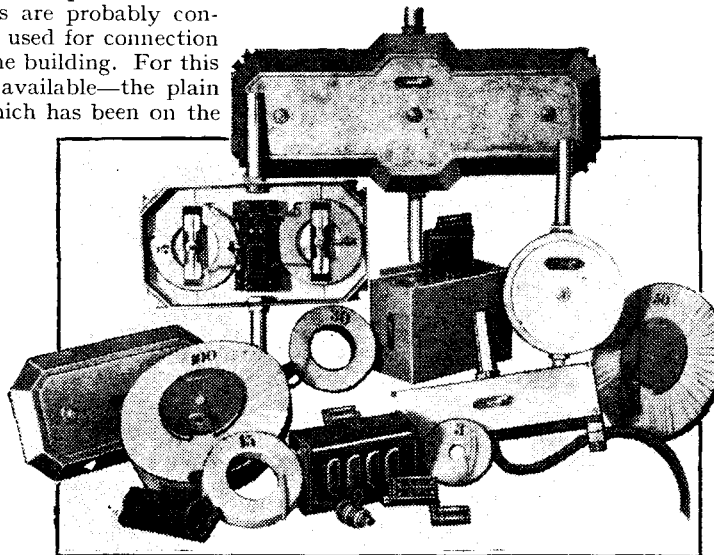

Group of Belling-Lee interference-suppressing devices.

practically unchanged, and it is interesting to note that a special model with a field resistance of 1,250 ohms is now included for use in conjunction with certain "Wireless World" receivers and amplifiers. The DC model costs £5 17s. 6d., and the AC model with amplifying equipment incorporated in the base, £7 17s. 6d.

The exhibit is completed by a range of Benjamin components which include "Transfeeda" intervalve coupling, valveholders, switches, and Class "B" transformers.

Benjamin Electric, Ltd., Brantwood Works, Tariff Road, London, N.1.

BLUE SPOT (28)

Three new receivers constitute the main part of this firm's exhibit. The Model AC5

Complete Show Report—

at 12 guineas is a table model superheterodyne with AVC and positive image suppression. The pentode output valve has an output of 2.6 watts. The chassis is also available in a radio-gramophone cabinet of original design in which the turntable is accessibly situated in a recess below the receiver and above the loud speaker. The price of this model is 21 guineas.

The AC/DC 4 is a universal mains set with a "straight" circuit employing pentode valves throughout. It is designed to be completely shock-proof, and a mains filter circuit is included to suppress interference. The price is 9 guineas.

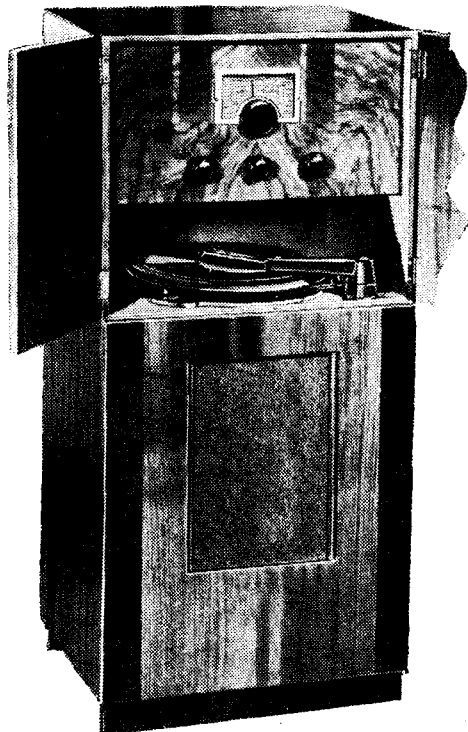

British Blue Spot Model AC5G radio-gramophone.

Lastly, there is the Battery III at £6 17s. 6d., including batteries, which also has a straight circuit. A special battery economy arrangement associated with the pentode output valve gives an acoustic output of 1 watt from the nickel-aluminium magnet speaker for an average HT consumption of 7 mA.

British Blue Spot Co., Ltd., Sterling Estate, Dagenham, Essex.

BRITISH N.S.F. (48)

Polar-N.S.F. components available to the home constructor are shown on this stand. No modifications have been deemed necessary so far, as the designs adequately meet

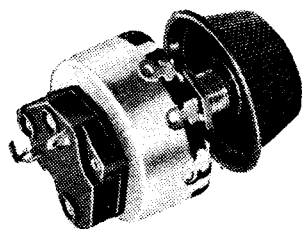

Polar-N.S.F. volume control with switch.

all present-day requirements. The range includes high-voltage dry electrolytic con-

densers, tubular paper dielectric type for 350 volts DC working, one-watt fixed resistors and grid leaks, also a series of carbon-type volume controls from 5,000 ohms to one megohm in value.

British N.S.F. Co., Ltd., Waddon Factory Estate, Croydon, Surrey.

BRITISH PERMEL ENAMELLED WIRE (50)

Enamelled copper wires manufactured by the Permel process are shown on this stand. It is claimed that this coating is virtually free from small pin-holes, and a special demonstration machine is in constant operation which gives a very convincing proof of its insulation.

British Permel Enamelled Wire, Ltd., Charlton, London, S.E.7.

BROWN RADIO (210)

The most interesting of the latest additions to the Brown range of test apparatus is a standard signal generator for AC mains operation. This gives an HF output which can be modulated by the internal apparatus or used with an external modulator as required. A dynatron HF oscillator is employed. High-grade components are used throughout, and every care is taken to ensure that the test set shall provide the high standard of reliability and accuracy required for laboratory investigation of the performance of wireless receivers.

It covers a range of 200 to 3,000 metres, and consists of HF oscillator, modulator, amplifier, modulation meter and power pack. Each of the units is separately screened, and the price complete is £70.

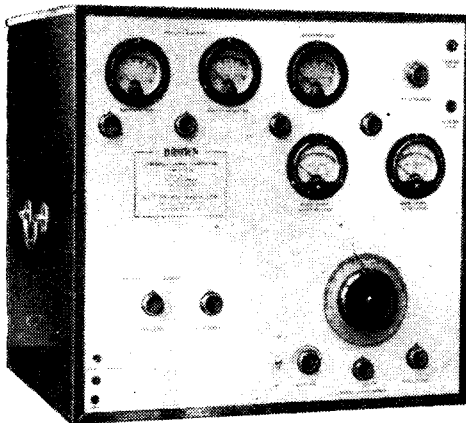

AC mains Signal Generator made by Brown Radio.

This firm is showing, also, a variety of smaller and also portable modulated oscillators, output meters, valve-voltmeters, LF oscillators, and a series of power amplifiers.

Wm. F. Brown Radio Co., Ossillo Works, High Street, Brierley Hill, Staffs.

BROWNING (228)

This firm is showing a range of battery and mains-operated sets, all of which embody straight circuits. The four-valve mains model for AC operation costs £8 8s.; its circuit includes one HF stage preceded by a band-pass filter, and it embodies an energised moving-coil loud speaker. The Universal model costs 9s. 6d. extra. There is a self-contained transportable three-valve set with frame aerial costing £4 10s

Browning Wireless Manufacturers, 18, Shellgrove Road, London, N.16.

BULGIN (117)

So numerous and varied are the components on this stand that singling out a few for mention here is an exceedingly difficult matter, for all hold sufficient interest to warrant a detailed description.

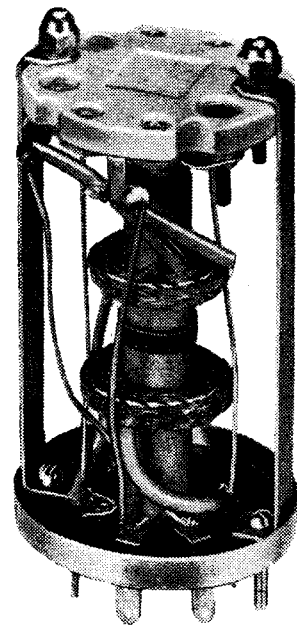

Bulgin variable selectivity 450 kc/s IF transformer

The visitor should not fail to examine the very extensive range of short- and ultra-short wave components, among which will be found a 15 mc/s IF coil unit for ultra-short wave superheterodynes, for it is stated to have a frequency coverage of over a megacycle. It costs 5s. 9d. There are SW coils of every conceivable kind, valve holders on Frequentite, special chokes, and the like.

Two 450 kc/s IF transformers are shown, one being a variable selectivity type, the other being fitted with fixed coils giving a 10 kc/s band width. The former costs 9s. 6d. and the latter 8s.

Switches have always been a speciality of this firm, and many new models are now available. One of the most interesting is a four-pole five-way wave-change switch for use in all-wave sets.

An all-wave coil assembly is another new product; it covers a wave-range of 15 to 2,000 metres in four bands, and coil assemblies are available for aerial and oscillator circuits. The coils are fully screened but

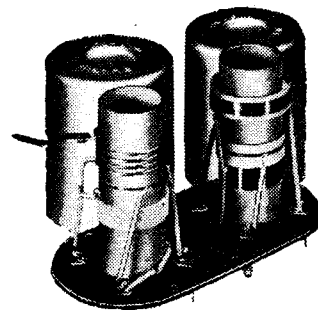

Compact four-range coil unit; a Bulgin product.

wave-change switches are omitted, it being recommended that the new 5-way switch be employed. The price of a complete set is 17s. 6d.

There is an extensive range of screened skeletonised coils, LF and HF chokes, some of the latter being designed especially for

Complete Show Report—

ultra-short wave use, and almost every conceivable type of resistance used in present-day sets.

Among the Bulgin test apparatus is an AC/DC watt-meter for measuring the power taken by mains receivers and radio-gramophones; its price is but 15s.

This must surely be one of the most comprehensive displays of components in the exhibition.

A. F. Bulgin & Co., Ltd., Abbey Road, Barking, Essex.

BURGOYNE (2)

Moderately priced sets, including portables, battery models and both universal and AC mains sets, comprise the Burgoyne exhibit. The latest introduction is the Dragon AC Superhet with three receiving valves; the IF amplifier operates at 473 kc/s, and variable tone control is provided.

An unconventional AC radio-gramophone, in the form of a compact table model embodying an HF-det.-LF circuit, costs only 11 guineas—surely approaching the low record for this class of instrument.

Universal sets with a straight HF-det.-LF circuit cost 7 guineas, or, with a "Droit-

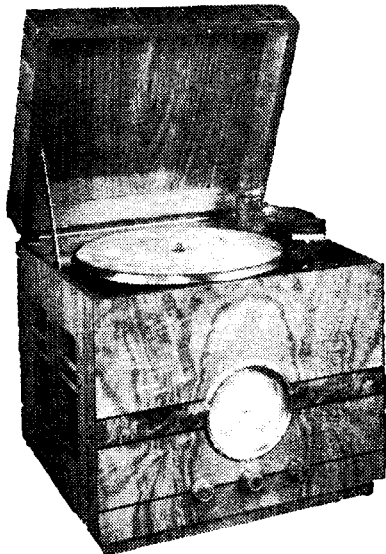

Burgoyne table-model radio-gramophone.

wich Filter," for use in the Midlands, 10s. 6d. extra. The cheapest mains set is the universal Moth at 6 guineas.

Burgoyne Wireless (1930), Ltd., Great West Road, Brentford, Middlesex.

BURNDEPT (61)

Three wave-ranges, including short waves between 17.5 and 51.5 metres, are offered at the low price of 18 Ss. in the new Burndept "all-wave" battery model, which employs an HF-det.-LF circuit. A universal AC-DC set with basically the same circuit costs 10 guineas.

Independent of an aerial and adaptable as to its supply current, the Universal superhet portable is a distinctly versatile set, fitted with a removable carrying handle. Both this receiver and its companion battery set work on self-contained frame aeri-als.

The Ethodyne, with twin loud speakers disposed to give improved diffusion of sound, is externally similar to last season's



Burndept all-wave receiver.

model, but includes a new type of superheterodyne chassis.

A series of Burndept HT batteries has just been introduced.

Burndept, Ltd., Light Gun Factory, Erith, Kent.

BURTON (105)

The exhibit of this firm comprises receivers for both batteries and mains operation, eliminators and trickle chargers, switches, coils, and lead-in tubes.

C. F. and H. Burton, Progress Works, Bernard Street, Walsall.

BUSH RADIO (85)

A feature of the new Bush AC-DC superheterodyne is the fitting of a permanent-magnet loud speaker in place of the more conventional energised type. It is claimed that this innovation has proved to be a distinct improvement; the load on the rectifier

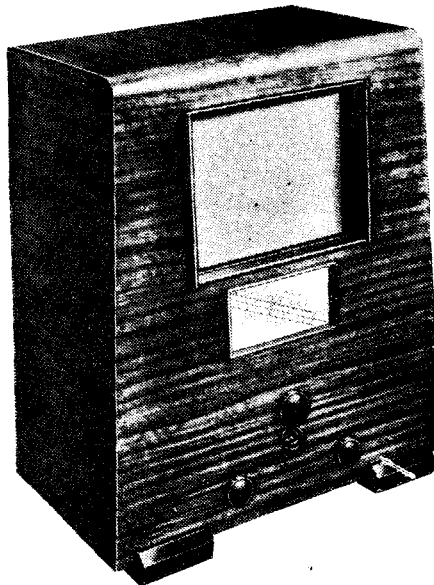

Bush universal superheterodyne.

is reduced, as no direct current is consumed for energising the magnet.

The "standard" Bush AC superhet for the present season is the SAC21, with an easily read diagonal scale. A similar set, which will interest those who prefer a triode output valve to the almost ubiquitous pen-

tode, is the SAC25, with an AC044 valve in the last stage.

Two battery superhets, with automatic bias, one having a Westector and the other a diode, are also shown.

Bush Radio, Ltd., Woodger Road, Shepherd's Bush, London, W.12.

C.A.C. (38)

The Austin AC Super-Six is a five-valve receiver, including QAVC, a separate triode valve being used to obtain the muting action. A triode-pentode frequency-changer is used with one IF stage, and a duo-diode-triode second detector and LF amplifier. The output is 3 watts from a pentode to dual loud speakers of the energised type. The Scanning Disc type dial is fitted. This dial is so arranged that the effective scale length is twice that normally obtained for the same panel opening.

The Austin AC Super-Seven is a radio-gramophone, for which specially high

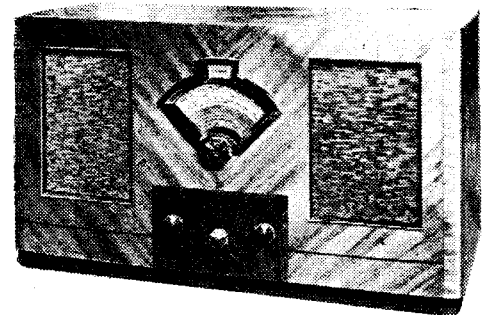

The C.A.C. Austin AC Super-Six.

quality reproduction is claimed. A push-pull output stage is employed, and the loud speaker is incorporated in a separate cabinet.

A smaller receiver, the Austin AC Super-Five, has dual-speakers and a pentode output valve. AVC is included and obtained with the aid of a duo-diode-triode. There is one IF stage following the frequency-changer. This set is priced at 15½ guineas, and there is a battery model at 14½ guineas having a similar circuit arrangement but fitted with a Class B output stage.

In addition to ordinary receivers there is the C.A.C. car radio equipment. A single unit construction is adopted and a high degree of sensitivity is claimed. The complete equipment, including the remote control apparatus, is listed at 24 guineas.

The Wireless World 1936 Monodial AC Super occupies a prominent position on the



C.A.C. Cabinet for the 1936 Monodial AC Super.

Complete Show Report—

stand, and a wide range of cabinets is shown, including one for this receiver.

City Accumulator Co., Ltd., 18-20, Norman's Buildings, Central Street, London, E.C.1.

C.A.V. (214)

The C.A.V. exhibit comprises primary and secondary batteries of all kinds. Prominence is given to the non-spillable jelly-electrolyte accumulators, of which many sizes and capacities are available.

In the C.A.V. series of HT batteries three capacities are available: Standard, Super, and Triple.

C. A. Vandervell, Ltd., Well Street, Birmingham.

CELESTION (26)

In addition to a wide range of loud speakers for set manufacturers a new series of extension loud speakers and chassis for sale to the public are being shown. The latter are handled by Cyril French, 29, High Street, Hampton Wick, Middlesex, who has been appointed sole distributor to the wholesale and retail trade. These new speakers incorporate an ingenious combined matching and volume control which is applicable to both high and low impedance outputs. The chassis are solidly constructed with cast aluminium bases, and three main types are available: the "Standard 8" at £2 5s., the "Senior 9" at £2 15s., and the "Junior Auditorium" at £6. Special attention has been given to the design of cabinet for these speakers in order that they will harmonise with the majority of furnishing schemes. The standard finish is in walnut, but oak or mahogany are available to special order. The prices of the cabinet

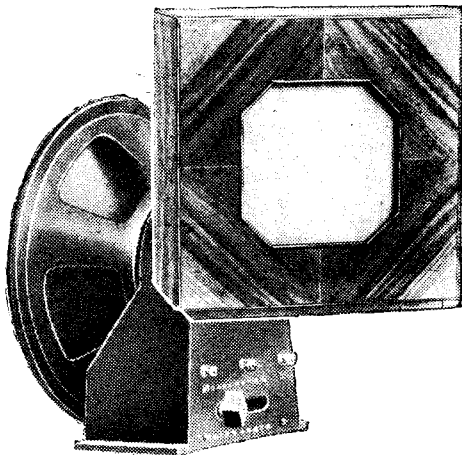

Celestion "Senior 9" extension loud speaker.

models in the order previously mentioned are £3, £4 10s., and £7 15s.

Other loud speakers in chassis form available to the general public include the "Junior 8" permanent magnet at 35s., "Junior Auditorium" energised at £4 15s., and the "Senior Auditorium" energised at 15 guineas for DC and 18 guineas for AC. All the permanent-magnet models in this range, incidentally, are fitted with the latest type of nickel aluminium alloy pot magnet.

Celestion, Ltd., London Road, Kingston-on-Thames, Surrey.

CENTRAL EQUIPMENT (3)

The No-Mast Brush Type Aerial is shown on this stand with the Siltit Chemical Ever

Moist earth. This is a device giving a large area of contact with the earth. A lightning switch is also shown, as is the range of R.A.P. receivers for which the firm acts as agents.

Central Equipment, Ltd., 188, London Road, Liverpool.

CLARKE'S "ATLAS" (83)

The tilted spectrum tuning dial which last year was fitted to some only of the Clarke Atlas receivers is being standardised in all the new season's models. This is station-calibrated, and when the set is switched on the medium-wave range station names appear in green. On turning the switch to the long-wave position these disappear and another set of station names appears in red.

The latest Atlas range includes radio-gramophones, console type receivers and table models. The model A39 comes within the first category, being a six-valve radio-gramophone giving an undistorted power output of six watts from two valves operated in push-pull. An up-to-date superheterodyne circuit is employed having seven tuned stages and with delayed and amplified AVC.

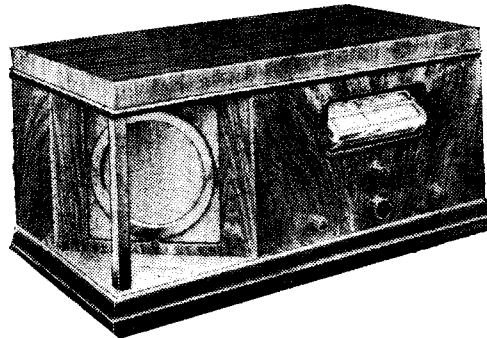

Clarke's Atlas 7.5.8. superheterodyne.

A Piezo-crystal pick-up and Garrard electric motor comprise the essential parts of the gramophone side. This model is, of course, AC operated and costs 39 guineas. The same chassis fitted in a handsome console cabinet costs 22 guineas.

A modified version of the six-valve chassis, but having a single triode giving 2½ watts output, is shown in the form of a five-valve radio-gramophone at 24 guineas, or in a console cabinet at 17 guineas.

There is an extensive range of table models, all of which show originality in design, not only of the cabinet work, but also in the electrical equipment. A fine example is the A.7.5.8. model, in which the loud speaker is mounted in one corner of the cabinet. These are popular-priced receivers. Atlas mains units are shown also.

H. Clarke and Co. (M/c), Ltd., Atlas Works, George Street, Patricroft, Manchester.

CLIMAX (22)

Technically speaking, the most impressive of the Climax receivers is the Model 534, covering four wave ranges, including two short-wave bands; 10-30 and 28-80 metres. It is, of course, a superheterodyne, and costs only 16 guineas.

The new TC III receiver is for AC operation, and includes a straight HF-det.-LF circuit with iron-cored tuning coils. Among other sets is the "Sports Model" battery superhet, with an up-to-date circuit employing four valves with pentode output; the

aim in the design of this set has been to give the battery user a performance com-

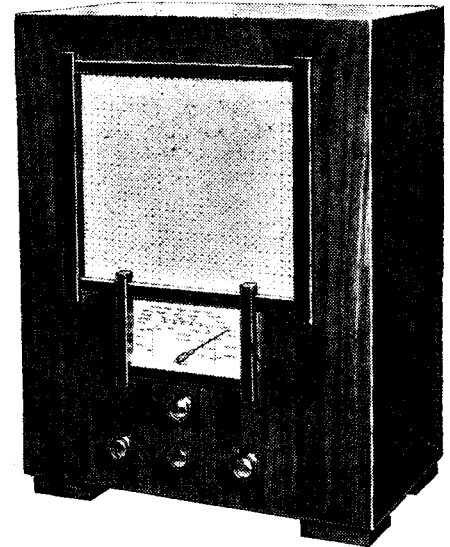

Climax battery receiver, Type MC36.

parable with that of the mains set within the natural limitations imposed in the matter of power output.

Climax Radio Electric, Ltd., Haverstock Works, Parkhill Road, London, N.W.3.

CLIX (115)

Two new short-wave valve-holders have been introduced into the Clix range of specialities. One is a chassis type with ceramic insulation, while the other is for baseboard mounting; the valve-holder in this style being supported on short pillars. Both types are available for 4-, 5-, 7- and 9-pin valves.

A voltage selector plate for mains sets is another very useful item, while battery users will find much to interest them in the long series of plugs, sockets and spade-end terminals, the latest addition to the last mentioned being a heavy-duty non-corrosive type costing 3d. each.

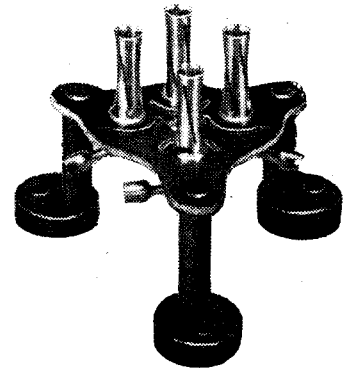

Clix short-wave baseboard valve-holder.

The well-known Clix chassis valve-holders in all their variety of forms are retained for the coming season.

Lectro Linx, Ltd., 79a, Rochester Row, London, S.W.1.

COLVERN (55)

To the already extensive range of Ferrocart coil units has been added several new models for use in superheterodyne receivers, the oscillator coils being designed for the latest types of frequency-changers now available. Two units, each of three

Complete Show Report—

coils, are included for use with 465 kc/s IF amplifiers, one has a pair of band-pass coils, whilst the other would be employed if an HF stage precedes the frequency changer.

The series of complete tuning units, each comprising coils and a gang condenser mounted on a metal chassis, has also been augmented, there being some seven new models in all, and of these two are for 465 kc/s IF amplifiers.

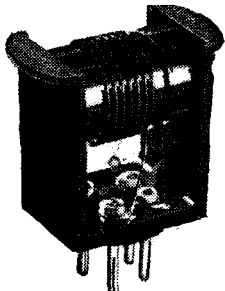

The new Colvern short-wave coils are fitted in a cradle-type carrier to ensure short low-capacity leads.

There is a new Ferrocart IF transformer for the higher frequency already mentioned, and one for ultra-short-wave receivers. Some additions have been made also to the air cored series of coils.

The new short-wave coils are designed to have the lowest possible self-capacity, spaced windings on a horizontal former and short straight leads to the base plug being features of this design. Three coils cover a waveband of 14 to 100 metres, and they cost 4s. 6d. each.

This year Colvern are showing a range of short-wave variable condensers embodying several interesting features.

Colvern, Ltd., Mawneys Road, Romford, Essex.

CONCORDIA (218)

This stand is devoted to a display of wire of all types. Tinned copper and insulated wires are prominent, while Litz wires and flexible types are represented, and there are also the R.W. Aerial and spaghetti type resistances.

Concordia Electric Wire Co., New Sawley, near Nottingham.

COSMOCORD (221)

Auxiliary gramophone equipment is the speciality of this firm, and the exhibit consists of gramophone pick-ups, motor units, and playing desks for the conversion of table model receivers into radio-gramophones. The specification of the Model 996 playing desk includes an AC motor with automatic stop and speed control, and the pick-up is

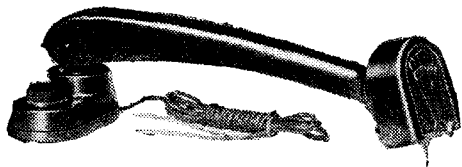

Cosmocord Model 15 pick-up.

provided with a volume control. The price is £4 19s. 6d. A smaller model, from which the automatic stop is omitted, known as the "Unigram," is available at £3 9s. 6d., while the Model 168 pedestal playing desk incorporating the Model 996 motor unit and with ample space for record storage costs 8 guineas. A motor unit including pick-up and volume control is available separately at £2 15s.

There are three gramophone pick-ups. The De Luxe model with an average output of 1 volt costs 21s., and the Model 15 with an output of $\frac{1}{2}$ volt, 15s. Both these models include volume control, pick-up rest, and connecting leads, while in the case of the De Luxe model a needle cup is incorporated in the pick-up rest. Finally, there is the Model 10 designed for attachment to existing tone arms and priced at 15s.

Cosmocord, Ltd., Cambridge Arterial Road, Enfield, Middlesex.

COSSOR (70)

A wide range of receivers of various types is shown by this firm. The Super-Ferrodyne series comprises three battery table-models. In each there is a single HF stage with a pentode detector and iron-core coils are used. The Model 360 has a triode output valve, a moving-iron loud speaker, and is priced at £5 15s., whereas the Model 363 has a pentode output valve and an MC speaker; it is listed

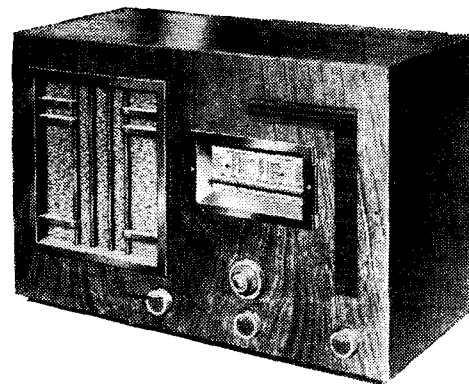

Coszor Model 363 receiver.

of course, the Coszor Neon Tuning Indicator.

A. C. Coszor, Ltd., Coszor House, High-bury Grove, London, N.5.

CRYPTO (215)

This exhibit is representative of an amalgamation of the battery-charging interests of Lancashire Dynamo, Crypto, and Rotax. Equipment of all types for charging batteries, mainly on a commercial scale, is shown, but there is at least one model (the Rotax Minor) which is of interest to the private user. This charger deals with batteries between 2 and 12 volts, the rate being automatically maintained at $1\frac{1}{2}$ to 2 amps. Rectification is by a valve, and control by a barretter.

Oxide cathode and mechanical commutating rectifiers are used in the large plants; engine-driven chargers are also manufactured.

Crypto Equipment Co., Acton Lane, Willesden, London, N.W.10.

CYLDON (118)

High-grade precision variable air-condensers designed especially for use in laboratory and test apparatus constitute one of the principal features of this firm's exhibit. They are of the straight-line capacity type insulated throughout with Mycalex. These special condensers, as they are known, are made in all standard sizes; a 0.0005 mfd. model costs £1 17s. 6d.

Cyldon has a new series of transmitting air-spaced condensers rated at 2,000 volts, 3,000 volts, and 5,000 volts respectively; some are plain type, while others have split stators. A 0.0001 mfd. in the 2,000-volt style costs £1 15s., whilst a 0.0002 mfd. for 3,000 volts' working is priced at £2 5s.

Other items of interest include some air-dielectric trimmers in single and dual pattern up to 100 m-mfd. in size, fixed air condensers and mica-type trimmers.

Sydney S. Bird and Sons, Ltd. (Cyldon Radio), Cambridge Arterial Road, Enfield, Middlesex.

DAGENITE (94)

Radio accumulators of every type are shown on this stand, and the firm specialise in supplying replacement cells for all well-known sets. In addition to the free-acid types in both glass and celluloid containers there are jelly-acid cells for portables.

Peto and Radford, 50, Grosvenor Gardens, London, S.W.1.

DARWINS (107)

The latest nickel-aluminium and nickel-aluminium-cobalt alloy magnets are the

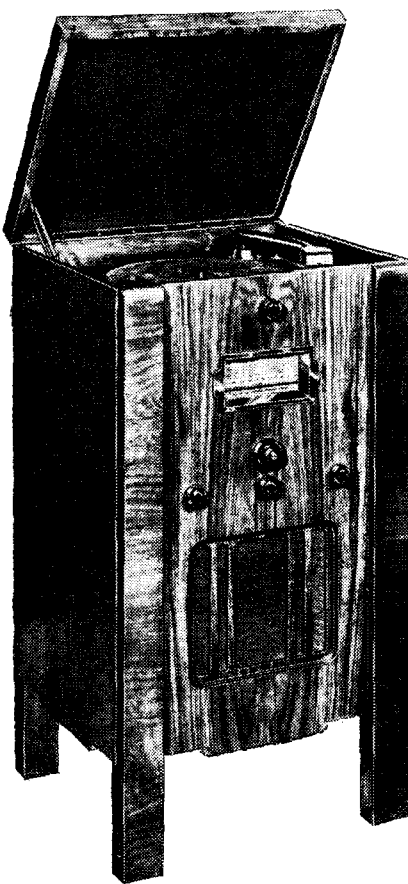

The Coszor Model 536 radio-gramophone.

at £6 15s. The Model 436B has a Class "B" output stage. There are several mains sets in this series including a radio-gramophone, Model 536, at 16 guineas. The receiver chassis is of the HF-det-pen type. The Universal AC/DC set, Model 369, is unusual in that a triode output valve is employed.

Superheterodynes are also shown, and in the Model 364 a heptode frequency-changer is used with one IF stage, a duo-diode detector and AVC valve, and a pentode output stage. A neon tuning indicator is fitted. The set is priced at 11 guineas, and a battery model with a similar circuit arrangement is listed at 9 guineas.

In addition to receivers this firm is showing its comprehensive range of valves including not only battery and AC mains types, but Universal AC/DC models, and,

Complete Show Report—

centre of interest in the exhibit on this stand, which also includes a wide range of standard types manufactured from cobalt steels. Instruments showing the applications of permanent magnets to microphones, gramophone pick-ups, etc., are also shown.

Darwins, Ltd., Fitzwilliam Works, Sheffield.

DAVENSET (104)

The principal exhibit here is a series of mains transformers and smoothing chokes. All the transformers have screened windings; mechanically, the designs are ingenious, as the windings are completely protected and concealed by a bakelite moulded top. A number of special output transformers and chokes are also shown.

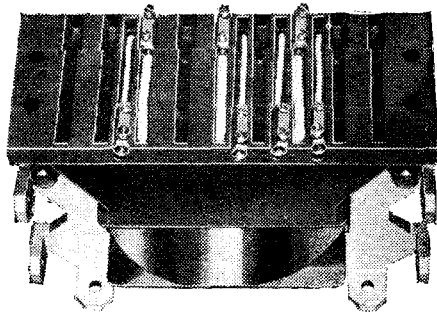

Davenset shell-type transformer (terminal panel removed.)

Davenset battery chargers, with valve rectification, now include positive protection against overload, and such refinements as automatic time switches are now available. The rectifying valves are guaranteed for two years.

Partridge, Wilson & Co., Ltd., Evington Valley Road, Leicester.

DECCA (34)

This firm's association with the manufacture of portable gramophones is further established by the inclusion in this year's exhibit of an all-electric portable radio-gramophone. This model, which is of the suitcase type, is known as the "Portrola" and is available in AC or universal form at 12 guineas. The chassis is of unit construction, and the base plate incorporates an inclined speaker board. The up-to-date superheterodyne circuit includes a triode-pentode frequency-changer, variable-mu IF amplifier, and double-diode-pentode output valve.

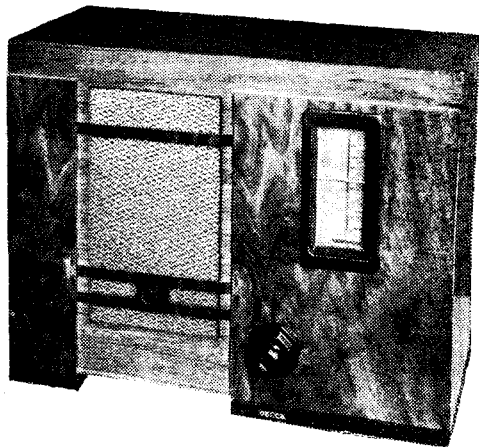

Decca 5-valve (including rect.) superheterodyne receiver.

First from the point of view of technical interest among the radio receivers shown by this company must be placed the combined home and car radio set, which can be operated alternatively from the car battery or AC mains. A self-contained rotary converter supplies the HT current when the set is run from the car battery, yet the overall dimensions of the set are only 15½ × 13 × 7¾ in. The "Rally" model with a three-valve superheterodyne circuit similar to that used in the "Portrola" costs 15 guineas, and the "De Luxe," with a signal-frequency HF stage and a separate double-diode-triode second detector is 18 guineas.

These two chassis are also available as table model superheterodynes of the normal type, the price being £9 19s. 6d. and 11 guineas respectively for AC mains, and 10 guineas and 11½ guineas for universal AC/DC mains. The higher-priced model, incidentally, is fitted with inter-station noise suppression in addition to AVC, and is available also as a radio-gramophone at 19 guineas for the AC model and 20 guineas for the universal.

The Decca programme is completed by a five-valve all-wave receiver at 16 guineas in table model form and 24 guineas as a radio-gramophone. The circuit consists of a signal-frequency HF amplifier, triode-hexode frequency-changer, two variable-mu IF amplifiers, double-diode detector and

simultaneously one 120-volt HT battery and three banks each of eleven 2-volt LT cells at currents of 1, 3, and 5 amps. respectively. Each circuit has its own rheostat control and meter, and the price of the complete equipment, including starter switch and cut-outs, is £33.

Alfred Diggle and Co., Jane Street, Rochdale, Lancs.

DYNATRON (32)

With the exception of the short-wave apparatus, the receivers shown by this firm are all straight sets. They are essentially high quality sets, and the Ether-Emperor has no fewer than seventeen valves. Three HF stages are used with triple band-pass filters and variable selectivity; QAVC is fitted, and six valves are used in the LF amplifier, which gives an output of 12 watts. Short-wave reception is provided by means of a SW converter which has three tuned circuits. Smaller straight sets are shown, but all incorporate the same basic features of band-pass filters and iron-core coils, together with a neon tuning dial in which neon tuning indicators act not only to show when resonance with a station has been reached, but also to indicate the dial setting.

H. Hacker and Sons, Perfecta Works, Ray Lea Road, Maidenhead, Berks.

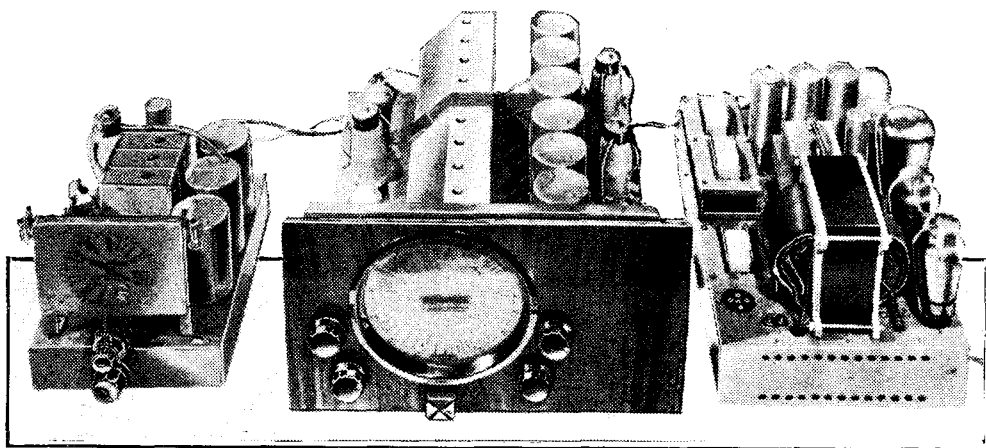

Chassis of the Dynatron all-wave receiver.

pentode output valve. Both models are fitted with AVC, and the radio-gramophone, which employs a double-diode-triode in the second detector stage, also includes inter-station noise suppression.

Decca Gramophone Co., 1-3, Brixton Road, London, S.W.9.

DE LA RUE (5)

This stand is devoted to a display of a wide range of mouldings in Bakelite, Urea, Cellulose Acetate, and other synthetic resins. The mouldings shown include such large examples as cabinets for wireless receivers.

Thos. De La Rue and Co., Ltd., 90, Shernhall Street, London, E.17.

DIGGLE (16)

This firm specialises in the manufacture of battery-charging plant of the motor-generator type. There is a wide range of machines of various specifications, and prices range from £25 to £105. The Type 1A is representative of those machines which have been designed specially for wireless service stations. It is capable of charging

DUBILIER (67)

Dubilier has introduced several new series of condensers for the coming season. The tubular models have been redesigned, but the physical dimensions remain ostensibly the same as hitherto. The working and test voltages are as formerly, viz., 400 and 1,000 DC respectively. The capacities made are from 0.001 mfd. to 0.5 mfd., the prices being 1s. to 2s. according to size. Mica condensers are now available for 1,000 volts DC working in the B770 type. They include capacities of 0.0001 mfd. up to 0.01 mfd. and cost from 7s. to 10s. each.

Several of the metal-cased condensers have been withdrawn, but the types BS, 250 volts working, LSA, 400 volts working, the LEG and LSG, 650 and 900 volts DC working respectively, remain as hitherto, so do the several different styles of high voltage dry electrolytic models.

There is a new series of oil-immersed paper dielectric condensers in hermetically sealed metal containers which are made for working voltages as high as 4,000 DC. Prices vary according to size and type;

Complete Show Report—

for instance, a 2-mfd. 1,000-volt model costs 13s., while the same capacity for 2,000 volts working costs 17s. 6d.

The full range of metallised resistances, Spir-ohms, small mica condensers, and a series of new volume controls are available for examination.

Dubilier Condenser Co. (1925), Ltd., Ducou Works, Victoria Road, North Acton, London, W.3.

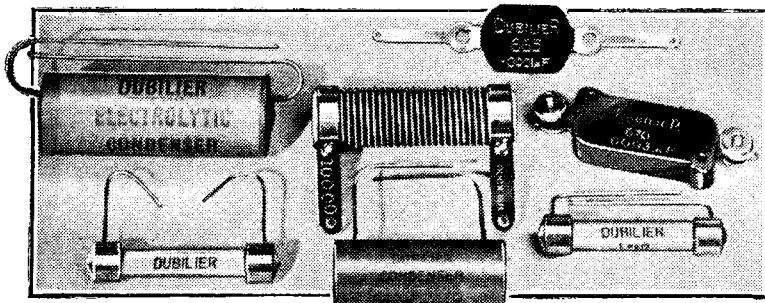

Selection of Dubilier products.

EDDYSTONE (30)

The designers of Eddystone short-wave components can always be relied on to produce some new and interesting parts at this time of the year. The latest developments shown include a range of low-loss short- and ultra-short-wave coils, HF chokes in a variety of types, valve-holders, and a new 400/500 kc/s IF transformer with Litz-wound coils and air-dielectric trimmers which costs 13s. 6d.

An overseas model short-wave receiver in full tropical finish is shown, also a new six-valve superheterodyne covering 13.5 to 550 metres in four bands. It is AC operated and costs £33.

There is a new four-valve straight receiver, the "Quadradyne," housed in a welded steel cabinet. This should appeal to short-wave listeners requiring a sensitive set at a reasonable price.

Among the new components is a welded steel cabinet in two sizes, the larger costing 25s., and a three-unit, two-stage ultra-short wave IF unit assembled in a die-cast box. Its price is 25s. 6d. There is a short-wave wavemeter at 63s., a new series of dials,

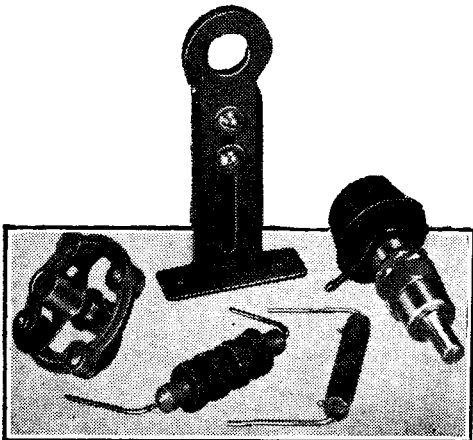

Some of Eddystone's new season's components.

telescopic self-supporting 5-metre aerials, and a host of other items that will interest the experimenter in the fields of short- and ultra-short-wave reception.

Stratton and Co., Ltd., Eddystone Works, Bromsgrove Street, Birmingham.

EDISWAN (79)

Mazda valves constitute the greater part of the exhibit on this stand. Recent additions to the range include a double-diode-pentode at 21s., designed for universal sets. This

valve, the DD4020, has a 40-volt heater and is designed to withstand the wide variations in voltage that are frequently met with in universal sets. Another interesting valve

is the ES60, a power amplifier with a hard glass bulb and a graphite anode designed to dissipate 60 watts. The filament takes 4 amps at 6 volts, and the maximum HT voltage is 750. The price is £5 10s.

Pick-ups are another important feature of this stand, and the new B.T.H. "Pēzolectric" pick-up is creating considerable interest. It has an average voltage output of the order of 2 volts and is fitted in a tone arm giving 97 per cent. perfect tracking. The price is 42s.

The B.T.H. Needle Armature and Minor pick-ups are being continued, and other interesting items making up this exhibit are



Ediswan "Pēzolectric" pick-up.

the RK loud-speaker units, Tungar battery chargers, and Ediswan cathode-ray oscillograph.

Edison Swan Electric Co., Ltd., 155, Charing Cross Road, London, W.C.2.

EELEX (T9)

In addition to a range of proprietary goods, this firm of wholesalers is showing the Eelex short-wave converters. The Duplex model is of the single-valve type and is suitable for battery, AC, or DC receivers. It covers 15/60 metres and costs 52s. 6d. The B2 converter is a two-valve model covering the same tuning range; it is designed for battery operation and is priced at £4. The M2 AC mains model is listed at £7. The exhibit is completed by a display of terminals, testing prods, and a special safety switch.

J. J. Eastick and Sons, 118, Bunhill Row, London, E.C.1.

EKCO (76)

With the exception of the radio-gramophone, all the sets in the Ekco range are housed in moulded bakelite cabinets of original design. In the Model AC86 at 12½ guineas the loud-speaker fret is balanced by the large-diameter combined tuning scale and control panel, which gives a pleasing symmetrical design. The circuit consists of an octode frequency-changer, HF pentode, double-diode-triode and pentode output valve, and in the B86 battery equivalent at 11½ guineas the circuit is similar, but a triode-pentode is used in the

frequency-changer stage, and a QPP valve in the output.

The RG86 at 22 guineas is fitted with the same chassis as the AC86, and the sides of the cabinet are cut away to reduce cabinet resonance and give "three-way sound diffusion."

In the circular AC76 set at 11 guineas an octode frequency-changer is followed by an HF pentode, double-diode-detector, and high-slope pentode output valve. The universal mains equivalent, Model AD76, is priced at 11½ guineas.



Ekco Model RG86 radio-gramophone.

The Model ACT96 is an AC mains transportable having a circuit similar to the AC86 but with an additional signal frequency HF stage. The chassis construction is unusual, being of the double-decker type with the power pack separate from the receiver unit. The price is 14½ guineas.

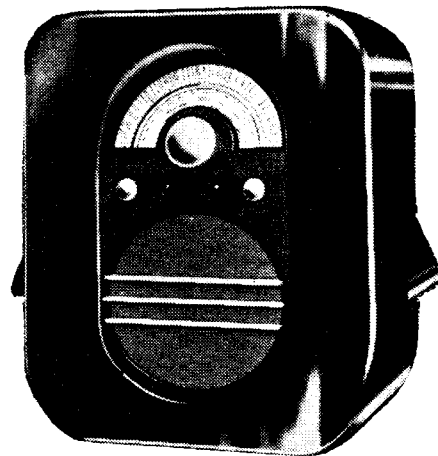

Ekco Model ACT96 mains transportable.

The range of broadcast sets is completed by a "straight" universal set, the Model AD36, at 8 guineas.

Last but not least there is the Ekco Car Radio at 20 guineas, with an AVC superhet circuit designed for 6- or 12-volt equipments. It fits into the fascia board and has a direct tuning drive with a non-dazzle illuminated scale.

E. K. Cole, Ltd., Ekco Works, Southend-on-Sea, Essex.

ELECTRICO (114)

Table stands to accommodate any of the

Complete Show Report—

more popular types of receivers are shown by this firm. The stands are finished to match the set for which they are designed, and range from the simplest possible designs to quite elaborate book-case patterns. Grooves are provided in the rear legs in order that the connecting wires may be neatly concealed.

Electrico (Croydon), Ltd., 97, George Street, Croydon, Surrey.

ELECTRO DYNAMIC (112)

This firm is showing small rotary converters in a variety of types and sizes. Special interest attaches to the DC to AC machines, since these are widely used for operating AC sets from DC mains.

There is now an extensive series of self-contained petrol-driven alternators for supplying AC power to public address apparatus, these sets being available from 180-watt to 1,000-watt rating. The former cost £39 and the latter £72.

A 12-watt rotary transformer assembled in a watertight container for obtaining HT from an LT battery is available for car radio sets, one model giving 250 volts at 50 mA costs £4 6s. complete, which includes a filter.

Electro Dynamic Construction Co., Ltd., Devonshire Grove, London, S.E.15.

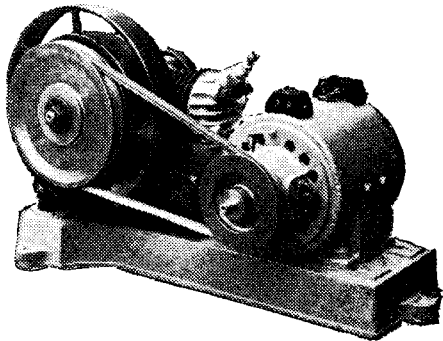

Petrol-driven alternator made by the Electro Dynamic Co.

ELECTRON (39)

Superial aerial wire, in its latest form, embodies a screened lead-in section for the suppression of interference. It is supplied in roof. coils, of which 20ft. is covered with a braiding of tinned copper wire. Other aerial wires and fittings are also exhibited.

New London Electron Works, Ltd., East Ham, London, E.6.

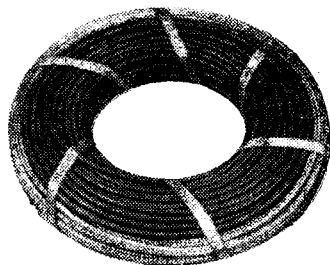

Electron aerial with screened download.

EMPIRIC (41)

Really small but practical receivers are at last beginning to appear on the market, but none can rival the Empiric Pocket Set in the matter of compactness. Its descriptive title needs no licence, as the bakelite container in which the apparatus is housed measures only 6in. by 4½in. by 1½in.—no larger than a so-called "pocket edition"

book; its weight is under 2lb. and the price £4 10s.

The set is entirely self-contained with its built-in frame aerial, and employs two Hivac midget valves in a self-quenching super-regenerative circuit. A range of seventy miles is claimed. This set operates with a single earphone; a slightly larger model, about the size of the popular box camera, has double headphones.

The third miniature set is a loud speaker model measuring 7¼in. by 7¼in. by 5½in., with three Hivac midget valves and a standard PP220 in the output stage of an

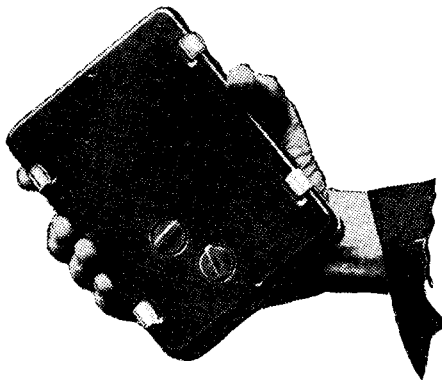

Empiric Pocket Receiver.

HF-det.-LF circuit. Weight is 6¼lb., of which the 75-volt HT battery accounts for a good proportion.

Empiric, Ltd., 51, Calthorpe Street, London, W.C.1.



Two Empiric miniature sets.

EPOCH (47)

Many of the quality and public address loud speakers for which this firm is known are being continued, but the exhibit includes several important new lines. In the first place, the Type 20C loud speaker at £1 15s. has been redesigned and is now fitted with a nickel-aluminium alloy magnet. The normal speech coil impedance is 7½ ohms, but special coils down to 1 ohm can be supplied to match the output from certain sets on the market. A cabinet suitable for this loud speaker is available at 12s. 6d.

The "New 66" at £4 12s. 6d. is a quality reproducer built on the lines of the Epoch "Domino." The field can be supplied for 6- or 12-volt batteries or for DC mains excitation. There is also a model suitable for immediate connection to either AC or DC mains at £6 12s. 6d.

Another interesting exhibit on this stand is the new Type 55 moving-coil microphone.

It is fitted with a magnet having a total flux of over 20,000 lines, and the frequency

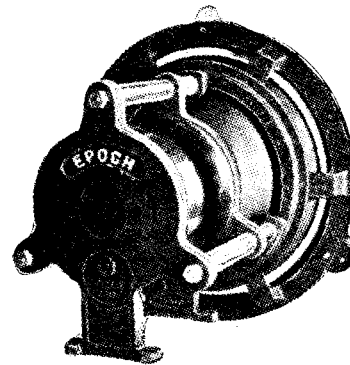

Epoch "New 66" loud speaker.

response is from 72 to 5,000 cycles. The price is 5 guineas, or 6 guineas with folding floor stand, and a suitable pre-amplifier for battery operation costs 2 guineas complete with special input transformer.

Epoch Reproducers, Ltd., Aldwych House, Aldwych, London, W.C.2.

ERIE (15)

The most recent addition to the Erie range of resistors is a midget insulated model described as the type 4N. This is rated at ½ watt, and the resistance element is totally enclosed in a porcelain sleeve. In view of the small space occupied by the resistor, and the fact that it is fully insulated, renders it especially suitable for fitting into the cans of screened coils.

Wire-wound heavy-duty resistors from 5 to 100 watts rating are available, together with a series of volume controls up to one megohm in value with and without built-in switches.

Erie Resistor, Ltd., Carlisle Road, Hendon, London, N.W.9.

EVER READY (71)

In addition to its well-known range of batteries, this firm is showing a number of receivers. The Model 5002 is an AC set with a band-pass input circuit feeding an octode frequency-changer. One IF stage is used and there is a duo-diode output pentode which provides AVC. A battery set of similar design has Westectors for detection and AVC, and a Class "B" output stage; this is the Model 5001. Both

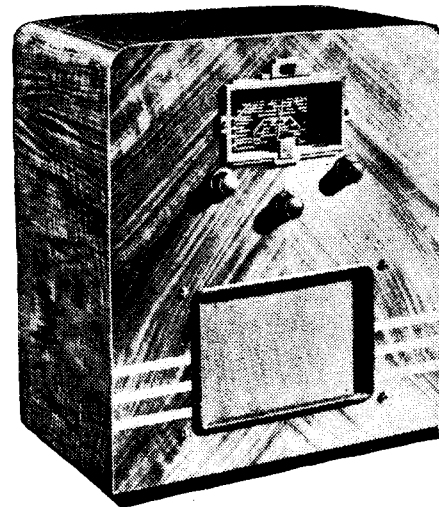

The Ever-Ready 5001 battery receiver.

Complete Show Report—

sets are priced at 12 guineas. The Model 5011 is an all-wave set for AC operation which includes variable selectivity, and in this there is a signal-frequency amplifier which is operative only on short waves. A duo-diode-triode is used for detection and

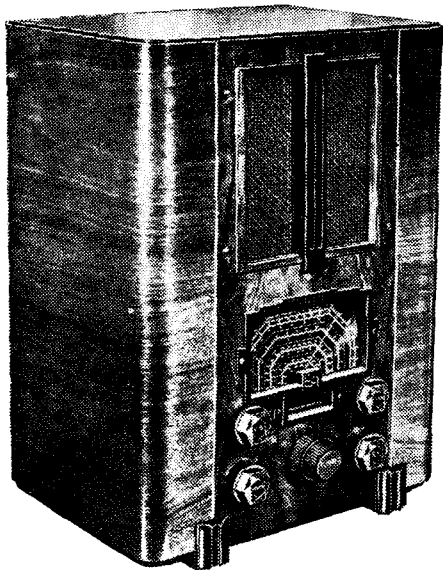

The Ever-Ready 5011 all-wave set.

AVC. Many other superheterodynes and straight sets for mains and battery working are shown, including radio-gramophone models.

Ever Ready Co. (Great Britain), Ltd., Hercules Place, Holloway, London, N.7.

EXIDE & DRYDEX (59)

The Drydex series of dry batteries has been still further extended, and there are now no fewer than 140 different types.

Among the Exide LT cells, the most interesting is probably the ironclad type, with strengthened positive plates and an improved form of built-in charge indicator.

Chloride Electrical Storage Co., Ltd., Clifton Junction, near Manchester.

FERRANTI (74)

The major portion of the Ferranti exhibit is this year devoted to complete receiving sets, of which there are five main types.

The "Una" sets are three-valve HF-det.-LF receivers with 2½-watt pentode

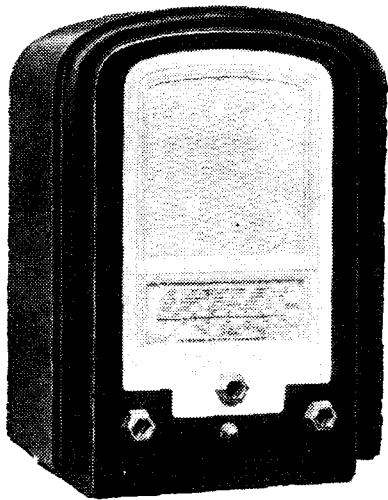

Ferranti "Nova" superheterodyne.

output valves. AC and universal types are available, both at 8½ guineas.

An entirely new bakelite cabinet has been introduced to house the "Nova" AC and universal consolettes, the prices of which are 11 guineas and 11½ guineas respectively. A three-valve AVC superhet. circuit with a heptode frequency-changer, variable-mu pentode IF and double-diode-pentode output valve is employed, and the cabinet may be obtained with a black or walnut brown body and ivory inlay.

The "Lancastria" sets have similar circuits to the "Nova," with the addition of a tuning indicator and noise-suppressor control. They are housed in walnut and macassar ebony veneer cabinets, and the prices are 12½ guineas for the AC and 13½ guineas for the universal models.

The "Arcadia" circuit is, in the early stages, similar to the "Lancastria," but separate detector and output valves are used, the latter being a 2½-watt triode. It is available as a table-model receiver at 15 guineas, as a console at 18 guineas, and as a radio-gramophone at 26 guineas.

The "Gloria" radio-gramophone incorporating a 6-watt push-pull output stage completes the range. The price of this instrument is 45 guineas, or 52 guineas with automatic record-changer.

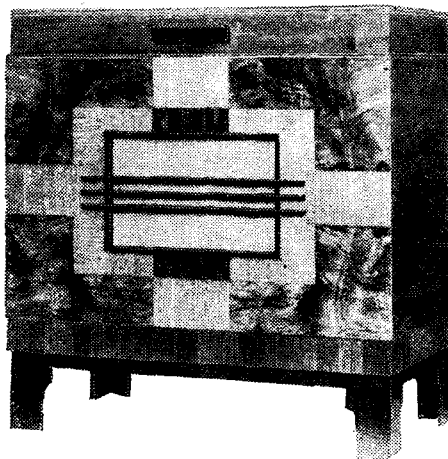

Ferranti "Gloria" radio-gramophone.

The requirements of the constructor are catered for by a wide range of components, which includes valves, meters, transformers and fixed condensers. There are also some interesting kits of parts for transformer-coupled amplifiers, and the 6½- and 12½-watt types are notable for the fact that the overall characteristic, including the output transformer, is flat within ½ db. from 25 to 10,000 cycles, and within 2 db. to 12,000 cycles.

Ferranti, Ltd., Radio Works, Moston, Manchester 10.

FULLER (119)

The Fuller range of HT batteries has been extended to include a new Super series and a range of special replacement batteries for portable receivers.

A new unspillable LT cell has been introduced having a capacity of 27 amp. hours and a strongly made carrier of new design is now being fitted to all the Standard Plate range.

Fuller Accumulator Co. (1926), Ltd., Woodland Works, Chadwell Heath, Essex.

FILM INDUSTRIES (4)

A new moving-coil microphone, Model M3, has been introduced for high-fidelity

work in connection with band relaying. It is similar in construction to the existing M2, but has an increased output and a wider frequency response. The price is 10 guineas. The horn-type loud speakers shown on this stand include the LS5 and

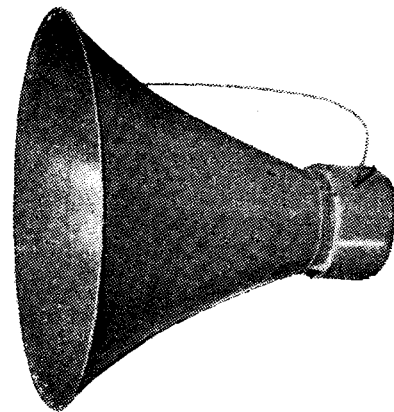

Film Industries PAC4 speaker and flare.

the LS6 models, with all-metal horns and permanent-magnet moving-coil units and a directional baffle model incorporating the PAC3 domestic cone unit. A radio relay receiver suitable for hospital or hotel use and a range of portable amplifiers are also items of interest on this stand.

Film Industries, Ltd., 60, Paddington Street, London, W.1.

G.E.C. (35, 44 & 63)

The receivers shown by this firm cover a wide range of types. The AC Mains 4 has one HF stage and a screen-grid detector with two low-loss tuned circuits. The output is 2½ watts and it is priced at 9 guineas. The Battery SG 3 has a similar circuit arrangement and is listed at £7 19s. 6d. The Superhet AC 4 has only three receiving valves arranged as frequency-changer, IF amplifier, and duo-diode output pentode. The intermediate frequency is 125 kc/s, and the set is priced at 11 guineas. An AC/DC model is avail-

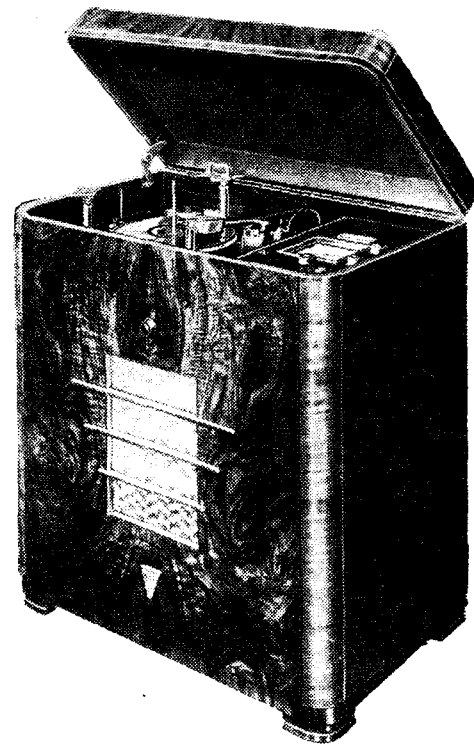

G.E.C. Fidelity Radiogram 5.

Complete Show Report—

able at 11½ guineas, and in this a barretter is used for regulating the heater current of the valves. The Fidelity AC 5 has an input band-pass filter to the heptode frequency-changer. A duo-diode-triode is employed for the detector and AVC supply, and it is resistance-coupled to the pentode output valve. As a table model it is listed at 13½ guineas.

A car-radio set is on view in which five valves are used. There are a signal-frequency amplifier, a heptode frequency-changer, one IF stage, a duo-diode-triode for detection, AVC, and LF amplification, and a pentode output stage. A single unit construction is adopted, with a separate remote-control panel, and the complete apparatus, including interference suppressors, costs 19 guineas.

The range of Osram valves occupies a prominent position on the stand, and all current receiving types are represented. The new X41 and X31 triode-hexodes for AC and AC/DC sets are of particular interest, for it is claimed that their use greatly reduces interaction between signal and oscillator circuits. A wide range of output pentodes and triodes is shown as well as multiple types including an HF pentode-duo-diode, a duo-diode-triode, and a duo-diode output pentode. In addition there are several special purpose valves among which the A537 is an important addition. It is a triode with Steatite insulation and a very low noise level for use in microphone amplifiers.



The Osram X41 triode-hexode.

The exhibit is completed by a range of HT and GB batteries.

General Electric Co., Ltd., Magnet House, Kingsway, London, W.C.2.

GARRARD (57)

Gramophone turntable motors are the speciality of this firm, and the Garrard automatic record-changer unit is again one of the principal exhibits. This machine plays eight 10-inch or 12-inch records, and is fitted with an automatic stop and reject control. The price, including pick-up, is £10 for the AC model and £10 17s. 6d. for the universal model.

The Garrard pick-up at 37s. 6d., or 32s. 6d. without volume control, is obtainable separately. This pick-up is also included in a wide range of "Radiogram" units of both spring and electric types, consisting of a motor and pick-up mounted on a metal base-plate and fitted with volume control and needle cups.

Garrard Engineering and Manufacturing Co., Ltd., Newcastle Street, Swindon, Wilts.

GOODMANS (51)

The "Auditorium" 12-watt permanent-magnet moving-coil loud speaker at 8 guineas, designed for light public address

work and employing a specially developed nickel-aluminium alloy magnet, and the new Goodmans "Grille" extension loud speaker at 4 guineas, with volume control and universal transformer, are the principal exhibits. The latter incorporates the Goodmans constant-impedance volume control,

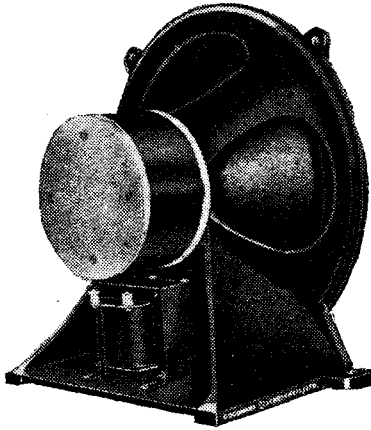

Goodmans Auditorium 12-watt speaker.

which employs a special method of winding to ensure freedom from breakdown and to compensate for apparent loss of bass at low volume.

The PM9 speaker at 3 guineas, the "Standard" extension speaker at 50s., and the Goodmans PA24 public address horn loud speaker at £10, are other products which justify a visit to this stand.

Goodmans (Clerkenwell), Ltd., Broad Yard Works, Turnmill Street, London, E.C.1.

GRAHAM FARISH & FORMO (64)

Occupying a prominent place on this stand is a new kit set described as the "Sensity Super." It employs a three-valve circuit having one HF stage. Iron-cored coils are

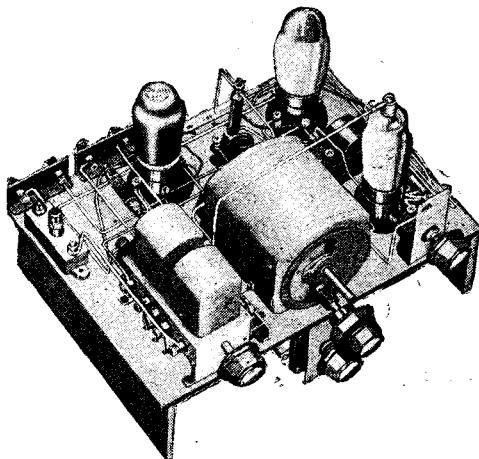

Graham Farish "Sensity Super" kit set.

used. It is a striking example of the fulness of the range of components made by this firm and the associated company Formo, for no other make is included in the kit, which costs 50s. without valves and batteries.

Among the new components added to the Graham Farish range is a chassis-type valve holder assembled on Frequentite, also a short-wave model for baseboard mounting and with the same insulating material. They cost 9d. for the 4-pin and 1s. for the 5-pin model in either form

A gramophone pick-up and tone-arm is available at 14s. 6d., or, fitted with a volume control as part of the assembly, at 18s. 6d. Other items of interest include LF transformers for parallel-feed, direct connection, QPP and Class "B," also resistances, condensers, and numerous other parts.

A special feature is made of short-wave components in the new season's Formo programme. There is a short-wave condenser of 0.00016 mfd. mounted on a Frequentite base, and having the rotor spindle insulated with the same material. This costs 3s. 6d. only. A series of short-wave plug-in coils on Frequentite formers covering a wave-band of 12 to 102 metres with three coils is available, also a coil stand holding two coils and incorporating waveband switching. The coils cost 3s. 6d. each, and the stand 2s. 6d. A stand for one coil costs 1s.

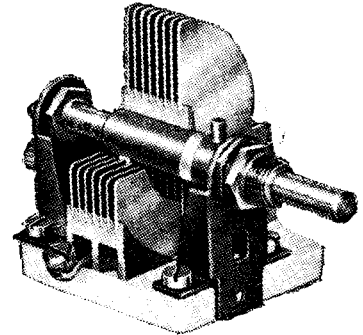

Steatite insulated Formo short-wave condenser.

There is a range of screened iron-cored coils shown in single units also assembled on a sub-panel with integral switching, and with which is ganged a mains, or radio-gramophone, switch. Single switched units cost 8s. 6d., and dual assemblies 12s. 6d.

Pre-set condensers, one-watt resistors, a dual-ratio condenser drive, also single and ganged condensers comprise some of the items that fully justify close examination.

Graham Farish, Ltd., 153, Mason's Hill, Bromley, Kent.

Formo Products, Ltd., 153, Mason's Hill, Bromley, Kent.

GRAMPIAN (111)

Among a wide range of moving-coil loud speakers designed for use in extension units and for incorporation in sets, the new "Pantone" unit is of outstanding interest. It employs a nickel-aluminium alloy magnet, and the cone is of composite construction reinforced with black linen. The main cone is reinforced by one of smaller size, and it is claimed that the combination gives a wider frequency response and better

Grampian "Pantone" loud speaker, with reinforced composite cone.

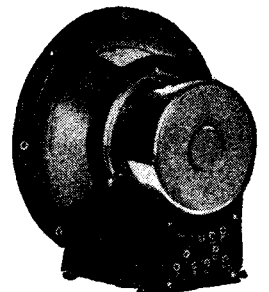

attack. The price of this new model is 42s. Incidentally, every permanent-magnet loud speaker manufactured by this firm is now fitted with the new nickel-aluminium alloy magnet.

Another speciality of this firm is light

Complete Show Report—

portable public address equipment for use in conjunction with dance bands, etc.

Gramplan Reproducers, Ltd., Station Avenue, Kew Gardens, Surrey.

H.M.V. (77 & 82)

From every point of view the "High Fidelity Autoradiogram" Model 800 is the outstanding H.M.V. exhibit. This 15-valve radio-gramophone, designed irrespective of cost, includes almost every refinement; a four-position variable-selectivity control, giving optional frequency responses of 3, 5, 7 or 8 kc/s, is perhaps its most valuable feature, but the contrast amplification system for correcting deficiencies in control in broadcasting or of recording in gramophone records will be at least as greatly appreciated by the quality enthusiast whose aim is realism.

Not quite so spectacular, but in every way a highly refined set, is the Duo Diffusion Autoradiogram, which costs 52 guineas.

Among the less expensive sets, the new AC-DC Console will interest that large section of the public who consider that the radio set should be an article of furniture as well as a source of entertainment. A

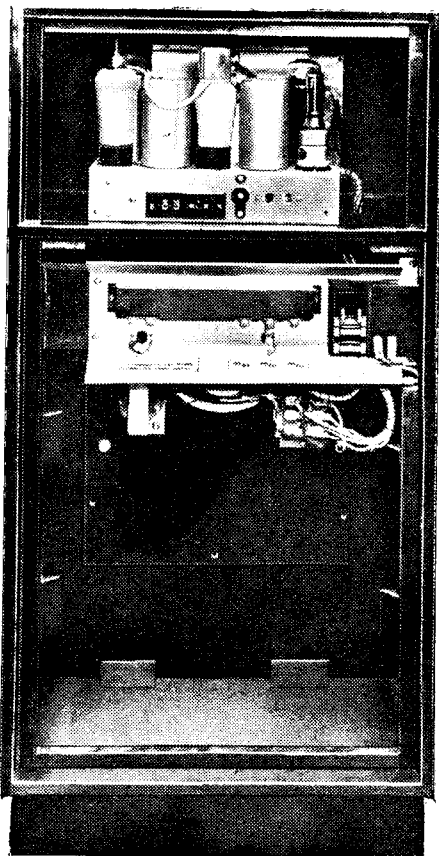

Rear view of H.M.V. universal console.

large upright cabinet houses a 4-valve superheterodyne chassis; the controls are arranged for easy operation from an armchair. The companion AC Console, Model 444, on the other hand, is fitted with a sloping scale.

The new Superhet Portable Fluid Light Six is self-contained with its frame aerial and includes a signal-frequency HF stage; otherwise, the superheterodyne chassis is of a similar design to the H.M.V. "open aerial" sets.

Model 146 battery superhet has many more points of technical interest than the

average receiver of its type. A double pentode QPP output circuit is employed, and the "light-collecting" dial is nearly as easy to read as an illuminated one—which is impracticable in a battery set.

Gramophone Co., Ltd. (H.M.V.), 98-108, Clerkenwell Road, London, E.C.1.

HALCYON (36)

The AVC system of the Halcyon AC7 series of superheterodynes (AC mains) is designed to exercise an unusually large

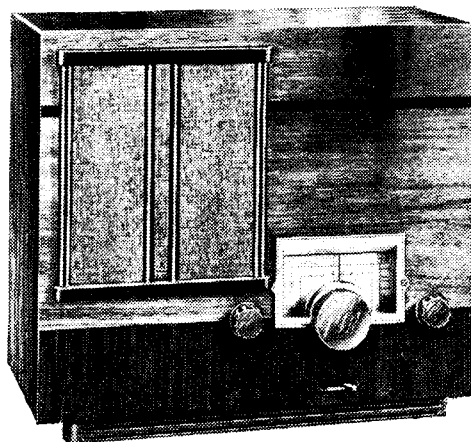

Halcyon universal "straight" receiver.

amount of control, and thus to compensate for severe fading. Table models and radio-gramophones (with or without automatic changing) are available both in this and in the 4701 series of universal superheterodynes, which include Westectors and metal rectifiers. There is also an inexpensive HF-det.-LF universal set in which proper provision has wisely been made for aerial matching.

It is noticed that the new Halcyon sets have obviously been designed with the aim of securing exceptional immunity from breakdown; for instance, no component is supported merely by its own wiring, and double fuse protection is included in universal sets. Further, the sets are so planned that, should a fault develop, it may be easily rectified, as the chassis are accessible without removal from the case or even taking off the control knobs.

Halcyon Radio, Ltd., Sterling Works, Dagenham, Essex.

HARTLEY-TURNER (23)

The "Standard" model loud speakers are being continued unchanged, the DC model at 7 guineas, the 20-watt AC at 8 guineas, and the 40-watt at 9 guineas. A new per-

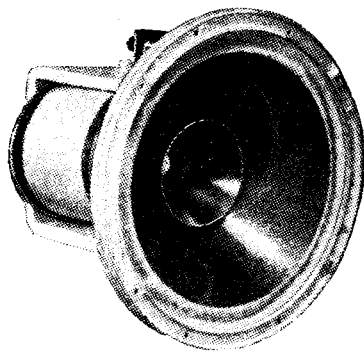

Hartley-Turner twin diaphragm loud speaker.

manent-magnet version of the "Standard" model with nickel-aluminium alloy magnet

has been introduced, and also two entirely new models, one with a re-entrant cone giving a smoother middle register response and the other with a twin diaphragm extending the response to at least 12,000 cycles.

The S7, S12, and M12 receivers and the GA7 and GA12 amplifier kits are again shown, and also modified versions of the S7 and S12 receivers incorporating AVC. The latter, which are known as the S7A and S12A, will be available only as finished sets. Radio-gramophones including these chassis are also shown and are fitted with the "True Bass Baffle." This box baffle is now offered separately in a standard line of cabinets.

Hartley-Turner Radio, Ltd., Thornbury Road, Isleworth, Middlesex.

HAYNES RADIO (10)

The adaptability and flexibility of the Haynes system of receiver construction will appeal to the knowledgeable enthusiast. For this season three tuner units have been designed: Two-circuit 1-HF stage, three-circuit (band-pass) 1-HF stage, four-circuit (band-pass) 2-HF stages. Any one of these units may be followed by either a 6-watt or 14-watt resistance-coupled push-pull output unit, the two being assembled together in a cabinet.

Haynes loud speakers, of which several models are shown, are designed to have the highest possible flux density in the gap. There is also a very useful modulated oscillator, which may be described as a station

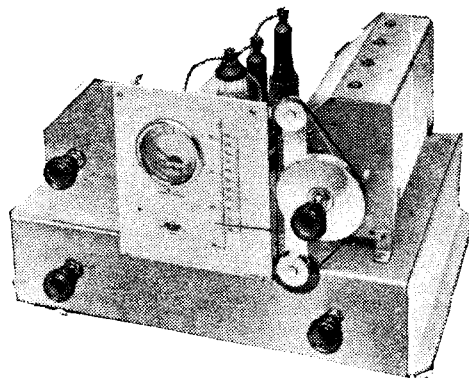

Haynes Radio 2-HF tuner.

finder, as it is directly calibrated in station names. This versatile device operates on AC mains, and is arranged so that the oscillator valve may be modulated by a pick-up, thus permitting gramophone reproduction through a receiver not normally adapted for this purpose. Interesting possibilities of tone correction are thus opened up.

Haynes Radio, Queensway, Enfield, Middlesex.

HELLESENS (21)

Hellesens "Hi-Life" HT batteries in standard and super-power types are shown on this stand, together with a full range of replacement batteries of the correct voltage and size for the majority of portable and transportable receivers on the market.

Hellesens, Ltd., Morden Road, S. Wimbledon, London, S.W.19.

HEAYBERD (25)

A four-valve superheterodyne receiver embodying an up-to-date circuit in which an Octode frequency changer is employed is now included in the products of this firm.

Complete Show Report—

It is an AC set, and the price is 14 guineas. Shrouded mains transformers for valve and metal rectifiers are included, together with a long range of LT chargers, to which some new DC models have been added.

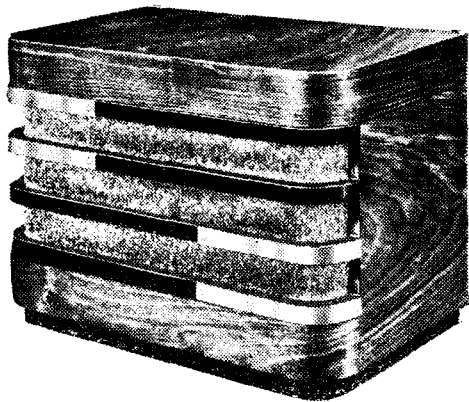

Heyberd four-valve superheterodyne.

A special feature is made of HT supply units giving DC outputs up to 60 mA for operating battery sets in which a large power output valve has been fitted.

F. C. Heyberd and Co., 10, Finsbury Street, London, E.C.2.

HENLEY'S (53)

The Solon electric soldering-iron forms the main display on this stand and models of various sizes are available at prices ranging from 9s. 6d. to 37s. 6d. Resin-coated solder is also shown as well as "Slideback Wires." These are intended for receiver wiring and the ends can be bared for soldering merely by sliding back the insulation.

W. T. Henley's Telegraph Works Co., Ltd., Holborn Viaduct, London, E.C.1.

HIVAC (27)

The valves shown by this firm cover all receiving requirements, and the standard ranges include both battery and mains types. The new Harries output tetrode is shown and this valve is claimed to have characteristics which are superior to those of the conventional pentode. The special

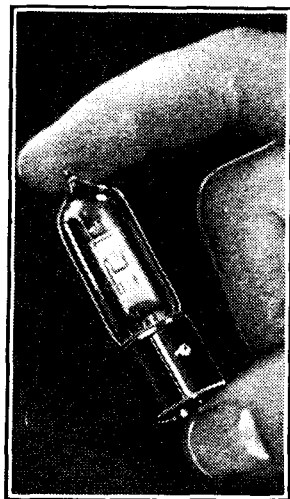

Hivac Midget Valve with base for bayonet socket; a pin-type base is also made.

feature of the valve is that the negative resistance bend is removed, not by introducing a suppressor grid but by critically spacing the anode from the other electrodes.

Midget valves are also shown in both triode and screen-grid types, and they are available with Frequentite bases for use in ultra-short wave equipment. The ACV and

V220 double-variable- μ triodes for volume expansion are on view.

High Vacuum Valve Co., Ltd., 113, Farringdon Road, London, E.C.1.

J.B. (110)

The new season's J.B. programme includes modifications to the Baby-gang series of condensers. These now have a ball-bearing rotor and the superhet. types are available for 465 and 473 kc/s IF amplifiers.

There is an interesting array of new condenser drivers, some have straight full-vision scales, wavelength and degree calibrated as required. Dual ratio drives of 8 to 1 and 100 to 1 for short- and all-wave sets are shown. The Airplane style is new also; this has a large circular dial, a double-ended pointer and separate medium- and long-wave scales. It costs 5s. 9d. with single-ratio and 6s. 6d. with dual-ratio drive.

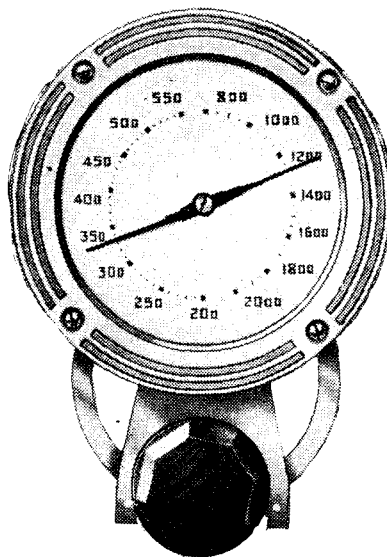

Airplane dial made by Jackson Bros.

Other new items of interest comprise a series of ultra-short wave condensers in single and dual types, also short-wave models.

Jackson Bros. (London), Ltd., 72, St. Thomas's Street, London, S.E.1.

K-B (78)

At last year's Show the K-B superheterodyne was the only modestly priced set with variable selectivity control. This feature is now to be found in sets costing as little as 12 guineas; there is the universal superhet, Model K-B 426, in which the functions of tuning and wave-range switching are carried out by a single knob. Another AC-DC superhet, K-B 425, works with a built-in frame aerial, and includes the unusual feature of push-pull detection. Variable selectivity is included in the 12-guinea K-B 427, for AC mains only, which is also fitted with sockets for attachment of a short-wave converter.

A still more ambitious superheterodyne, also with variable selectivity, is the Model K-B 428, with a preliminary HF stage. A three-circuit "straight" battery set, in which the band-pass filter acts as an intervalve coupling, costs 8½ guineas, while a simpler two-circuit receiver of similar design may be had for as little as £5 17s. 6d.

Models 426, 427 and 428 have the "Foto-tune" system of tuning; the name of the station to which the set is tuned is projected

optically on a translucent screen. Only one name is visible at a time.

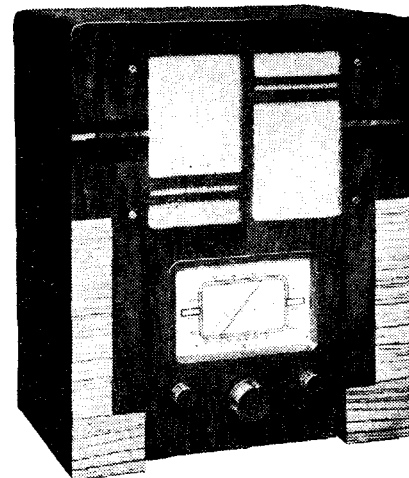

K-B variable-selectivity AC superhet.

The possibilities of the Rejectostat screened aerial lead-in have now been extended so that any number of sets from one to a thousand may be fed from a single aerial.

Kolster-Brandes, Ltd., Cray Works, Sidcup, Kent.

KINGSWAY RADIO (17)

The Simpson Electrical Turntable consists of an extremely compact synchronous motor (50 cycles) combined with a gramophone turntable, and is therefore suitable for use in the construction of radio-gramophones or playing desks. The price is two guineas.

A series of mains and other transformers, chokes and short-wave coils are exhibited. There is also an unconventional HF choke for ultra-short waves, with the winding immersed in a high-resistance liquid. This appears to give the effect of a distributed resistance shunt and prevents absorption effects.

Kingsway Radio, Ltd., 3-9, Dane Street, London, W.C.1.



Simpson's Electric Turntable (Kingsway Radio).

LONDON ELECTRIC APPLIANCES (207)

An extraordinarily compact portable loud speaker set is shown by this firm. Measurements are 8½ in. high, 8 in. long, and 5½ in. deep; four Hivac valves are used in an HF-det-2LF circuit, and the speaker is a Celestion balanced-armature instrument. Total weight is 9lb.; a frame aerial is fitted. The set covers both medium and long wavelengths, and costs 5 guineas.

London Electric Appliances, Ltd., 62, Glengall Road, London, S.E.15.

LAMPEX (24)

The Band-pass Four Receiver is a "straight" HF-det.-LF set with three-circuit tuning, available either as an AC model or for universal AC-DC operation; either

Complete Show Report—

type costs 8½ guineas. A cheaper AC-only set, with a similar arrangement but only two tuned circuits, costs 7 guineas.

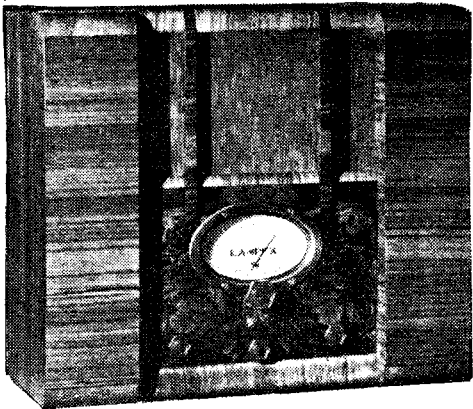

Lampex Superhet Six.

Two battery sets are shown, including a three-valve detector-2LF combination, at the low price of 4 guineas, complete with batteries. There is also an AC superheterodyne with the unusual advantage—at its price of 12½ guineas—of an HF stage.

Lampex Radio and Electric Co., Phantom House, 62, Brewery Road, Islington, London, N.7.

LISSEN (86)

The Lissen sets for the present season include models for battery, AC, and universal mains supply. The "standard" production is a four-valve AC superhet. with a conventional circuit arrangement, which costs 11 guineas. A companion battery set is available at the same price.

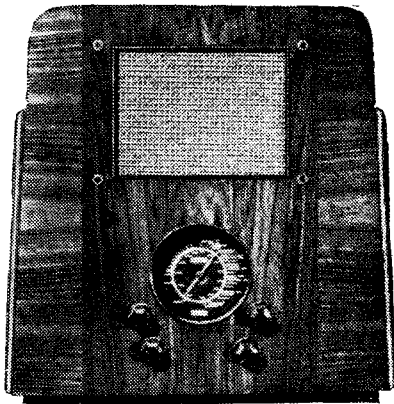

Lissen superheterodyne receiver.

The universal superhet. has three valves and a metal rectifier, and employs a PM speaker. There is also a "straight" universal set, and two battery receivers of the same type.

An all-wave superheterodyne for AC mains, together with a short-wave kit set, are the most recent productions.

Lissen, Ltd., Worple Road, Isleworth, Middlesex.

McMICHAEL (68)

The new season's programme comprises six models, led by the Model 135 Twin Speaker Superhet. at 15 guineas. This receiver employs a four-valve circuit with constant-gain couplings, and notable external features include the "stereophonic"

twin loud speakers and a large diameter tuning scale illuminated by a spotlight inside the lid of the cabinet.

A cabinet design of striking appearance has been adopted in the new Model 235 superhet., which has a three-valve circuit comprising a triode-pentode frequency-changer, pentode IF amplifier, and double-diode pentode combined detector, AVC and output valve. The price is 12 guineas, and a universal model is also available at the same price.

The Models 335 and 435 are battery and AC mains transportables incorporating the "Giant Dial" used in the Twin Speaker set. An HF amplifier precedes the frequency-changer in both sets, a pentode is used for IF amplification, and a double-diode-triode for detection and AVC. The output stage in the battery set is a QPP valve and in the mains set a Catkin pentode. The price of the battery model is 14 guineas and of the AC model 16 guineas.

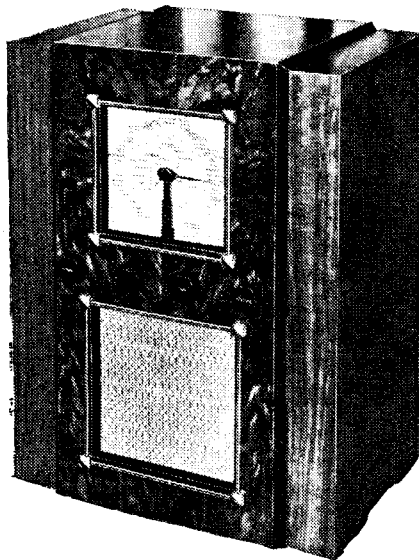

McMichael Model 435 transportable.

The SMC Suitcase Portable at 15 guineas is continued unchanged, as its capabilities are already widely known and appreciated.

McMichael Radio, Ltd., Wexham Road, Slough, Bucks.

MARCONIPHONE (11 & 69)

No fewer than fourteen receivers and radio-gramophones are included in the Marconiphone programme. Although most of the sets are superheterodynes, the straight circuit still has its attractions for certain requirements, and its possibilities have been fully exploited in the new AC Models 235 and 240. The first is a table model costing

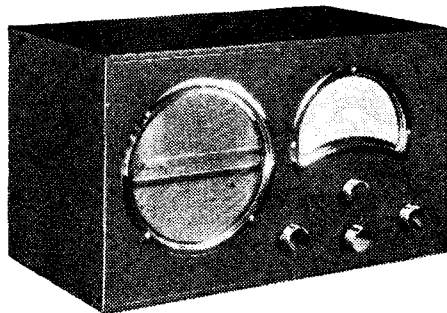

Marconiphone "straight" mains receiver.

only 8½ guineas, with an HF-det.-LF circuit including a resistance-coupled output pentode giving 3 watts—an abnormally high

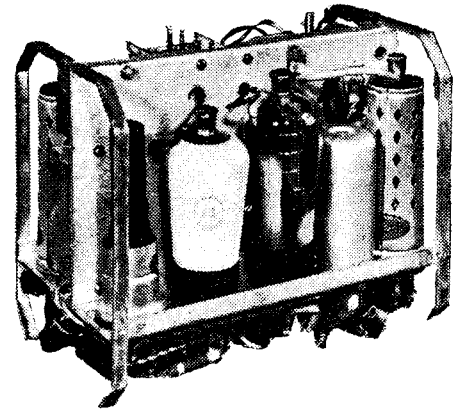

Chassis of Marconiphone car radio receiver.

figure for a set at the price. Model 240 is an upright console set with the same chassis which costs only 12½ guineas.

The new superheterodyne, Model 236, costing 15 guineas, is also an upright console for operation on either AC or DC, in which three valves operate in a reflex circuit. A double-diode pentode carries out the functions of IF amplifier, detector, source of AVC voltage, and, by reflexing, of LF amplifier. A "high-fidelity" switch for local-station listening seems to be a very practical innovation.

In many respects the Marconiphone car radio receiver differs from current practice. For instance, it is divided into three units: receiver, remote-control panel, loud speaker and power supply. Control is from the steering column, and HT is stepped up from the car battery by means of a vibratory generator.

Perhaps the most important of the new Marconi valves is the triode hexode frequency changer for AC-DC sets, with a 13-volt, 0.3-amp. heater. The latest high-slope output pentode is specially attractive for sets with high-level detection.

Marconiphone Co., Ltd., 210-212, Tottenham Court Road, London, W.1.

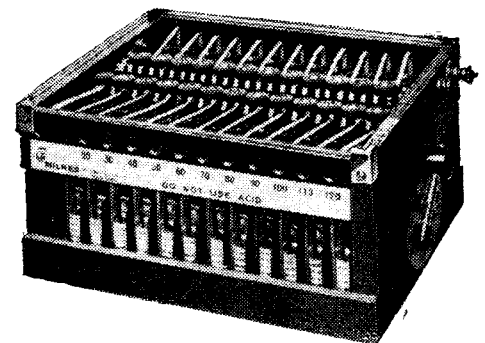

Milnes "Minor" H.T. accumulator unit.

MILNES (204)

As an effective solution to the HT battery problem, the Milnes system has acquired a high reputation. In effect, it may be described as an HT converter; a number of small nickel-cadmium cells are assembled in a crate and wired to a switch in such a way that they may be connected in series for discharging and in series-parallel groups for recharging from a six-volt accumulator, which also supplies LT to the set when not charging.

Complete Show Report—

The latest model is the Minor, which, in the 120-volt size, costs £3 7s. 6d., but several other capacities and many other voltages are available.

Milnes receivers specially designed to operate with these batteries are also shown; the 2-HF model with AVC is technically the most interesting.

Milnes Radio Co., Ltd., Church Street, Bingley, Yorks.

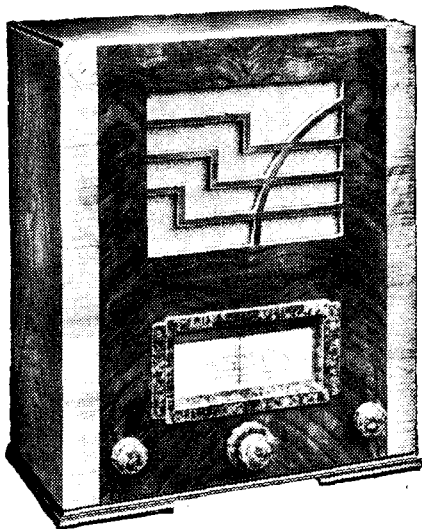

The Mullard MU35 superheterodyne.

MULLARD (75)

First consideration on this stand must be given to the MU35 superheterodyne. It is designed for AC/DC operation and a band-pass filter precedes the octode frequency-changer. A single IF stage is fitted and feeds a duo-diode which not only provides detection and AVC, but also automatic noise suppression. This is achieved by the application of a negative bias to the detector diode. A triode LF stage follows and feeds the pentode output valve. The set is priced at 12 guineas.

The MB4 receiver is of the battery type and four valves are employed. A battery economy system of output is embodied, and the set is listed at /9 12s. 6d. Three-valve battery receivers, the MB3 and MB3A, at 8 guineas, are also shown.

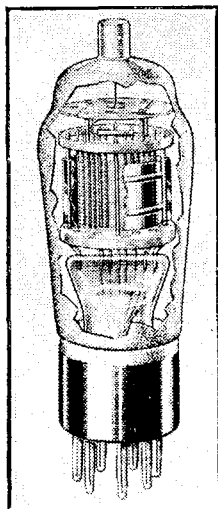

Mullard FC2 octode frequency-changer.

a new range of AC/DC types. Domed bulbs and mica supports have been adopted for the mains types in order to secure a maximum of rigidity.

In addition to receivers, valves naturally occupy a prominent place on this stand, and all the well-known types are represented. A new frequency-changer is shown, and this is the FC2, an octode designed for battery operation, and there is a new driver valve, the PM2DL, for Class B operation. The heater current of many AC types has been reduced, and there is

Mullard Wireless Service Co., Ltd., Mullard House, Charing Cross Road, London, W.C.2.

N.R.S. (12)

The principal activity of the National Radio Service Company is in connection with repair and similar work. However, a number of instruments are shown on the stand, including a series of Mavox short-wave sets designed largely for overseas use. The "Ether Cruiser" covers short waves between 13 and 63 metres, as well as the 220-550 metre band.

Brown headphones, both of the adjustable reed and flat diaphragm types, are now made under licence by N.R.S. The firm also specialise in the installation of car radio receivers of all types, and, of course, also undertake the suppression of interference from the ignition system of the vehicle.

It seems that the crystal set exhibited here is the only one of its kind in the Show.

National Radio Service Co., 15-16, Alfred Place, London, W.C.1.

OLDHAM (66)

The chief feature of the Oldham exhibit this year is the new Capacity Clock for in-

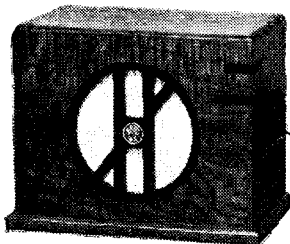

Mavox Tropical battery receiver (N.R.S.).

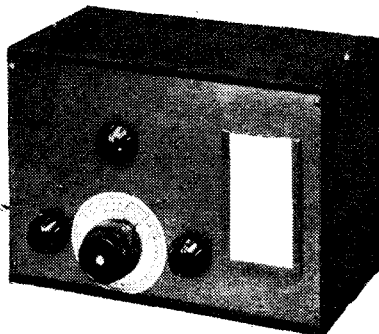

The Ormond Model 607 receiver.

ORMOND (33)

The mains receivers shown by this firm are of similar basic design, but the Model 606 is of the AC/DC type, while the 607 is for AC only. Three valves are arranged as an HF stage, a detector, and a pentode output stage. A similar set for battery operation is provided with a built-in frame aerial.

A range of components is also on view, and this includes variable condensers of both single and gang types as well as reaction condensers. Both permanent-magnet and energised moving-

coil loud speakers are to be found not only in chassis form but also in a variety of cabinet styles.

Ormond Engineering Co., Ltd., Ormond House, Rosebery Avenue, London, E.C.1.

ORR RADIO (96)

The AC/45 receiver includes variable selectivity, and a response extending as high as 7,000 c/s is claimed. The set is a superheterodyne having an octode frequency-

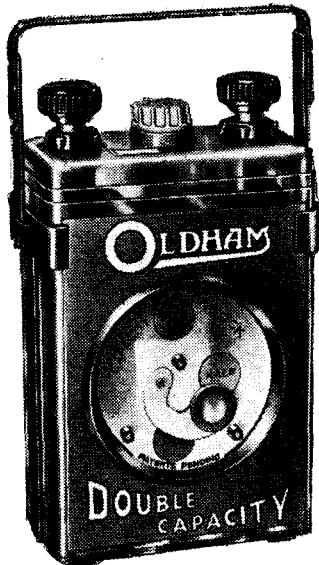

Novel charge indicator incorporated in Oldham L.T. cells.

dicating the state of charge in their LT accumulators. It is a most useful fitment and is embodied in all cells with the exception of the unspillable and, of course, the jelly type. HT accumulators and the full range of dry batteries are also shown.

Oldham and Son, Ltd., Denton, Manchester.

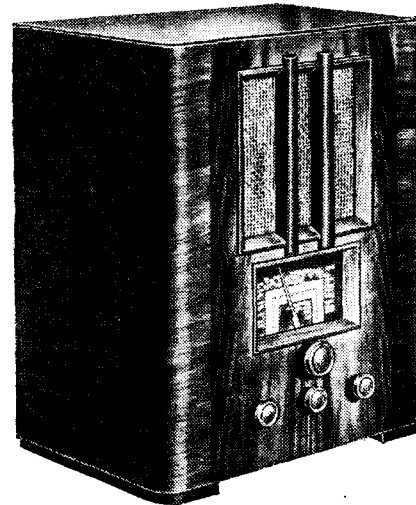

The Orr Radio Invicta AC/45 superheterodyne.

changer, one IF stage, a duo-diode detector, and a pentode output valve. It is priced at 11½ guineas. There is also an all-wave set, Model AW/56. This is AC operated and covers 13/550 metres and 800/2,000 metres in five bands. It costs 15 guineas.

In addition, a number of straight three-valve battery receivers are shown, including one, the FS/36, Fisherman's Receiver, which is arranged to tune to the 100-metres band. It is a three-valve set, and is priced at £9 19s. 6d. Universal sets are also to be found.

Orr Radio, Ltd., 79a, Parkhurst Road, London, N.7.

OSSICAIDE (121)

Power amplifiers and public address equipment constitute the principal interest on this stand. A new development is a mobile amplifier and associated apparatus for fitting in a motor car and for operating from the starter battery. It is rated at six watts.



Ossicaide 20-watt amplifier with gramophone and receiver units.

Apparatus that enables clock chimes to be amplified and reproduced in public buildings by means of loud speakers from a small chiming clock is shown, together with a range of deaf-aid appliances of extraordinary compact form and in which special midget valves are employed.

Ossicaide, Ltd., 447, Oxford Street, London, W.1.

PERTRIX (40)

High-tension batteries of several capacities and grades, and with an extremely

good choice of voltage ratings and shapes, comprise the main Pertrix exhibit. The latest "Special Power" battery seems particularly attractive for high-quality battery sets of relatively high consumption.

The new semi-unspillable accumulator cell is, as its name implies, not intended to be stood on its head, but will stand a lot of careless usage, and is a useful general-purpose type costing 11s.

Britannia Batteries, Ltd., Union Street, Redditch, Worcs.



Pertrix semi-unspillable accumulator.

PHILIPS (62)

Many departures from conventional practice are to be found in the Philips 575A "all-wave" superheterodyne, which covers short waves between 16 and 50 metres as well as the normal broadcast bands. There is a signal-frequency HF stage and, at the other end of the set, a triode output valve. Variable selectivity is provided, and the loud speaker is of the permanent-magnet type—very unusual in an AC set nowadays. The cost of this model is 18½ guineas. At the other end of the price scale is a simple detector-LF two-valve AC set at 6½ guineas only.

Between these two extremes is a wide choice of intermediate models. The universal superhet., Type 585U, embodies many highly practical features, while those who prefer the "straight" circuit can get a high performance from the 2-HF "Super-inductance" model, for which an abnormally good signal-to-noise ratio is claimed. Several of the chassis are available either



Philips radio-gramophone, Model 539A.

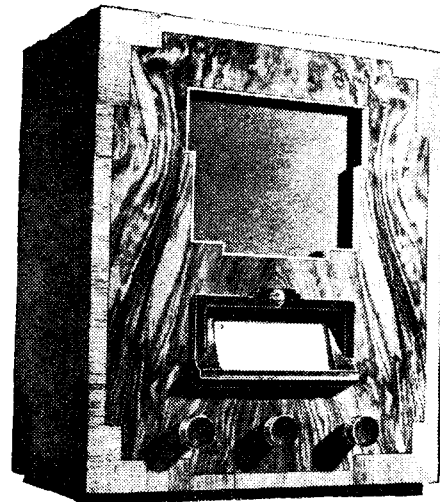

Philips universal receiver, Model 838U.

as table models or in console or radio-gramophone form.

Philips Lamps, Ltd., 145, Charing Cross Road, London, W.C.2.

PIX (201)

This firm is showing the Pix Invisible Aerial, which consists of a narrow strip of adhesive fabric carrying a ¼ in. strip of aluminium foil. It can readily be pressed on to any surface, and so forms a ready means of erecting an indoor aerial. It is sold in 30ft. rolls at 2s. The rest of the exhibit includes valves in both battery and mains types, lightning arresters, and volume controls.

British Pix Co., Ltd., 118, Southwark Street, London, S.E.1.

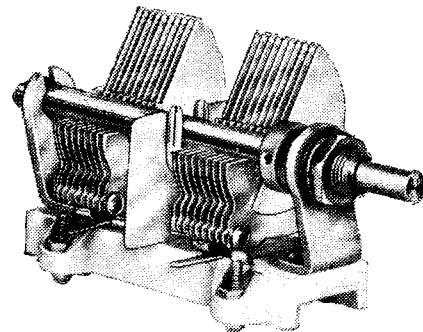

Polar dual short-wave condenser, Type E.

POLAR (49)

The Polar range of gang condensers remains substantially unchanged apart from a few modifications to the Midget models. A four-gang type has been introduced, which is shown in straight and superheterodyne types, at 22s. each. All the Midget condensers are now assembled in a new one-piece steel chassis giving greater strength and rigidity, and so precluding any possibility of warp or twist which might disturb the initial matching of the sections.

Whilst tracking oscillator sections for 110 kc/s is standardised, condensers for use with 465 kc/s IF amplifiers can be supplied.

A new short-wave condenser, the type G, is shown. This is assembled on a Steatite base as used for the type E, but it is fitted with zinc-alloy vanes, and the two-gang model has separately insulated rotor sections. The single-gang style costs 6s., and the two-gang 12s. 6d.

Complete Show Report—

Single condensers in a variety of styles, together with a full range of condenser drives, complete a very interesting display.

Wingrove and Rogers, Ltd., 188-189, Strand, London, W.C.2.

PORTADYNE (99)

The principal exhibit here is an AC-DC superheterodyne with the latest refinements, which costs 12 guineas. A companion battery model is made at the same price, while the mains chassis is also available as a radio-gramophone at 23 guineas. Another set, for battery feed, includes a "straight" HF-det.-LF circuit.

Portadyne Radio, Gorst Road, N. Acton, London, N.W.10.

PRIMUS (19)

This stand is devoted to a display of high-tension batteries at competitive prices and to a range of the Primustatic loud speaker models. These loud speakers operate on the electrostatic principle, and four models are available, ranging from the Chassis D model, measuring 14in. x 16in., at 25s. for battery sets and 27s. 6d. for mains, to the Giant model chassis for mains only and measuring 48in. x 60in. at 10 guineas.

Primus Manufacturing Co., Ltd., Primus House, Willow Street, London, E.C.2.

PRISM MFG. CO. (116)

The radio-gramophone shown by this firm has a receiver chassis which includes two HF stages with Litz-wound coils. The power output is 4 watts. An unusually high standard of reproduction is claimed and attributed to the employment of a special reproducing system in which two loud speakers are involved. It is for AC operation and is priced at 45 guineas.

Portable amplifiers are also shown. The ACA/51 is for AC working and has an output of 8 watts with a gain of 110 db. The price of 30 guineas includes the microphone. A similar amplifier for AC/DC operation is available, and there is also a horn-type loud speaker.

Prism Manufacturing Co., California Works, Brighton Road, Belmont, Surrey.

PYE (84)

The new range of Pye receivers in the "T" series show a strong family likeness in the style of cabinet adopted. In one

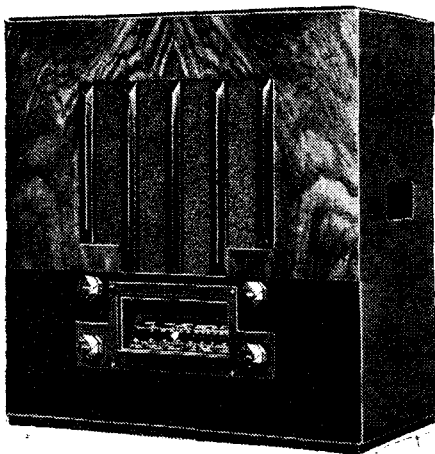

Pye Model TP/B portable receiver.

of the sets employing QAVC an improved circuit has been introduced which ensures freedom from distortion on weak signals.

The Model T7 AC receiver is designed for use with an elevated aerial, and the circuit comprises a band-pass filter leading to an octode frequency-changer, which is followed by a pentode IF amplifier, double-diode detector and separate pentode output valve. The price is 12 guineas, and the equivalent battery Model T6, at the same price, includes a double-diode-triode detector and QPP output stage.

A triode valve rated at 2.8 watts occupies the output stage in the Model T9 at 14 guineas. This receiver employs the new compensated QAVC system and is fitted with a tuning indicator.

Two self-contained portables, the Model TP/B and TP/AC at 15 guineas and 16 guineas respectively, complete the new series.

The "Cambridge" receiver, Model CR/AC at 15 guineas, is being continued, as well as the SE/AC console at 18 guineas, while other interesting products of the Pye factory include the "straight" battery portable Model S/Q at £11, the Model SE/U universal superheterodyne at £16, and a simplified AC mains superhet, the Model T21, at £13.

Pye Radio, Ltd., Africa House, Kingsway, London, W.C.2.

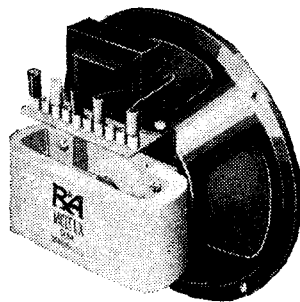

R. & A.
"Multex"
reproducer.

R. & A. (56)

The "Alpha" permanent-magnet moving-coil chassis with its unique principle of diaphragm suspension is the leading product exhibited by this firm. It has a 10½in. diaphragm and is fitted with an output transformer giving no fewer than sixty-five different ratios. The price is 55s. The "Multimu," at 42s. 6d., incorporates a switch-operated matching control referred to as "impedance tuning," and the new magnet system gives a high sensitivity. Lastly, there is the "Multex" 8in. reproducer, at 32s. 6d., which is supplied with a universal transformer giving thirty alternative ratios by means of plug and socket connections. This reproducer is also supplied in a walnut cabinet with ebonite fret at 47s. 6d.

The Type OP58 output transformer fitted to the R. & A. "Alpha" reproducer is also obtainable separately at 18s. 6d. Of the sixty-five ratios twelve are allocated to push-pull arrangements.

The requirements of manufacturers are catered for by a display of special models in the office on this stand.

Reproducers and Amplifiers, Ltd., Frederick Street, Wolverhampton.

R.A.P. (106)

Among the receivers shown on this stand the "Transatlantic" model is worthy of attention. A heptode frequency-changer is used with a band-pass pre-selector and one IF stage operating at a fre-

quency of 117.5 kc/s. AVC is fitted and the set is of the all-wave type, having tuning ranges of 19.5/52, 200/550, and 1,000/2,000 metres. It is an AC set, but an AC/DC model is available. The price is 12 guineas. The Continental receiver is listed at 9 guineas and covers the medium and

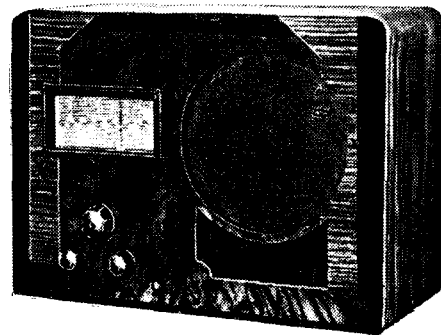

The R.A.P. Continental receiver.

long wavebands. An intermediate frequency of 473 kc/s is used and the power output is 3.5 watts. There is, in addition, a range of battery superheterodynes.

R.A.P., Ltd., Ferry Works, Thames Ditton, Surrey.

R.G.D. (88 & 89)

Although the larger models (such as 1202 and 1203) are retained, interest in this year's R.G.D. exhibit centres mainly around a series of slightly simpler sets. But it must not be imagined that these new productions have been pruned down to the point where technical interest disappears; on the contrary, they are highly refined sets—trust R.G.D. for that—giving promise of extremely satisfying performance in every direction.

Model 704 embodies a 7-valve superheterodyne circuit with signal-frequency HF stage and output triode. Three valves are controlled by the AVC system and variable selectivity is included. A separate oscillator valve and twin speakers are fitted.



R. G. D. console radio receiver.

As a non-automatic radio-gramophone, the set costs 48 guineas; as an automatic, 55

Complete Show Report—

guineas, or as a radio console without gramophone equipment (a new departure for R.G.D.), 38 guineas; AC or DC models are available.



R.G.D. 12-valve Model 1204.

A somewhat similar but even more ambitious chassis is included in the Model 705 all-wave automatic radio-gramophone, which covers short as well as medium and long broadcast wavelengths. The HF stage is effective on all bands, and there is a two-stage IF amplifier; four valves are AVC-controlled. Again, variable selectivity and triode output are included, but, in view of the "all-wave" feature, wavelength calibration instead of station-name indication is provided.

Radio Gramophone Development Co., Ltd., Frederick Street, Birmingham.

R.I. (102)

This firm is specialising in the design of receivers for educational purposes, and five models have been approved by the Central

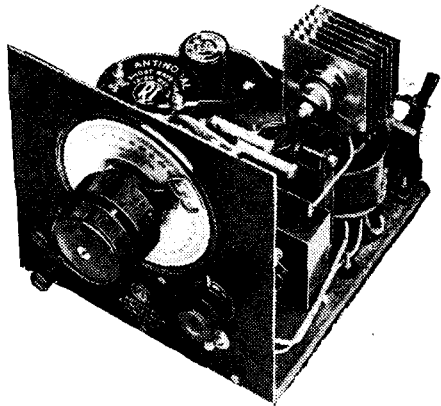

R. I. short-wave converter.

Council for Schools Broadcasting as providing the necessary standard of reproduction. The simpler mains-driven models include an HF-detector-LF circuit, and are operated in conjunction with an external loud speaker mounted on a 30in. baffle board. Battery sets are also manufactured,

as well as a nine-stage mains superheterodyne. Gramophone equipment is available with any model.

R.I. short-wave converters are now available for DC, AC or battery operation, and are being supplied in a new form for the use of constructors. Low-frequency transformers, chokes, and short-wave and other tuning coils are exhibited.

Radio Instruments, Ltd., Purley Way, Croydon, Surrey.

R.S.G.B. (202)

This stand is the natural rendezvous of all keen wireless amateurs, especially those interested in experimental transmissions.

The amateur apparatus displayed includes some fine examples of crystal-controlled transmitters, short- and ultra-short-wave receivers, also a short-wave converter.

Radio Society of Great Britain, 53, Victoria Street, London, S.W.1.

RADIOLAB (229)

Whilst each of the new Radiolab test units are complete instruments and can be employed separately in their respective spheres, they have been designed for convenient interconnection, so enabling a complete testing equipment to be assembled by gradual acquisition of the individual units. These comprise the All-Purpose Tester, an AC/DC measuring instrument, modulated

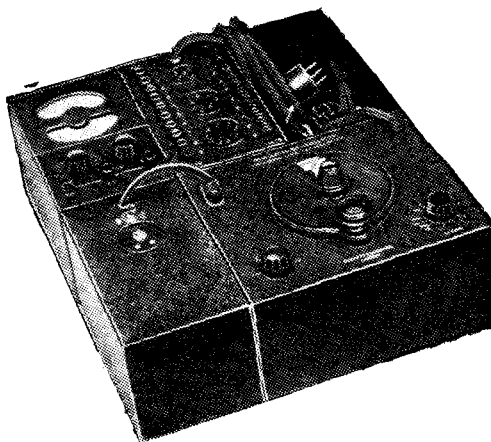

Radiolab complete test set.

HF oscillator, Omni Selector testing unit, and associated apparatus.

Containing cases for three and six units are available in which the separate parts can be assembled with provision for spares.

The modulated oscillator costs £7 15s., the All-Purpose Tester £5 5s., and the Omni Selector £3 5s. A three-compartment case is priced at 30s., and the six-unit model at 45s.

Everett, Edgumbe and Co., Ltd., Colindale Works, Hendon, London, N.W.9.

RAWLPLUG CO. (120)

The well-known "Rawlplugs" have several radio uses, particularly as an aid to the installation of outside aerials. The makers are also exhibiting Plastic Metal, Plastic Wood, and a low-priced electric sol-

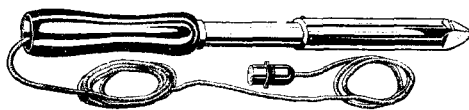

Rawlplug soldering iron.

dering iron which costs 7s. 6d. There is also a special screwdriver with a grip attachment which facilitates the insertion of screws in awkward positions.

Rawlplug Co., Ltd., Rawlplug House, Cromwell Road, London, S.W.7.

REGENTONE (93)

The new season's programme of Regentone includes a range of AC, Universal and battery sets which are shown as table models and as radio-gramophones. All embody a

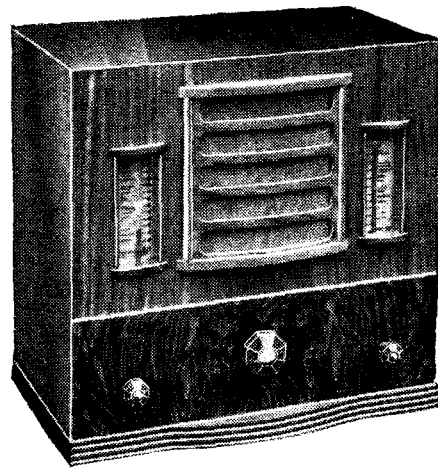

Regentone model AC/56 superheterodyne.

distinctive tuning system in which a column of light replaces the more orthodox pointer, whilst the scales are station-calibrated.

The series includes a five-valve, eight-stage superheterodyne, which costs 11 guineas for AC operation and 11½ guineas as a universal AC/DC set. Its specification is quite up to date, and in the case of the universal model has a safety mains connector on the back which automatically disconnects the mains supply should it be removed without first switching off.

A complete range of Regentone mains units is also shown.

Regentone Products, Ltd., Worton Road, Isleworth, Middlesex.

RIST (213)

Flexible wires including twin flat extension cord for loud speakers, mains leads, screened flexible conductors, battery cords, etc., are displayed on this stand. The colour-coded connecting wire covered with "push-back" sleeving is also an important product of this firm, which specialises in the preparation of wiring assemblies to manufacturers' specifications and drawings.

Rist's Wires and Cables, Ltd., Freemantle Road, Lowestoft.

ROLA (43)

The Type D12 high fidelity moving-coil loud speaker is given prominence on this stand. For DC excitation the price is £5 10s., and for AC £7 15s. The speech coil has an impedance of 8 ohms, and transformers for any given output conditions can be supplied.

Two new "wide range" extension speakers have also been added to the Rola programme. The type number of these models, which have 9¼in. diaphragms, is F720 PM. One is for receivers requiring an extension speaker of the low impedance type and costs £1 7s. 6d. for the chassis only, or £2 15s. in a burr walnut cabinet

Complete Show Report—
lined with Celotex. The other model is fitted with a multi-range transformer for

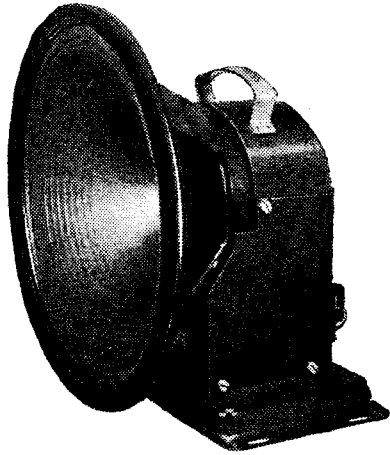

British Rola Type D12 loud speaker.

high impedance outputs and is priced at £1 15s. for the chassis and £3 2s. 6d. in cabinet.

New 6in. and 8in. speakers with both permanent magnet and energised magnets and of dustproof construction are also shown, while a special car radio reproducer with 6in. diaphragm, also incorporating the dust-proof features, is available in permanent magnet and energised types.

British Rola Co., Ltd., Minerva Road, Park Royal, London, N.W.10.

SIEMENS (100)

The "Full o' Power" range of HT batteries shown on this stand is made in a wide variety of voltages and capacities for all battery receiver requirements, and special batteries have been produced for replacement purposes in well-known receivers requiring batteries of special dimensions.

Siemens Electric Lamps and Supplies, Ltd., 38-39, Upper Thames Street, London, E.C.4.

SONOCHORDE (54)

The exhibit on this stand is largely devoted to the practical applications of piezo-electric crystals to broadcast reception.

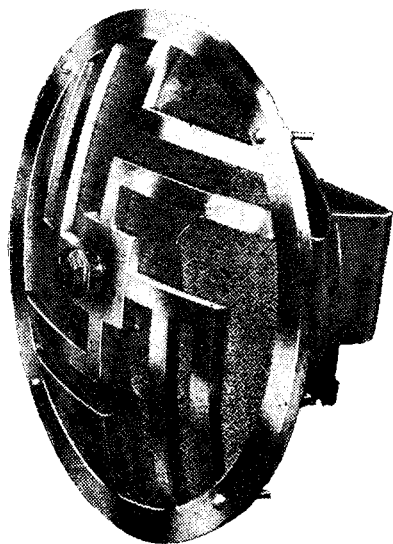

Sonochorde "Piezo-coil" loud speaker.

Perhaps the most popular use to which the Rochelle salt crystal has been put is in the construction of gramophone pick-ups, and

these are represented by the "Standard" Model S8, at 42s., and the "De Luxe" model, fitted with a specially selected crystal cartridge and with self-aligning bearings in the swivel head, at 4 guineas.

Among the large variety of loud speaker units the Type R155 tweeter, at 21s., and the "Piezo-coil" speaker, at 5 guineas, may be selected as of outstanding interest. The latter comprises a Sonochorde "Senior" PM moving-coil loud speaker with 10 $\frac{1}{2}$ in. cone in combination with the tweeter unit. The two sections of the loud speaker are coupled by a continuously variable tone control, the knob of which is mounted in the centre of the protective fret.

Other applications of the piezo-electric crystal which are represented include diaphragm and sound cell microphones, vibration pick-ups, and other associated apparatus.

Sonochorde Reproducers, Ltd., Rothermel House, Canterbury Road, London, N.W.6.

SOUND SALES (108)

This stand is devoted chiefly to a display of mains equipment, including transformers, chokes, and condensers of all types. Special shielded chokes for interference suppression are also made, with current-carrying capacities up to 30 amperes.

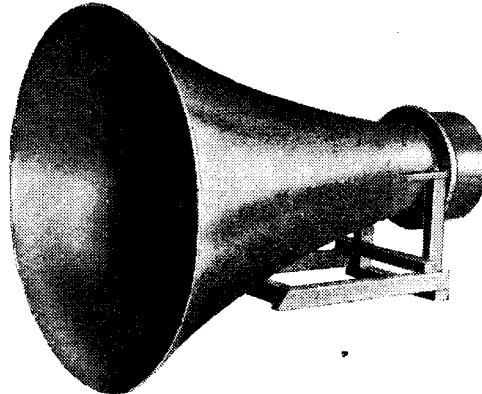

Sound Sales light P.A. speaker.

The Push-Pull Quality Amplifier occupies a prominent position on the stand, and is available with an output of 4 watts or 12 watts, while a radio feeder unit can be obtained. An amplifier with an output of no less than 30 watts obtained from a pair of PX25A valves operated in "low-loading" is shown.

Variable selectivity IF transformers for a frequency of 465 kc/s are on view and priced at 10s. Litz-wound iron-core coils are used, and the mechanical arrangements are such as to permit ready ganging of the controls.

Two new loud speakers are to be found; one is of the horn type for PA work, and will handle up to 5 watts; it is priced at £8 10s.

Sound Sales, Ltd., Tremlett Grove Works, Junction Road, London, N.19.

SUFLEX (205)

This firm is showing insulated sleeving in a variety of sizes and colours, also sleeving of which one particular pattern is designed for use in very high-voltage circuits.

Suflex, Ltd., Aintree Road, Perivale, Greenford, Middlesex.

SWIFT LEVICK (113)

The display of finished permanent magnets of all types includes magnets constructed from the latest "Alnico" alloy,

the constituents of which include cobalt as well as nickel and aluminium. Sets of individual components suitable for assembly by manufacturers of loud speakers in their own factories are also shown.

Swift Levick and Sons, Ltd., Clarence Steel Works, Sheffield.

T.C.C. (37)

The exhibit on this stand comprises fixed condensers of every conceivable variety. Mica dielectric types and non-inductive

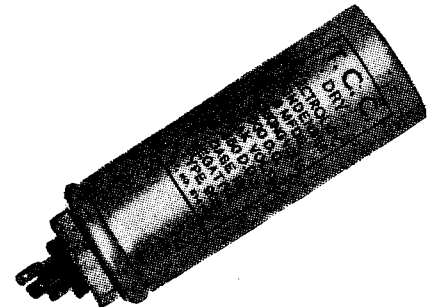

T.C.C. Type 902 electrolytic condenser.

tubular paper condensers for receiver circuits form an important section, and there are also high capacity paper condensers in many different voltage ratings for smoothing equipment. Dry and aqueous electrolytic condensers are on view and are available in voltage ratings between 12 volts and 550 volts, the dry type being made in waxed cartons and metal boxes.

An important section of the display is that devoted to anti-interference equipment and many examples are shown. Special types are available for refrigerators, sewing machines and hair dryers.

Telegraph Condenser Co., Ltd., Wales Farm Road, N. Acton, London, W.3.

T.M.C.-HYDRA (29)

T.M.C.-Hydra condensers are shown in rectangular metal cases for working potentials ranging from 300 volts to 1,500 volts DC. As in every case the test voltage is more than twice the working potential the margin of safety provided is very large.

There is a series of block condensers, also a range of tubular models rated at 600 volts DC working in capacities of from 0.0001 mfd. to 0.1 mfd. They cost between 6d. and 1s. 3d. each according to capacity.

A new development is the Varidep transverse current microphone constructed on an entirely new principle. It is housed in a compact bakelite case available finished in various colours. The price is £7 7s., or mounted in a stand £8 8s., and a special astatic transformer for it costs 19s. 6d.

Telephone Manufacturing Co., Ltd., Hollingsworth Works, Martell Road, London, S.E.21.

TANNOY (90)

Portable public address units and band equipments are prominent among the wide range of electro-acoustic apparatus manufactured by this firm. The Model GUB10, designed for AC, DC or battery operation and sold complete with microphone, gramophone turntable and loud speaker for 48 guineas, is a recent addition to the range, as is the GM12A equipment at 45 guineas. The latter includes a 12-watt amplifier with a characteristic flat within 2 db. from 50 to 16,000 cycles. A larger edition of this equipment, the GM50A, has an output of

Complete Show Report—

50 watts undistorted, yet weighs only 74lb. The price is 50 guineas.

For large public address installations the Tannoy rack system has been introduced,

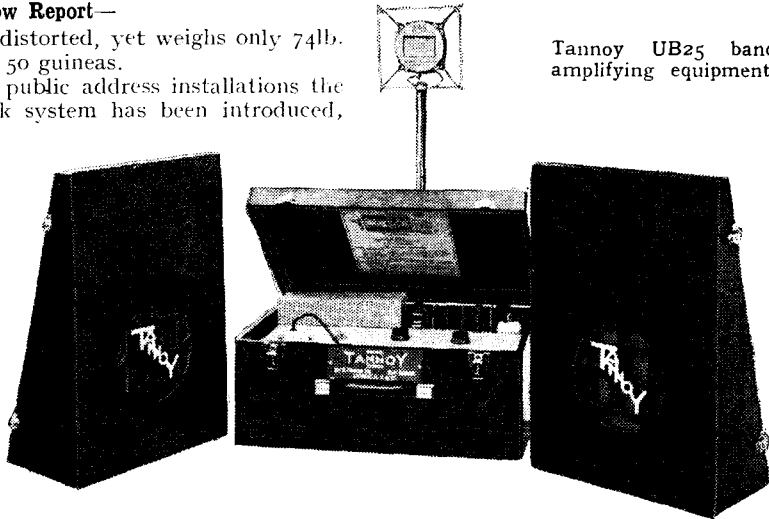

Tannoy UB25 band amplifying equipment.

and in view of the recent interest in loud speaker tests a complete response curve recorder built on this principle is attracting wide attention.

Additions to the range of loud speakers include the new PS projection type with directional baffle, and the range of microphones now includes a laboratory type condenser microphone with a substantially level response from 50 to 10,000 cycles.

In conclusion, mention should be made of the very workmanlike Model RG50 radio-gramophone specially designed for use in schools.

Tannoy Products, Canterbury Grove, London, S.E.27.

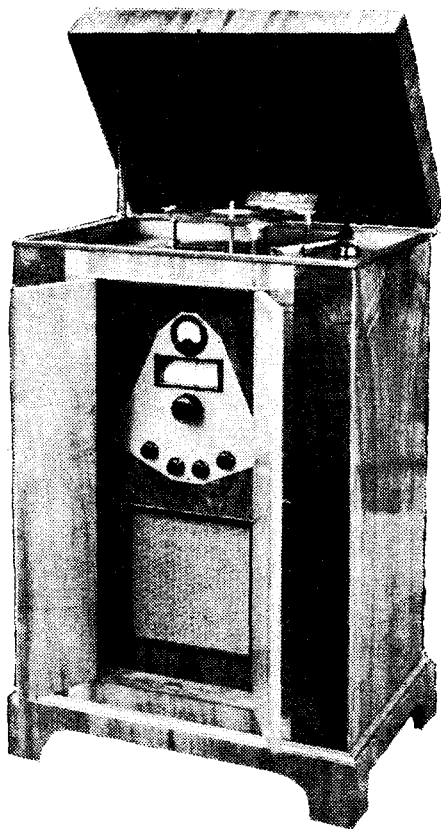

Tannoy RG50 radio-gramophone for schools.

TUCKER EYELET CO. (122)

The display on this stand is of a wide variety of small metal pressed parts which are extensively used in the manufacture of components and receivers.

George Tucker Eyelet Co., Ltd., Jameson Road, Aston, Birmingham, 6.

362 VALVES (212)

This stand is devoted to a display of receiving valves of both directly and indirectly heated types. The former are available not only in 2-volt, but also in 4-volt and 6-volt models, while the indirectly heated class embraces all modern types of valve; a

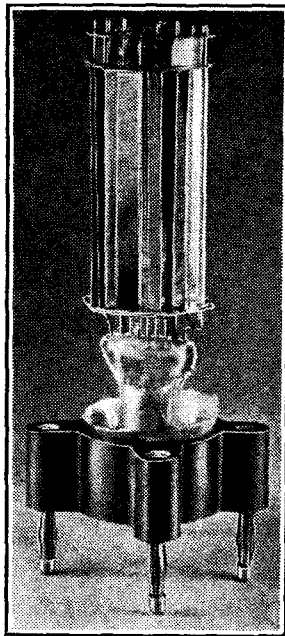

Interior of the 362 PX50 valve.

duo-diode-triode is being introduced, and also a heptode frequency changer. Several directly heated power valves, the PX25 and PX50, are shown, and are recommended as being also suitable for small transmitters.

The 362 Radio Valve Co., Ltd., Stoneham Road, Upper Clapton, London, E.5.

ULTRA (73)

The Clock-Face tuning dial fitted to all the receivers shown by this firm is alone sufficient for the sets to warrant more than a passing glance, for it is not only simple and of pleasing appearance but legible. The Model 25 is a superheterodyne of the three-valve type with a triode-pentode frequency-changer and a duo-diode-pentode output valve. A neon tuning indicator is fitted. The AC table model is priced at 12 guineas, and both consoles and radio-gramophones are shown.

The Model 66 is also a three-valve receiver, but it is a straight set with

one HF stage. An HF pentode is used for the detector, and the output is also provided by a pentode. A special filter is included for reducing interference from Droitwich, and the radio-gramophone model is

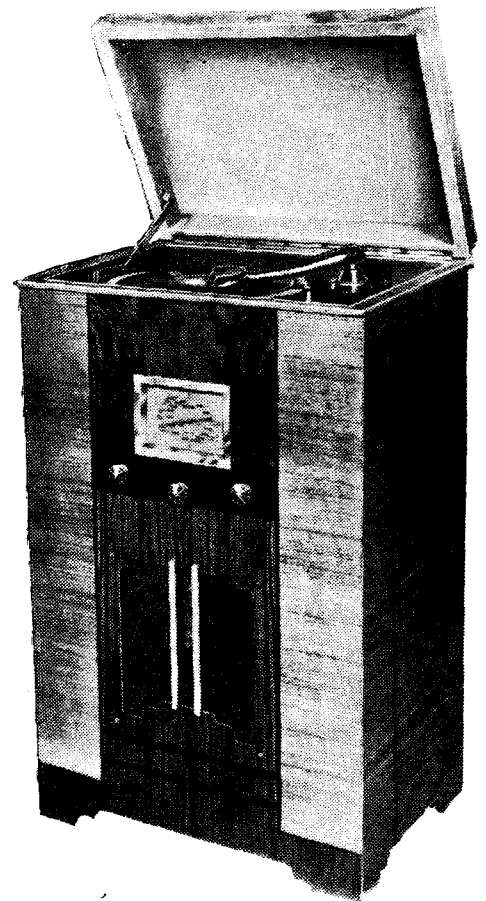

The Ultra Model 66 radio-gramophone.

listed at 16 guineas. A similar receiver designed for battery operation, Model 77, is also shown.

Ultra Electric, Ltd., Western Avenue, Acton, W.3.

UNIRAD (18)

Unirad receivers hold special interest to the overseas listener, as all embody a short-wave range, whilst some are exclusively short-wave sets, and all are available built especially for tropical use.

A seven-valve all-wave AC superheterodyne is shown in tropical form for £32, and a battery type at £30. There is, in the range, a short-wave superheterodyne converter, which, complete with AC mains supply unit, costs £8

Union Radio Co., U.R. Works, Campbell Road, Croydon, Surrey.

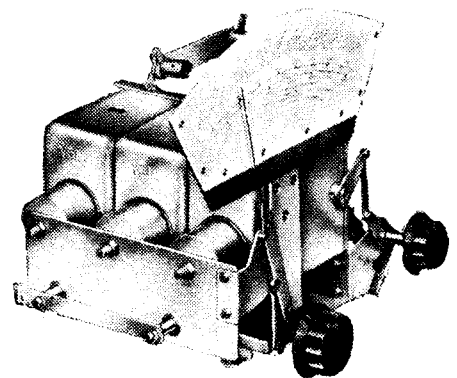

Varley Permeability Tuner.

**Complete Show Report—
VARLEY (31)**

Intermediate frequency transformers occupy a prominent position among the new apparatus shown by this firm. A transformer designed for operation at 465 kc/s and fitted with Litz-wound iron-core coils is on view, and it is provided with air-dielectric trimming condensers to increase both the efficiency and the stability of adjustment. Variband transformers, in which the coupling can be adjusted by means of a panel control for variable selectivity are also shown.

The advantages of permeability tuning in permitting constant selectivity and amplification are now extended to the super-

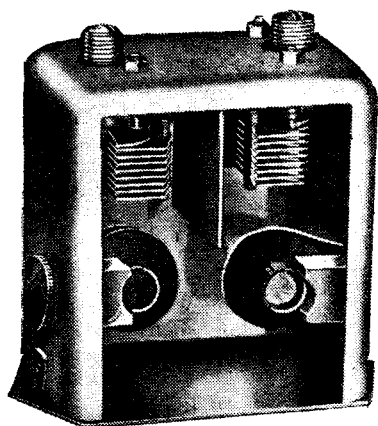

Varley Air-Tune IF transformer.

heterodyne by the introduction of three- and four-gang permeability tuners provided with padding coils for the maintenance of correct ganging in the oscillator section. The previously introduced models for straight sets are, of course, still obtainable.

The rest of the exhibit is devoted to a display of iron-core tuning coils, LF transformers, smoothing chokes, mains transformers, resistances and HF chokes.

Varley (Oliver Pell Control, Ltd.), Bloomfield Road, London, S.E.18.

VIDOR (98)

Not only does this exhibit consist of dry batteries for every conceivable wireless purpose, but a range of receivers is also included. Among these the CN222 is of particular interest in that it is an AC/DC set designed for all-wave reception; it is priced at 10 guineas and has four valves. A three-valve battery set of the all-wave type is priced at 8 guineas.

Vidor, Ltd., West Street, Enth, Kent.

W.B. (95)

The "Stentorian" range of loud speakers has been improved by the adoption of a larger permanent magnet of higher flux density, a new speech-coil former used in conjunction with an improved method of centring, and improvements in the method of interleaving sections in the "Microlode" output transformers which have resulted in an extension of the frequency range at both ends of the scale. Ivorine tablets giving the output settings for the leading makes of receivers are also included on the "Senior" and "Junior" models. The range consists of Types 36S (Senior), 36J (Junior), and 36B (Baby) at 42s., 32s. 6d. and 23s. 6d. respectively. There is also a midget speaker with 4in. cone and a three-ratio transformer at 17s. 6d. The "Senior" and

Next Week's Special Number**AUG. 23: REVIEW
OF THE SHOW**

This issue will contain a number of special articles by the technical staff of *The Wireless World*, based on a careful study and comparison of the new season's apparatus.

**REMEMBER OLYMPIA IS OPEN UNTIL
SATURDAY AUGUST 24th, 11 a.m. TO
10 p.m. DAILY.**

"Junior" models are also available in cabinets which have been specially lined to give acoustic properties designed to suit the characteristics of the loud speakers. These models are priced at 3 guineas and 49s. 6d. respectively.

From a technical point of view the most interesting development shown on this stand is the "Stentorian Duplex," which is fitted with a horn-type tweeter projecting through the hollow centre pole of the main cone magnet. Separate volume controls are provided for the two units, and the price of this new instrument, which should appeal to the experimenter, is 4 guineas. The tweeter is available separately at 2 guineas.

Whiteley Electrical Radio Co., Ltd., Victoria Street, Mansfield, Notts.

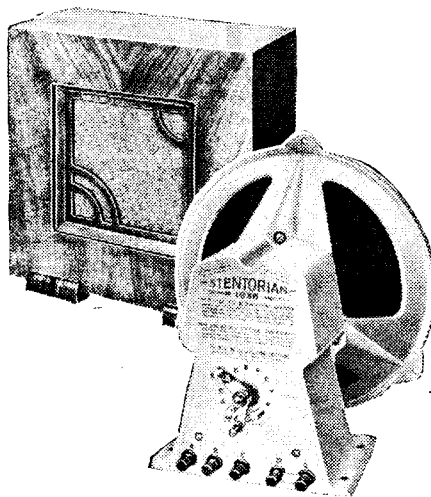

W.B. "Stentorian Senior" loud speaker.

WATERHOUSE (219)

The activities of this firm are devoted to the manufacture of radio furniture, their exhibit including tables and stands for most of the well-known proprietary receivers, cabinets and record cupboards. A special feature is a cupboard table in which space is provided for accommodating the set, also wet HT units of the Milnes style. This model costs £3 10s.

Frederick Waterhouse, Ltd., Ashwood Street, Dudley Hill, Bradford.

WEARITE (217)

The activities of this firm cover a wide field, and the apparatus displayed is correspondingly varied. A new air-core tuning coil is shown at the price of 5s.; this is the Unigen coil. There is a new range of iron-core coils and IF transformers, including the

variable-selectivity type used in *The Wireless World* 1936 Monodial AC Super. A range of plug-in short-wave coils is also shown, and there is a wave-trap coil designed for operation on both long and medium wavebands.

Testing equipment forms by no means a negligible part of the show, and it includes an oscillator covering a wide range of frequencies and provided with internal modulation. A multi-range meter unit permitting measurement of AC and DC voltage and current, as well as resistance, inductance, and

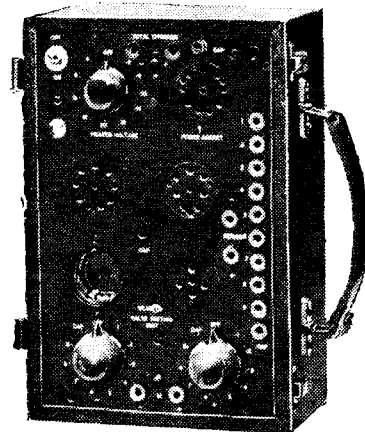

Wearite Valve Tester.

capacity should not be overlooked, and service men will be interested in the valve tester which is claimed to be applicable to any type of valve.

Mains transformers and smoothing chokes are also shown, in addition to a multitude of small components, including switches and HF chokes.

Wright and Weaire, Ltd., 740, High Road, Tottenham, London, N.17.

WESTINGHOUSE (101)

Rectifiers, and apparatus embodying rectifiers, form the exhibit of this firm. The well-known copper-oxide rectifier can now be obtained in forms suitable for almost any purpose. Low-voltage heavy-current types are available for battery charging, medium-voltage medium-current types for HT battery eliminators, and high-voltage low-current models for mains units which are

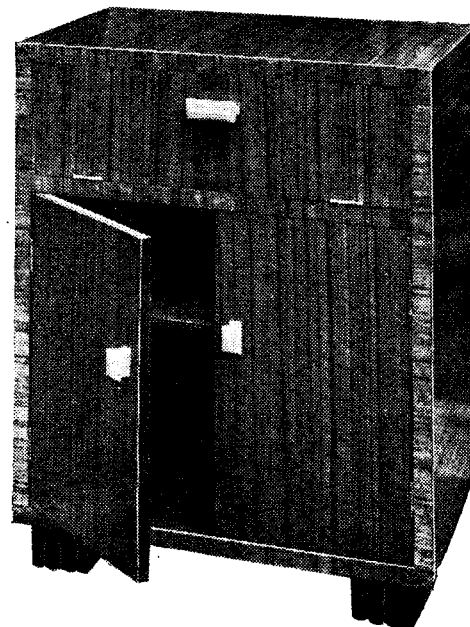

Waterhouse table cabinet.

Complete Show Report—

destined to provide the operating voltages for cathode-ray tubes. Miniature rectifiers, known as Westectors, are shown, and these have a sufficiently low capacity to function efficiently at radio-frequencies and are consequently of wide application in receivers. Other types find their way into AC voltmeters and milliammeters.

*Westinghouse Brake and Signal Co., Ltd.,
82, York Road, King's Cross, London,
N.1.*

WESTON (216)

The Weston Super Oscillator, model 692, is a new addition to the series of test apparatus made by this firm. Its frequency range is 100 kc/s to 22 megacycles (3,000 metres to 13.6 metres) and separate plug-in coils are used for each waveband. Internal modulation at 400 c/s is available fixed at 50 per cent., but external modulation can be applied if required.

Weston retains the Selective Analyzer in its original form for the new season, since it meets all present-day and near future demands; furthermore, this and the new oscillator together form a complete testing equipment for servicing and investigating the performance of every type of receiver.

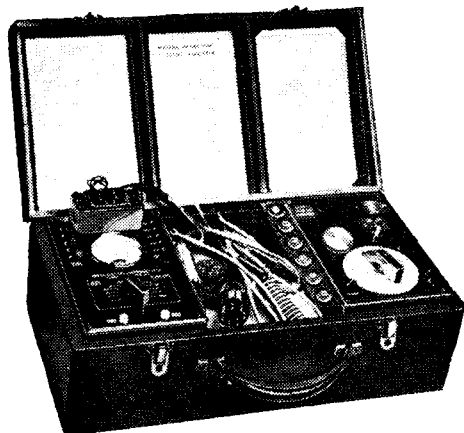

Portable servicing equipment made by Weston.

These two instruments are available in a neat carrying case, including all accessories.

*Weston Electrical Instrument Co., Ltd.,
Kingston By-pass, Surbiton, Surrey.*

WHARFEDALE (203)

Important technical developments in the Wharfedale range of loud speakers include the application of a new method of protecting the air gap from the ingress of dust and the introduction of a new type of exponential cone in the "Bronze" chassis at 35s., and the "Auditorium" chassis at 60s. for the DC energised model and 95s. for the permanent magnet model. The "Standard" and "Golden" chassis are being continued at 25s. and 50s. respectively. These prices do not include the output transformer, which can, however, be fitted in all cases for a slightly increased price. There is a wide range of extension speakers with or without transformer at prices ranging from 32s. to £5.

A late addition to this range is the "Queen Anne Cabriolet," which stands on legs and is fitted with the "Golden" chassis. The prices of this instrument are £8 without transformer and £8 15s. with universal transformer. All extension speakers are fitted with the Wharfedale

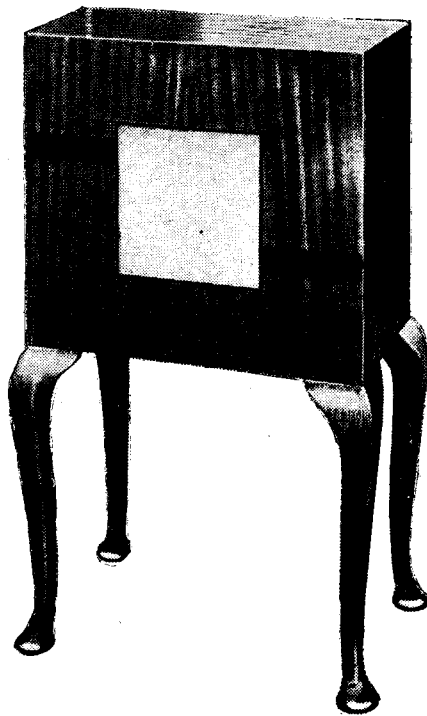

Wharfedale "Queen Anne Cabriolet" extension speaker.

"Truqual" volume control. Incidentally, it was noticed that all permanent magnet loud speakers on this stand were fitted with nickel-aluminium alloy magnets.

Wharfedale Wireless Works, 62, Leeds Road, Bradford.

Random Radiations

By "DIALLIST"

Car Radio Regulations

THE first draft of the regulations governing the use of radio sets in cars has just been issued by the Ministry of Transport for consideration by the various bodies concerned. So far as one can see, the suggestions seem to be thoroughly sensible and framed in the interests of safety. It is, for instance, proposed that the whole equipment, except the loud speaker, shall be contained in an earthed metal case; that no lead outside this case shall carry a voltage higher than that of the lighting battery (or the propulsion battery in electrically driven vehicles); that adequate fuses shall be provided between the set and the battery. One proposal which may meet with some opposition is that it shall be illegal to use a car radio set in built-up areas. As an old motorist I personally regard this as very sound. Traffic conditions in built-up areas are often such that the whole of one's attention must be concentrated on driving; a sudden outburst of music from somebody else's car might distract one at a critical moment, with unfortunate results.

John Tilley

BY the death of John Tilley, who rose from obscurity to fame in less than three years, listeners have sustained a very real loss. Comedians who can be really funny

in a perfectly natural way in the studio are few and far between, but Tilley was one of them. His was an astonishing career. During the war he obtained a commission in the Air Force, but, as he put it, two-thousand pounds' worth of smashed aeroplanes secured his transfer to the Gordon Highlanders. After the war he became a medical student without success. He lost a fortune of £10,000 left by his father and was by turns a paper merchant, a dealer in antique furniture, a bank clerk, a meat salesman and an advertisement canvasser. It was this last job which proved the stepping-stone to fame. His efforts to obtain an advertisement from the manager of a music-hall amused the latter so much that he offered Tilley a job just to walk on to the stage and be himself. In a matter of weeks he was the most popular of turns. Then the B.B.C. "discovered" him and he became a regular and popular feature of the broadcast programmes. Tilley wrote all his own monologues and his secret was just that he was natural. His death at the age of 36, just when success had come his way at last, was a tragedy.

Looking Forward

IT'S interesting sometimes to speculate on what broadcasting will be like when it achieves its silver jubilee 12½ years from now. In the 12½ years that have passed since 2LO, the original London station, first made its voice heard developments have been rapid. The number of stations in all countries has increased by leaps and bounds; continuous programmes lasting for twelve hours or more have replaced the old system of giving us nothing much during the day and three or four hours of good entertainment in the evening; the high-powered stations of yesteryear would be regarded as midgets to-day; relaying has been developed to such a point that one man can now speak to the entire civilised world; the quality of transmissions has been improved out of all recognition. To many people wireless broadcasting seems now to have reached such a state of perfection that there is little more to be done. But shall we not see in the second half of broadcasting's first twenty-five years' developments just as great as those of the first half? And, if so, what will those developments be.

A Prophetic Mantle

MY own feeling is that within a very few years we are going to see enormous changes. The long and medium wavebands are already so overcrowded that high quality reproduction is almost impossible unless the distance between receiving and transmitting aerial is comparatively small. If you don't believe me, borrow, beg, buy or steal a genuine high fidelity set and try it on stations other than your locals. You will find, I think, that you can make very little use of the response to the higher frequencies that is available. There is already a great and growing demand for "top," but you can't give the high notes full play unless there is something like a 15 kilocycle separation between the stations. At present we have a nominal 9 kilocycles, and as month follows month more and more problems of mutual interference arise on the wavelengths allotted to broadcasting. My own forecast is that the reproduction of the "sound" portion of television broadcasts on the ultra short waves by means of first-rate receivers will come as such a revolution to listeners that within ten years the bulk of broad-

Random Radiations—

casting in all countries will be conducted on wavelengths below 10 metres. Most of them will retain a certain number of long-wave or medium-wave stations for the purpose of covering areas that cannot be reached by the ultra-short; but after the peak point has been reached in two or three years' time the number of long-wave and medium-wave stations will decrease rapidly.

Another Mystery Ray

THE American Naval authorities have been conducting experiments with some form of radiation which is naturally dubbed a mystery ray by the lay Press. So far as one can make out, what has been done is to produce an invisible focused beam, by means of which enemy vessels can be located and guns trained on them at long ranges in the dark. During the experiments the apparatus was installed in a lighthouse, a searchlight projector being made to move with the beam, but the light itself not being switched on until the observers reported the target located. The searchlight beam thus represented the path of an imaginary projector. At a range of 5 miles "direct hits" were scored nearly every time.

What Is It?

One wonders whether the radiations used are above or below the scale of visual frequencies. Neither ultra-violet nor infra-red rays are visible to the eye, though both can be made visible indirectly. Objects illuminated by X-rays, for instance, can be seen by means of the fluorescent screen, whose action may be compared with that of a detector of a wireless set. The detector converts radio frequency oscillations, which are far too rapid to affect the ear, into oscillations within the audible scale; a fluorescent screen, similarly, emits visible rays when bombarded by those whose frequency is far too high for the eye. Infra-red rays cannot be detected by fluorescence since their frequency is already too low for the eye, and fluorescence always means a

reduction in the frequency. The only known means of making them visible is the use of a special camera plate. Detection could be done on much the same lines as the delayed method of television, though the necessary lag of some 30 seconds would make searching with a beam very difficult. Infra-red rays have the advantage of penetrating fog or falling snow, either of which would render the ultra-violet completely useless.

Another Dance Band Storm

DANCE music, I see, has been the subject of yet another smashing attack by no less a person than Harrow's Director of

Music, who classes certain types of syncopated music as exotic and pernicious. This has made the dance band leaders get up on their hind legs, and the warfare continues. As Mr. Harry Roy rather neatly put it, if dance music were altogether bad, then 100,000,000 people must be wrong. Myself, I have no great objection to dance bands as dance bands if only they won't croon—crooning I do regard as one of the nastiest noises that the ingenuity of man has yet been able to produce. Though I seldom tune in dance music deliberately I can listen to a certain amount of it when I am in the mood. It does, though, strike me as being, on the whole, monotonous and singularly lacking in good tunes.

DISTANT RECEPTION NOTES

THOUGH at the time of writing we are still enjoying hot dry summer weather, American stations are coming in remarkably well on nights when atmospheric conditions are not too severe. It is a rather curious fact that for 18 months or more by far the best part of the medium waveband for American stations has been that which lies between about 220 and a little over 300 metres. Some years ago reception was good on wavelengths up to at least 470 metres. One used to be able to hear stations such as KFI of Los Angeles, WEAJ of New York, KPO of San Francisco and WLW of Cincinnati. But during the last two winters I have heard very little above 300 metres, and I think that the same applies to most listeners who try for medium-wave transatlantic stations. Those which are best heard at the present time are WCAU Philadelphia on 256.4 metres, WPG Atlantic City on 272.6, WTIC Hartford on 288.3, and WBZ Boston on 302.8. Others are to be found on occasion on somewhat shorter wavelengths; we have thus a good band between 220 and, say, 305 metres, with a specially good portion from 250 metres upwards.

Speaking of American stations leads me to wonder how many less experienced seekers after American stations have been misled on hearing the call sign for which they have been waiting by the American habit of pronouncing Z as Zee. To our ears it sounds just like C, and if you don't tumble to the fact that it is really Z much fruitless searching of station lists may ensue.

Mr. Royal, the Vice-president of that huge American chain, the National Broadcasting Company, has been spending some time in this country, and it is expected that one result of his visit will be frequent programme exchanges between this country and the United States. The N.B.C. controls about 120 stations in the northern part of the United States, and the authorities find that their listeners approve highly of the British programmes that they have so far been permitted to hear by means of relaying. In this country American relays have also proved popular, and it is good news that we are likely to have more of them.

Probably because it is so far away and we hear so little of it in the news, many people think of Iceland as a very small country. Actually it is a good deal bigger than either Scotland or Ireland—bigger, in fact, than Denmark, to which it belongs. At present it has only one broadcasting station, Reykjavik, which has rather an unhappy wavelength partnership with the 35 kilowatt Russian station Minsk. Reykjavik's 16 kilowatts have proved quite inadequate to give a proper service to a mountainous and rather thinly populated country. It is therefore proposed to increase the power during the coming 12 months to 50 or even 100 kilowatts. When Reykjavik first came into action some little time ago it was fairly well received in this country; but for some considerable time it has hardly been heard, except possibly in the more northerly parts of Scotland.

Poland is to add another station of moderate power to her team. It will work on 224 metres and probably have an output rating of between 2 and 3 kilowatts. The site of the station does not appear to have been selected yet.

Finland is erecting two new transmitters. One of these is to replace the present 1.2 kilowatt plant at Oulu. The power used at present is 1.2 kilowatts, but the new plant will be rated at 25. The wavelength is 696 metres. The second is an entirely new station to be built at Vasa. The output is given as 10 kilowatts and the station will have to share a wavelength since no individual channel is available. D. EXER.

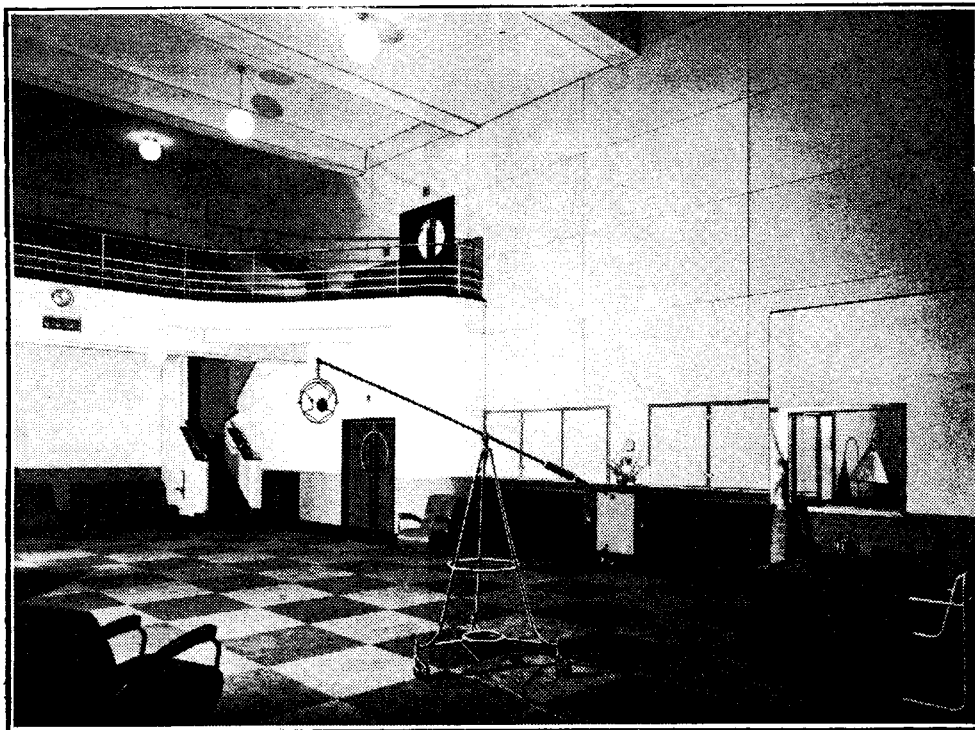

The New Large Studio (No. 1) at Broadcasting House, Manchester.

CURRENT TOPICS

EVENTS OF THE WEEK IN BRIEF REVIEW

Radiolympia

ANTI-INTERFERENCE measures are among the big features of the Show. The importance of quelling man-made static has never before been brought into such prominence at a British radio exhibition.

No one should miss Stand No. 80, which is virtually a consulting room for all listeners troubled by electrical interference. The stand has been jointly organised by the R.M.A., G.P.O., E.R.A., and the B.B.C.

A large number of American visitors are expected this year. Guests from abroad are specially welcome at Stand 52, organised by the Department of Overseas Trade.

The biggest "sideshow" in the Exhibition is the Post Office village, which includes a section devoted to means for combating electrical interference. Another interesting attraction is an office from which radiograms can be transmitted free to ships at sea.

King Bans Static

THE only broadcast receiver in the Hedjaz is owned by King Ibn-Saud, who is an ardent radio amateur. On this account he is all the more perturbed by the static created by ships passing through the Red Sea, and has now issued a State decree forbidding all ships to utilise wireless in the Hedjaz waters.

It remains to be seen whether His Majesty, emulating a former monarch of history, will be able to suppress the waves.

Television is Star Feature of Berlin Show

THE world's first "Television Street" is a feature of the Berlin Radio Exhibition, which opens to-day, August 16th. On both sides of the "street" six leading television manufacturers are demonstrating reception of the day's programme from the Post Office station. The whole of the television section is in a darkened hall.

In addition to the home television receivers, displays for large audiences are being shown on a 10,000-lamp screen, while in a small theatre a full-size cinema screen is being used to demonstrate television with intermediate film.

The television arrangements are not affected by the new Government decree placing television under the control of the Air Ministry. Close watch, however, is being kept on all transmitting gear, television now being part of Germany's national defence equipment.

This year's radio exhibition is the largest yet held in Germany, occupying a third bigger area than the 1934 show.

Chain of Studios

ROUMANIA, although her broadcasting stations are limited in number, is determined to appeal to every part of the country by installing broadcast studios in all the principal towns, each with a special line to Bucharest.

220 Kilowatts for Finland

LAHTI, Finland's principal broadcast transmitter, is to be made the most powerful in Europe, with an aerial output of 220 kilowatts.

Sun Spoils Radio

THE Polish broadcasting authorities are engaged in a campaign to popularise summer wireless as the number of listeners shows a falling-off during the hot season. Propaganda, both printed and broadcast, is continuing at high pressure, and the radio industry is being urged to produce inexpensive summer sets. Prizes are offered to listeners who induce others to take out licences.

As a correspondent remarks, if only the sun could be switched off the rest would be easy.

Pirates' Paradise

FRANCE is overrun with radio "pirates," according to the French National Federation of Broadcasting. In an official statement the Federation declares that "whereas the number of licensed listeners in Great Britain exceeds a figure of six millions out of a population barely superior to our own, this country does not attain one-third of the number."

The Federation, believing that the discrepancy is attributable to the large number of French listeners evading payment of the tax, appeals to their morality and sense of duty.



STOP! A Brighton policeman photographed on point duty last week while picking up an official message on his pocket wireless receiver.

More Power for Radio-Paris

RADIO-PARIS is to be used for international propaganda. Last week M. Mandel, the French Postmaster-General, announced that the power of the station is to be considerably increased so that it will be audible not only in France "but beyond our frontiers." Radio-Paris already works on a power of 80 kilowatts.

The Colonial station is to have two transmitters of 100 kilowatts, considerably in excess of any other short-wave station in Europe.

Short-wave Listening Contest

A SHORT-WAVE listening contest extending from September 1st to November 30th next is being organised by the International Short-Wave Club. The contest concerns broadcast reception only, and two months will be allowed after the closing date of the contest for competitors to receive verifications from the more distant stations.

Full particulars of the contest and of the prizes offered can be obtained on addressing an enquiry to: I.S.W.C. DX Contest, 82, High Street, Clapham, S.W.4. A halfpenny stamp should be enclosed.

The 1936 Monodial AC Super

IT is regretted that an error occurred in the practical wiring diagram of this receiver which appeared on page 100 of *The Wireless World* for August 2nd, 1935. The connections to the grid and anode sockets of the ML4 valve-holder have been interchanged in this drawing.

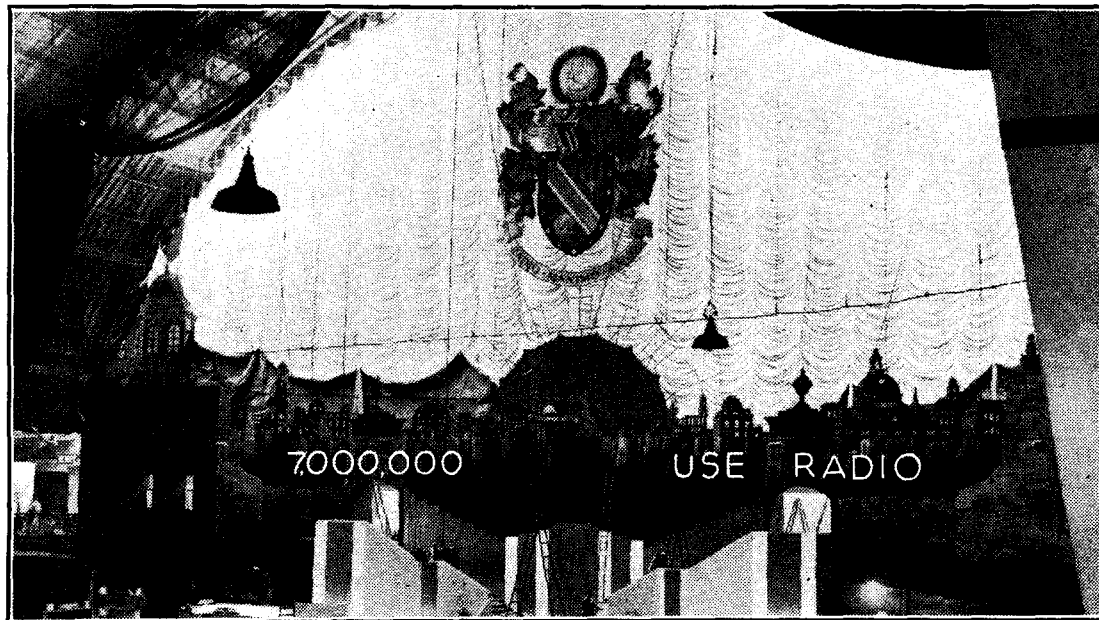

CLEARING THE DECKS AT OLYMPIA. An eleventh-hour picture taken at Radiolympia before the official opening which took place on Wednesday, August 14th. The striking façade, picked out in neon lights, shows London's skyline surmounted by radio and the crest of the R.M.A.

Lost Milliwatts

How Various Forms of Distortion are Related

By M. S. GRAHAM

IT is shown in this article that non-uniform amplifier characteristics are responsible for more than distortion. Even if the departure from the ideal "straight-line" response curve is too small to be appreciable by ear, it will nevertheless reduce the average output that would otherwise be obtainable from the receiver to a considerable extent.

WHY is it that one never seems to be able to get so much *clean* volume from records as from radio? The difference may not always be noticeable, but taken on the whole the experience is that when a receiver is being used with a gramophone pick-up its volume-handling capacity seems to be less than when it is reproducing the local-station programme.

I say *local-station* programme, because if the receiver is of the I-HF type with reaction a somewhat similar apparent loss of milliwatts occurs when it is used on a distant station.

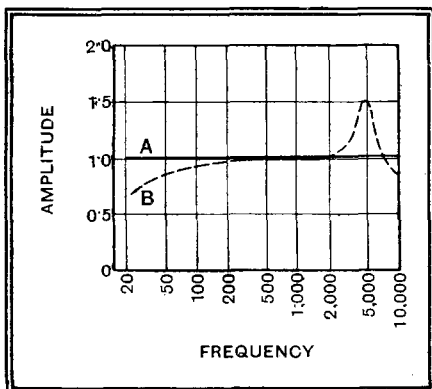

Fig. 1.—An ideal response curve compared with one having a pronounced peak as about 5,000 c.s.

Now, this matter is in a region where half-truths float about and obscure the outlook. I believe the conventional explanations of the above-mentioned effects are related to the truth, but by themselves are misleading.

We are generally told that reaction accentuates the low tones, or cuts the sidebands (two ways of looking at the same thing), so causing distortion. Some, with even less understanding of the problem, might say that the volume from a distant station is less because there is not enough amplification to bring it in more strongly. That, of course, has nothing to do with the premature overloading I am talking about. And as regards gramophone reproduction, most people seem reluctant to notice the defect, or else ascribe it vaguely to pick-up distortion. But that either of those conditions should cause the set to overload at a lower level of volume than

when local radio is being received does not seem to follow very logically.

In the efforts to approach perfect reproduction, much importance has always been attached to level-frequency characteristics—towards ensuring that amplifiers, loud speakers, pick-ups, etc., should respond equally at all audible frequencies. The obvious reason is that the original frequencies ought to be represented in their true and original proportions without accentuation or loss of bass, treble, or any other part of the scale.

It is quite a good reason up to a point; but after the grosser defects have been eliminated, the listener is exceedingly inappreciative of more refined progress. Seeing that even an expert cannot detect a hump or peak of the order of 50 per cent. over any part of the scale simply by listening to a programme, and, moreover, that modifications greater than this are caused by acoustic and other effects outside the equipment altogether, this is not surprising.

Why Level Output ?

The more important reason for desiring strictly level output is so often obscured that it may be news to some readers. It is easy to understand it by looking at some imaginary frequency characteristic curves in Fig. 1. A is the ideal "straight line" of fiction. B is quite a typical

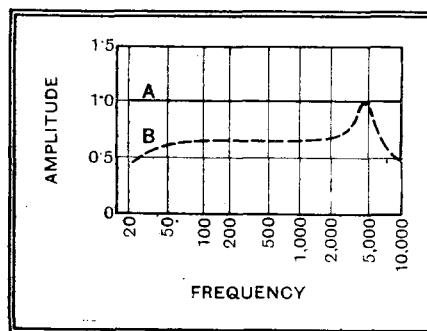

Fig. 2.—Showing the limitations in general output level resulting from a peaked response.

curve for, say, an intervalve transformer; it nowhere departs so far from A as to be easily distinguishable from it by ear, judging on the basis of balance of tone.

But now consider what happens in the power valve, which can handle a certain amount of volume comfortably, beyond which a very small increase causes grievous distortion. Note that even if the limit is exceeded only at one small part of the frequency scale, all the rest is messed up by and with it. Suppose A represents this limit. Then full strength "signal" currents of the frequency at which there is a peak exceed the limit and spoil the whole. To avoid this it is necessary to turn down the volume control until the peak stands no higher than A (Fig. 2).

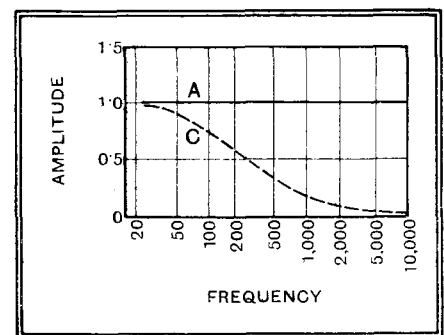

Fig. 3.—The effect of applying reaction

Nearly the whole of the musical scale is then reproduced at half strength, and the average volume is therefore little better than this. What actually happens, of course, is that in attempting to get full normal output the condition of Fig. 1 is realised; result, fuzzy reproduction.

I did not at the time refer to curve B as a typical gramophone pick-up characteristic, because you would have been so busy protesting that pick-up curves generally have a big rise in the bass instead of the droop displayed by B that my argument would have been side-tracked. Actually, the rise shown in published curves is often largely a fictitious one, due to a disproportionate response when test records with abnormal bass track amplitudes are used. And in any case what rise there may be is more than nullified by the deficiencies of ordinary bass recording. Many pick-ups have much worse peaks than has curve B, and the reduction in useful volume is severe, even allowing that recording at the peak frequency may rarely reach the maximum.

Effect of Reaction

The situation when reaction is used for radio reception has several complications. Detector overloading is one probable trouble. It involves distortion certainly, but is more noticeable as loss of amplification. But that is another story.* It is

* See "Detector Saturation," *The Wireless World*, August 24th, 1934.

Lost Milliwatts—

an avoidable one, too. Regarding reaction as an upsetter of the frequency characteristic, the features are, first, that the rise in the curve may be very large, and that it grows towards the extreme bass (Fig. 3, curve C).

The very low frequencies are present in many programmes at relatively large amplitude, so that when exaggerated by reaction the limiting effect on undistorted output from the power valve is dire. On

the other hand, however, those low notes are relatively very poor in audibility. So what we have is an output of which the only constituents that are present in any strength are just those to which the ear responds least. That should explain very completely the difficulty in getting anything like full undistorted volume when much reaction has to be used.

Looking at it more broadly: departures from "level" amplification noticeably upset the balance of tone only when they

are quite severe. But even a moderate departure is liable to restrict the number of milliwatts that can be painlessly extracted from the receiver. If the power valve is capable of giving 3,200 milliwatts "undistorted," and one of the preceding links in the chain has a peak rising to double the general level (in volts), the valve may be little better than one rated at 800 milliwatts, which, of course, could be fed more cheaply. It is worth thinking about.

Broadcast Brevities

By Our Special
Correspondent

Good Boys All

MORE B.B.C. promotions! Vice-Admiral Sir Charles Cappendale, on October 1st, becomes Deputy-Director-General, and Mr. B. E. Nicolls succeeds him as Controller.

Although, of course, we do not read in the newspapers of all the other changes which these promotions entail, it is worth remembering that everybody at Broadcasting House will, in effect, "go up one" in October. I hear that the official mouse-catcher is now taking lessons in rattling.

R.M.A. Restraint

LEONARD HENRY, Tommy Handley and Stanelli are, I hear, among the popular comedians who will act as sidesmen at the religious service to be held in the theatre at Radiolympia on Sunday next at 8.30 p.m.

I am told there will be no sideswomen, which shows a certain amount of restraint on the part of the Radio Manufacturers' Association.

B.B.C.'s Attitude

The Rev. Oswald Brenton, B.A., vicar of All Souls' Church, Langham Place, has composed a special prayer of thanksgiving for the B.B.C. and will, I understand, preach a "radio" sermon. Gibson Young will conduct well-known hymns by the Radiolympia Choir, supported by Sydney Baynes' Orchestra and Callender's Band.

The B.B.C. has, however, declined to broadcast the service, and Mr. Iremonger, the B.B.C.'s religious director, will not be present.

The "D.G.'s" Holiday

SIR JOHN REITH, is, I understand, about to embark on a yachting holiday, a form of recreation in which he has not hitherto indulged.

Incidentally, the "D.G." will be in constant touch with the B.B.C. programmes, although he may be tempted to range further for ether entertainment, as the yacht set is an all-wave one.

Cat Out of the Bag

I AM hourly expecting protests from the animal protection societies of the Empire. For too many years they have accepted the B.B.C. time signal without considering how it is produced; or, if they have meditated on the point, they have ascribed to the pips a vegetable origin.

Never have they guessed that the creator of the pips—or perhaps we should now say "squeaks"—is a harmless domestic animal.

How It Is Produced

Says a B.B.C. news letter to Empire listeners: "Imagine," said the B.B.C. engineer, 'a cat in a box. The cat is howling.

Harrowing

Possibly this is just a piece of cold-blooded imagery, but does it not ring true?

By the way, the time signal still is much abused by musical fanatics who seem to consider that an uninterrupted rendering of the "Moonlight Sonata" is more important than the setting of chronometers at sea.

Orchestral Mystery

AFTER years in cold storage an interesting secret is disclosed by the B.B.C. arrangements for August 22nd next.

In the National programme at 8 o'clock on that night we have the Promenade Concert by the

where does Sir Henry Wood get his go?

Here is a problem worthy of "Free Grid's" mental calibre.

"Outsiders"

Do a number of the players dart to and fro between the Big House and the Queen's Hall, playing in the studio concert in the intervals of the Promenade Concert, or vice versa?

This I could not believe, but by dint of close questioning I have wrested from a B.B.C. official the intelligence that "outsiders" are imported on special occasions to make up the full complement of players.

Orchestra-Mad?

This strengthens my growing suspicion that the B.B.C. is becoming orchestra-mad. To import players for a studio orchestral concert while another and better concert is proceeding on the other side of the street suggests extravagance, to say the least.

But why say the least, when it is your money and mine that is being juggled with in such a droll fashion?

A B.B.C. Conductor's View

B. Walton O'Donnell, conductor of the B.B.C. Military Band, who is now absent on holiday, has always refused to import casual players to his band. He maintains that a military band is more sensitive to changes in composition than an orchestra, and that the players must be welded together as a unit by long association if a perfect combination is to be achieved.

And Now—Hungary

THE B.B.C. has not been left long to enjoy the satisfaction of being the only broadcasting organisation with a film all about itself. A friend writes that "Hallo Budapest!" is the title of a new Hungarian screen production setting forth the activities of the Radio Budapest and featuring all the radio stars.

And there are three hundred Dancing Daughters.



IN TOWN TO-NIGHT. The American National Broadcasting Company is not afraid to take the microphone into the streets. This picture was taken on a Saturday night in the Bowery district of New York. Jerry Belcher, N.B.C. reporter, is interviewing passers-by.

The lid of the box is connected by an electrical circuit, as it were by a string, to the main clock at Greenwich. There, by means of a special wheel attached to the clock, six impulses act like jerks on the string every fifteen minutes, lift up the lid of the box, and let out poor pussy's howl. So the familiar time signal, six staccato pips, is produced.

"The signal from Greenwich lets out the constant howl of the imprisoned cat and produces the much abused, much used, indispensable Greenwich time signal."

B.B.C. Symphony Orchestra of ninety players. The relay ceases at 9.30, though the concert continues until 10.30 or thereabouts. Yet at 10 p.m., incidentally on the same wavelength, the B.B.C. offers, by way of novelty (?), "an orchestral concert" in the studio by Section C of the B.B.C. Symphony Orchestra, which consists of forty players.

Fully mustered the B.B.C. Symphony Orchestra numbers 114 players. When Section C is playing in Broadcasting House,

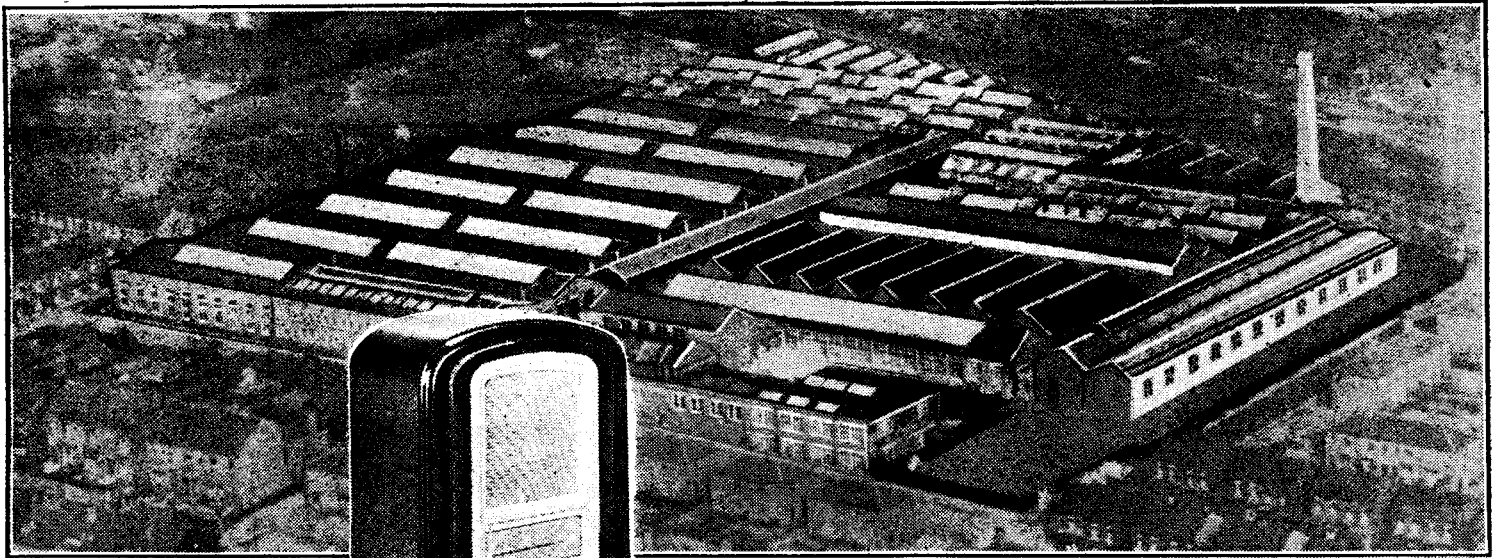

The Receiver Through the Factory

HOW YOUR SET IS MADE : FROM RAW MATERIAL TO THE FINISHED PRODUCT

THE efficiency, reliability and moderate price of modern receivers are largely the result of recent improvements in manufacturing methods. This article is intended to give the layman some insight into the processes and organisation involved.

FEW people outside the industry realise the extent of the changes which have taken place in manufacturing methods during the last decade. At a time when new valves and circuit developments were appearing with such rapidity that few makers had the courage to lay down more than a dozen

or so sets at a time, one always spoke of "the wireless trade"—and with some justification, for the set manufacturer bought his components ready-made, employed a few hands to screw them to a baseboard and wire them up, expected his designer to undertake the testing, and sold them in a polished mahogany cabinet

at a handsome profit. An order for a gross resulted in the truthful announcement of "Year's output sold on first day of Show."

Those days are past, and we now naturally refer to the "radio industry"—for such it has become, with vast new factories, specially designed and laid out

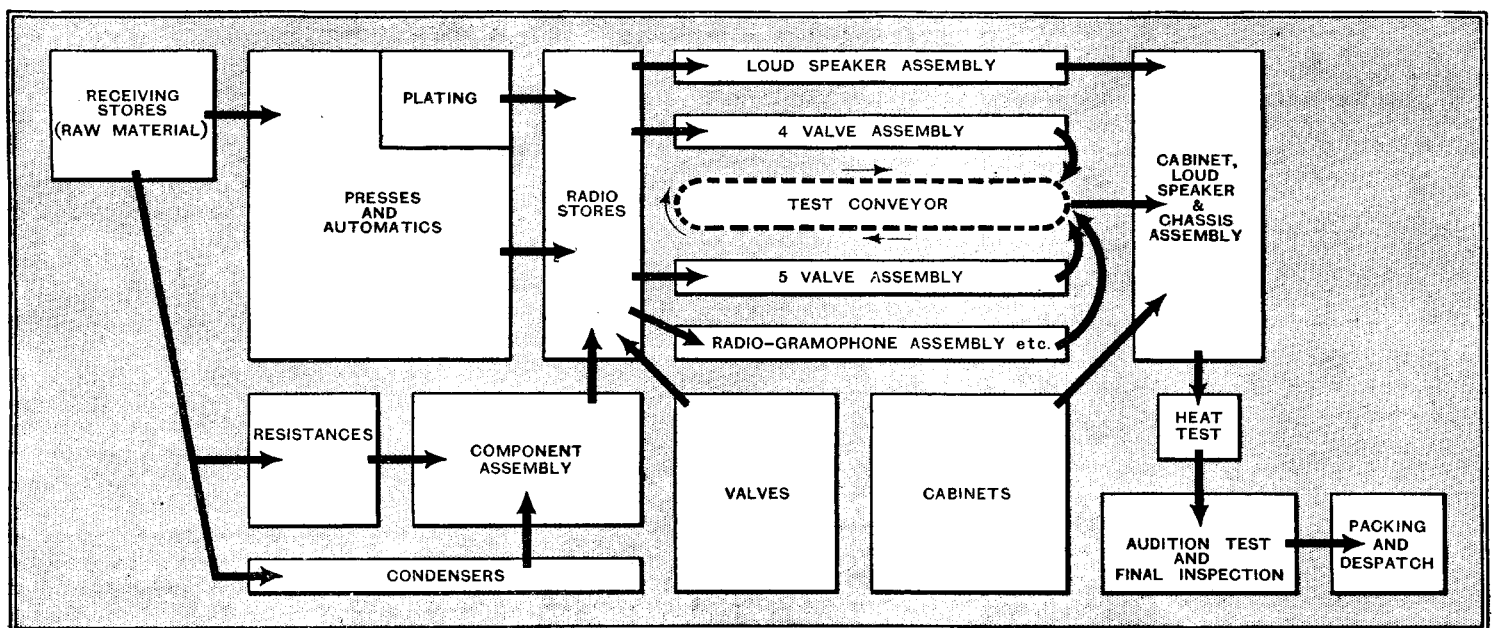

Schematic diagram showing the sequence of manufacturing processes. The layout does not necessarily agree with the architectural plan of the works.

The Receiver Through the Factory—

for producing in thousands sets the design of which is unlikely to be changed for a twelve-month, and then only in

driven by independent motors. In addition to allowing scope for rearrangement this also eliminates the maintenance of shafting and overhead countershafts.

Component parts are assembled on long parallel benches leading down to a conveyor which takes the HF and IF coil assemblies, etc., already approximately

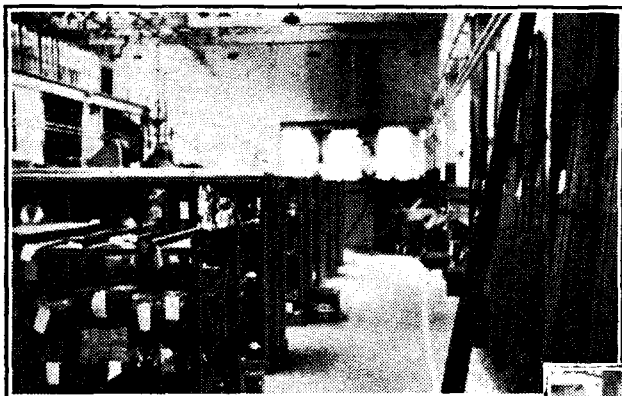

(Left) Receiving stores for raw materials. (Right) Automatic cadmium plating plant. (Below) A battery of light presses in the machine shops. Note the independent driving motors.

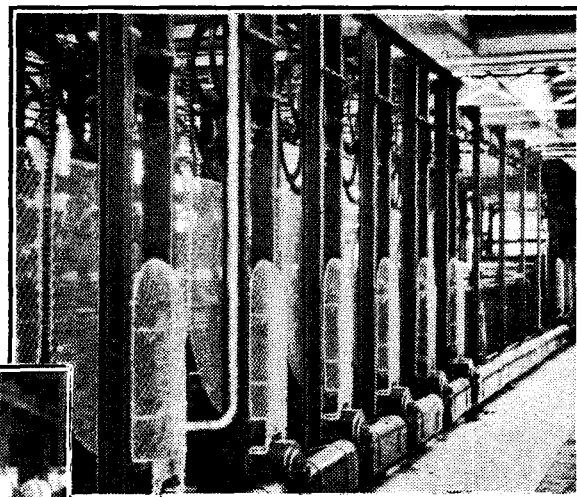

detail. What we have lost in individuality and variety of treatment has been more than balanced by a phenomenal increase in the value-for-money represented by the modern set, while the stability essential to quantity production is steadily overcoming the problem of obsolescence and the second-hand value of sets.

Some insight into modern methods of manufacture will be gained from the following description of the Ferranti organisation, which, having outgrown its section of the main Hollinwood works, has just started *carte blanche* in new premises at Moston, Lancs. In the main it is typical of the organisation of the modern radio factory, though it is probably unique in that valves and loud speakers are included among the components manufactured under one roof.

The tour started logically in the Receiving Stores, where raw material is stocked for re-issue to the various departments. This Stores is adjacent to the machine shops, and the bulk of the material is in the nature of brass rod for screws, metal sheet for coil cans, etc. There are also insulating materials, including interleaving papers, varnishes and



Here nuts, screws and spindles are turned out by the automatic lathes, while coil cans, laminations, switch contacts, etc., are produced by the automatic toggle presses. A huge automatic cadmium-plating plant has just been installed in which a chain conveyor takes the chassis parts through cleaning and washing baths, and, after passing at a regulated speed through the plating vat, finally dries the products in a hot-air oven at the far end.

trimmed, to the radio stores, from which parts are reissued to the main assembly lines. On adjacent benches connecting leads are cut to length and the ends tinned, and another section, equipped with pneumatically operated presses and electrically driven sensitive drilling machines, is devoted to the manufacture of small parts associated with the tuning scale, etc.

The condenser department, in which both electrolytic and paper dielectric types are made, is notable for the precautions which have been taken to exclude dust and moisture. A large glass-house has been built under the main roof and the air supplied inside is filtered through oil-impregnated screens. No food may be taken inside this department, and the girl operatives are forbidden the use of face powder.



(Left) One of the component assembly lines devoted to HF coil winding and adjustment. (Right) Vacuum impregnating ovens in the condenser department. (Below) Electric drills and pneumatic presses in the small components section.

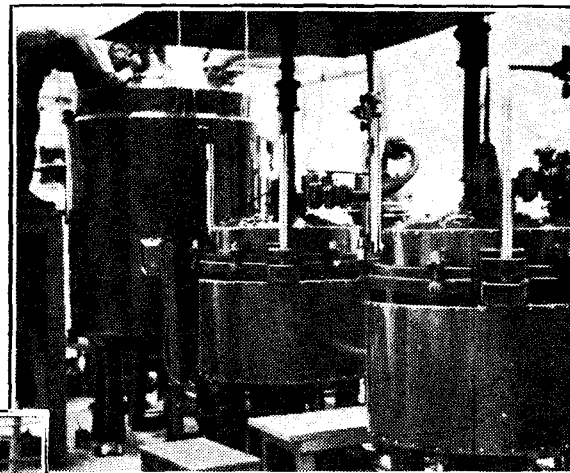

loud speaker cone dopes, bakelite powder and insulating sleeving.

The adjacent machine shops are carefully laid out and there is none of the congestion which is often seen in this department. There is ample space between the long lines of machines, which are each

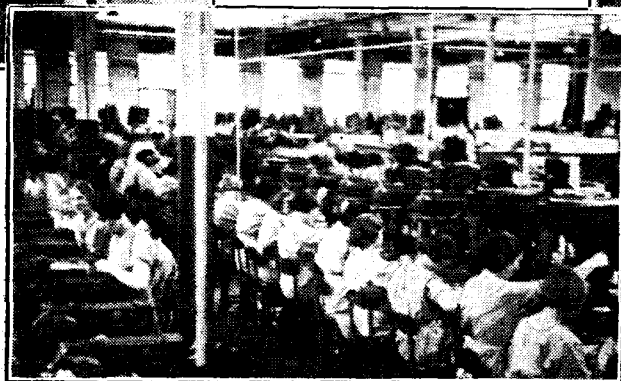

A certain element of secrecy surrounds the methods employed for producing electrolytic condensers, and the rolled paper dielectric condensers are also turned out by machines of a special design. The latter type are impregnated in vacuum ovens and slowly cooled off to prevent crystallisation of the wax and the absorption of water.

Ferranti fixed resistances consist of a porcelain rod covered with an exception-

The Receiver Through the Factory—

ally hard film of carbon which is deposited in an electrical furnace in an atmosphere of benzine vapour. The fur-

the resistance while it is actually in the lathe, and the operator continues the spiral cut until the needle reaches the exact value required. Finally, the resist-

removed by a belt sanding machine which carries an endless abrasive belt running at high speed. The cabinets are then stained and polished, and, after being stored for some time to allow the varnish to harden, are placed on an overhead conveyor which takes them to have their loud speakers fitted at the end of the main assembly line.

Resistance Making. (Right) One of the automatic electric furnaces for depositing the carbon surface. (Below) Spiral grinding machine for adjusting resistance value.

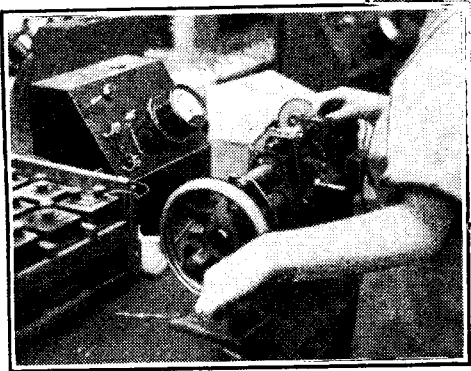
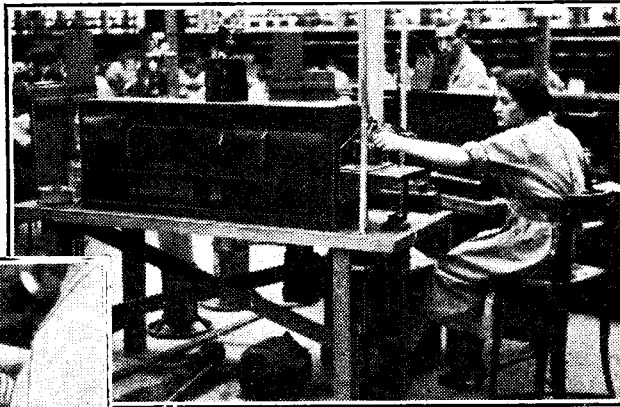

nances are continuously operating and the rods, which are fed in at one end by hand, are moved slowly through the tube by mechanical means. The resulting deposit is so hard that it is difficult to touch it with a file. After capping, the resistance elements are placed in a kind of screw-

ances are cellulose sprayed, re-checked and coded before being issued to the component and main assembly benches.

The loud speaker department has been placed next to the main assembly lines in order that the finished speakers may meet the chassis at the end of the line. A conveyor belt is used in this department, and the first item to be placed upon it is the cone support casting. At the head of the line is a machine which winds magnet coils with waxed paper interleaving five or six at a time. When finished these are parted off and placed on the conveyor, where they are assembled in the cone housing. The speech coils are hand-wound and the fitting and doping of the cone are also hand operations calling for special skill. After final assembly, includ-

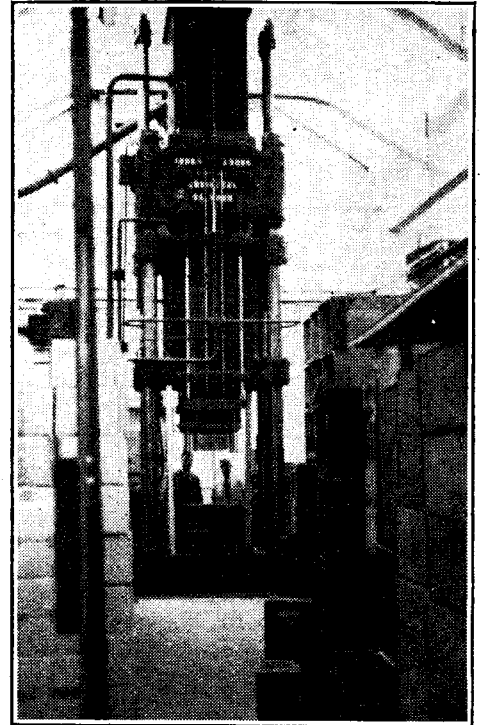

The 750-ton cabinet moulding press.

The valve department is one of the most interesting and is obviously organised with great efficiency. On commenting on this to our guide it was pointed out that the valves *have* to be right as there is no one else to return them to if any trouble should arise. The glass-work is carried out on rotary machines

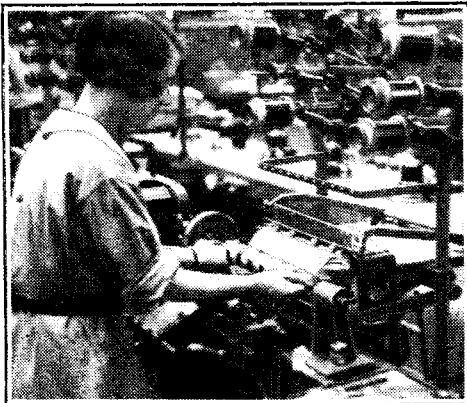

Removing a batch of loud speaker field coils from the automatic coil winder.

cutting lathe, and a spiral groove is cut with a knife-edge grinding wheel to increase the resistance to the required value. A direct-reading ohmmeter in connected to

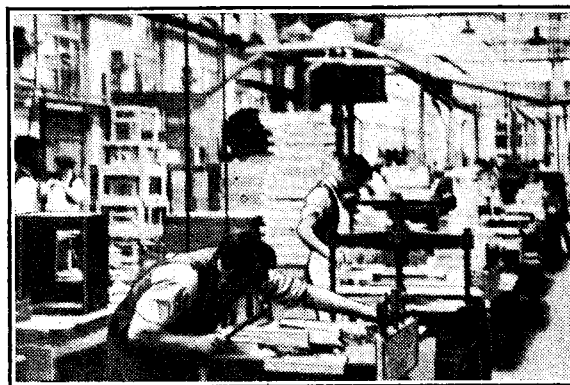

(Above) Assembling wood cabinets in clamp jigs. (Right) Belt sanding machine for removing rough corners and excess glue.

ing the output transformer, each speaker is given a frequency-response test and an aural test under working conditions before it is fitted into the cabinet, when it is again tested to see that no buzzing noises have developed during this operation.

The cabinet-making department is one of the largest in the works and includes a 750-ton press for the manufacture of bakelite cabinets. The component parts of the wood cabinets are shaped and planed in a machine shop employing the latest type of high-speed woodworking machinery. After assembly in clamp-jigs the rough corners and any excess glue are



Doping the apex of the loud speaker cone to increase high-note response.



The Receiver Through the Factory—

with gas jets regulated at each point to bring the glass slowly up to the fusing point and then to cool it gradually to obviate cracking. The grids and anodes are turned out by semi-automatic

is a general clearing house for the products of all the various component departments. Here "kits of parts" are placed on the conveyors passing down the parallel general assembly lines, each of which is devoted to a different type of chassis.

Every operation is timed to ensure a steady flow along the line, and sectionalised coloured diagrams opposite each girl indicate the precise nature of the work she is required to perform. Before being allowed to take a place on the assembly line every operative must complete a course in the work's own Soldering School. Starting with simple



Spot-welding the electrode supports and connections.



(Above) Staining and polishing department. (Right) A batch of cabinets on the overhead conveyor leaving the cabinet department.



machinery and are chemically cleaned and freed from a large proportion of their occluded gas in hydrogen and vacuum furnaces before assembly. During this process they are handled with forceps and must not be touched by hand. The electrode assembly is then sealed into the bulb and exhausted by another rotary type of machine fitted with high-frequency induction coils for heating up the interior metal parts and also for firing the "getter," which chemically removes the last trace of gas after pumping. The bases are then cemented to the bulb and the leads soldered to the pins. After storing for some time to allow any incipient leakage to show itself the valves are given what is known as a "rotary age test." A continuously operating machine has been specially designed for this, and is a great improvement on the older "rack" method of ageing and testing. All the essential constants of the valve are measured before it is passed out, and in the case of frequency-changer valves there is a special high-frequency test.

exercises designed to form judgment as to the amount of flux required for different types of joint, the control of heat flow, etc., the pupils finally reach the stage where they can perform any operation on the current models in production.

When it leaves the store the chassis is fitted only with valve holders, and the first few places on the assembly line are devoted to the fitting of top components such as the HF and IF coil units, gang condenser, and mains transformer. The

the assembly lines, and is flanked on both sides by testing benches. Each testing unit is self-contained and is fitted with an output meter adaptable for triode or pentode valves, a monitoring loud speaker, and an input attenuator. Modulated HF at the IF, three medium-range, and two long-range frequencies are fed to each bench through screening conduits from a central high-powered signal generator. Coloured identification discs are attached to the set as each test is completed, and the chassis circulates on the conveyor

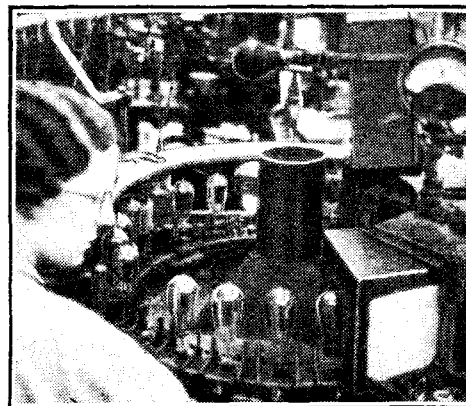

Exhausting machine. The final trace of gas is removed by igniting a small quantity of magnesium inside the bulb by means of a high-frequency induction coil.

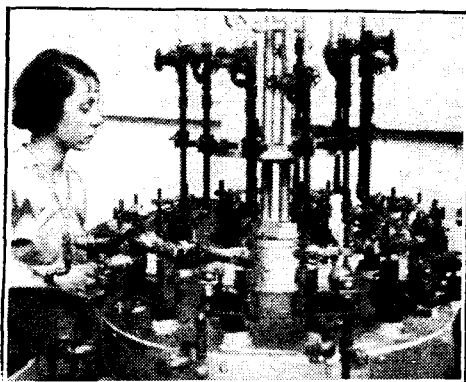

(Above) Rotary machine for forming valve pinches. (Left) Vacuum furnaces for extracting gas and cleaning electrodes before assembly.

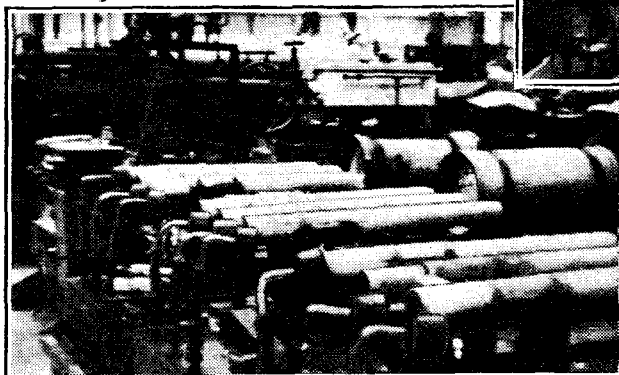

The main stream in the flow of production is the general assembly and test line. It has its source in the radio stores, which

chassis are then inverted on cradles, and the underside parts are fitted and wired until the finished chassis reaches the end of the line, where it is given a DC test to detect any obvious errors in wiring.

It is then placed on the overhead test conveyor, which runs down the centre of

continuously until all the tests have been completed. The lower tiers on the cradles are reserved for sets which present any difficulty to the routine testers, and are examined by a squad of engineers who are

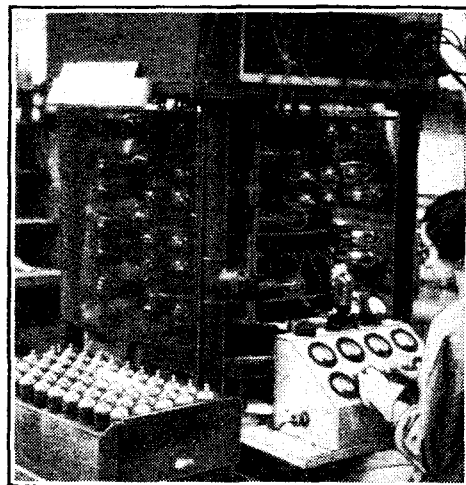

Rotary age test machine.

The Receiver Through the Factory—specialists in diagnosis. They are then returned to the appropriate point in the adjacent assembly lines for correction.

Meanwhile, sets carrying their full

are then placed on an overhead conveyor which passes through the packing department and thence to the despatching stores. Incidentally, the Service department is housed near the packing and despatch, so

the raw material to the finished set under one roof require no emphasis, and if the Ferranti works is exceptional in being so little dependent on outside sources, it does show the direction which modern set



(Left) Pupils at work in the Soldering School.

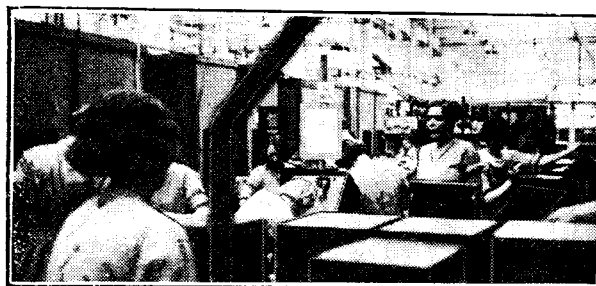

(Right) General view of audition test and final inspection department.

quota of test discs are removed from the overhead conveyor, and after a final sensitivity test are placed on a lower belt conveyor and taken down to meet the cabinets which have already been fitted with their loud speakers.

For the convenience of fitting underneath screws, and to minimise handling of the cabinet, a number of pneumatic hoists have been installed here, and, in view of the large output of sets, the amount of space occupied by this department is surprisingly small.

The set by now is looking less like a piece of scientific apparatus for handling frequencies and whatnot, and more like the handsome instrument for discoursing sweet music that it was intended to be. But before it receives its final test under broadcast conditions it must undergo a four-hour heat test during which any hidden troubles which are likely to develop will show themselves.

The final audition tests are carried out by men with a quick ear and a comprehensive technical knowledge of the set as a

that sets returned for repair do not interfere with the main flow of production.

So far we have confined ourselves to the actual making of sets, but there are many

manufacture is taking. In conclusion, we would like to thank Messrs. Ferranti, Ltd., for their willing co-operation in arranging facilities for the preparation of this article.

NOISE

THE campaign against noise has been carried on vigorously in recent years, and although it cannot yet be said that the level of noise in cities is on the wane, there is at least a strong public determination that quieter conditions shall eventually prevail.

It is to the Bell Telephone Laboratories that we owe two useful weapons in this campaign: the audiometer for the measurement of noise and the decibel for its expression in a simple way. The first results of this new method of attack appeared in a dramatic book, "City Noise," published in 1930 by the New York Noise Commission. Here was revealed the appalling noise levels reached in city thoroughfares, and the subject became one of first-class news value throughout the world. In Paris and Rome action against motor horn blowing was taken by the prefectures of police, and London followed suit in this year.

Dr. McLachlan's book* gives an extensive account of noise in general in language which is not overloaded with technical terms. We are told how noise originates, how it is measured, and how it can be reduced in intensity. Noises are classified according to where they occur, e.g., in buildings, in trains, in aeroplanes, so that a designer of any machine can look up the appropriate chapter and learn how noisy running can be avoided, and full technical details can be obtained by use of the extensive list of references to modern papers given at the end of the book.

The chapter on the physiological and psychological effects of noise is of great interest. We learn that nature has no interest in the suppression of noise since we are always immune to noises which we ourselves produce. Also, in the majority of cases noise has little immediate effect on the efficiency of workers, but more careful investigation shows that more energy is consumed by the worker in maintaining his efficiency. He resembles a constant speed motor which maintains its speed under increased load, but absorbs greater electrical power in doing so. It is also remarkable that the reaction of fear evoked by sudden sounds is one of the few reactions shown by young babies, and so appears to be an inheritance from remote stages of man's evolutionary progress. R. T. B.

*NOISE. A COMPREHENSIVE SURVEY FROM EVERY POINT OF VIEW. By N. W. McLachlan. Pp. 148. Oxford University Press. 1935. Price 6/-.



(Above) Assembling chassis and cabinets. Note the pneumatic hoists. (Left) General view of the test conveyor and benches.

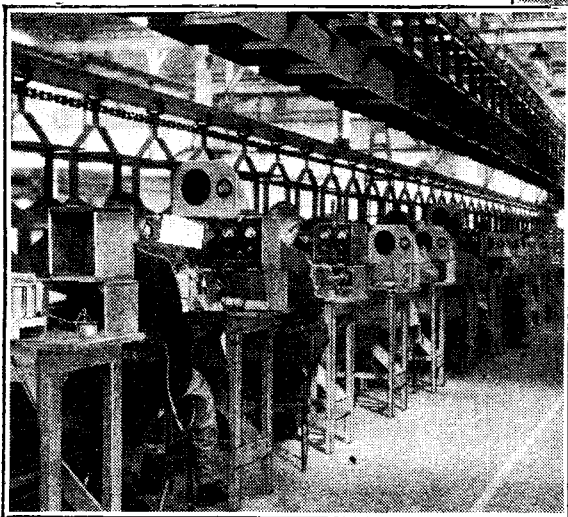

other activities which are essential to the organisation and which have not been shown in the simplified plan. There is a large central research laboratory and many subsidiary development departments distributed throughout the works in contact with the processes to which they are allied. The drawing offices, general offices and costing and filing departments cover a considerable area, as do the works and staff canteens. The power-house, which contains the compressors for operating the ubiquitous pneumatic machinery, is also a vital point in the organism.

The advantages of being able to control the whole process of manufacture from

whole. Each is ensconced in a sound-proof booth, which is fitted with an artificial aerial and a source of HF modulated by gramophone records on an automatic record-changer.

Sets which have passed the final audition test are then examined for cabinet blemishes, general appearance, and to see that knobs, etc., are fitting properly. They

Letters to the Editor

The Editor does not hold himself responsible for the opinions of his correspondents

Multi-range Testing Sets

WE have been much interested by Mr. Ernest Martin's description in your issue of July 19th of a multi-range testing set, in which he uses one of our "Dwarf" milliammeters. There are one or two points upon which we should like to comment.

Whilst it undoubtedly simplifies the design to omit the AC current ranges as Mr. Martin has done, our experience is that such ranges are distinctly useful, and we have accordingly covered such up to 1,000 mA in the new set which we have just put upon the market. In this connection we may say that Mr. Martin is in error in thinking that a rectifier-operated instrument will be damaged "if DC is applied to the AC portion." We have had rectifiers working for years with DC applied to what would normally be the AC terminals without experiencing any trouble whatever.

Mr. Martin's method of minimising the effect of a change in rectifier resistance by the use of a series condenser is ingenious, but carries with it the unfortunate disadvantage that the readings are affected by frequency and, worse still, by changes of waveform, for which latter reason we should not be inclined to place reliance upon indications when used to measure output in the way suggested.

For these various reasons we came to the conclusion in designing the testing set already alluded to that by far the best arrangement was to adopt distinct milliampere and volt scales, the same scale being used in each case for both AC and DC readings. In order to make the instrument convenient to read and to obviate the superposing of a number of figures and divisions on a single scale (in this respect we venture to think that Mr. Martin's instrument is somewhat difficult to read), we have adopted the following simple expedient:

The meter is provided with a double-ended pointer, the one moving over a scale of volts and milliamperes and the other over a scale graduated direct in ohms and micro-farads.

The simplicity of this arrangement will be at once appreciated.

EVERETT, EDGCUMBE & CO., LTD.

London, N.W.9.

[Mr. Martin in his design was naturally limited in his choice of instruments to those which were standard.—ED.]

PA Equipment in Theatres

SINCE November last I have accompanied Les Allen as his sound technician on a tour of London and provincial music-halls, and thus feel sufficiently qualified to make the following observations:—

There is no excuse whatever for either bad or indifferent public address equipments these days, and, while there may be a few of the latter, I have not yet come across one of the former. The equipments, as such, are at the worst usable, but the installation is definitely bad nine times out of ten.

Where this work is carried out by the engineers of the company supplying the equipment, they are rarely permitted to do the job properly. It is useless for them to select the correct positions for loud speakers, for instance, because either the theatre manager or that wonderful institution, "head office," have their own ideas

on the subject, and installation engineers do not seem to realise that these people know far more about acoustics, amplifiers, and the phasing of speakers than the manufacturers' own research workers! Anyway, it would seem so, because a very worried-looking sound merchant once said to me, "If Mr. B. says the speakers must go in the roof, that's where they will go!" In that particular instance, the roof would have been the worst possible place.

The nett result is that, rather than lose a sale, the manufacturer puts his gear in anyhow, and lets it go at that. Or, in the case of one large theatre circuit, an associated sound equipment company sends its engineers out on installation under the same dictatorial conditions. So much for installation.

Operation, and not infrequently maintenance as well, is usually left to the stage electrician or one of his assistants. Now, the stage electrician is a very busy man and a specialist at his job. He does not, as a rule, know anything about sound, and does not want to start learning now. It is manifestly unfair to saddle him with additional responsibilities.

Theatre proprietors and managers would do well to realise that no two halls have the same acoustic characteristics, and that the installation, operation, and maintenance of sound equipment is a specialist's work.

BRIAN DENNY.

Streatham, S.W.16.

The Broadcaster's Responsibility

I CONGRATULATE you on your editorial in the August 2nd issue of the *Wireless World*. I believe there is a movement on foot to allow advertising in the new B.B.C. charter. This movement needs fighting by every possible means, and I am more than glad to know that the *Wireless World* is on the right

side. No one who has given the matter any thought and who has the interests of broadcasting at heart, rather than his own, could possibly advocate advertising from our English stations. I do not understand why the advertising interests should imagine that they have any particular and peculiar right to use what is and should remain a national service for their own gain and profit. The only possible argument in favour of advertising is that some film star, whose fee the B.B.C. is unable to afford, will be enabled to come to the microphone to tell us what face cream she uses. No, I think most people will be willing to forgo the film star to keep our broadcasting clean.

As regards the present programmes, no reasonable person has any real cause of complaint. My only fear is that the B.B.C. is allowing itself to be more and more swayed by the self-styled mouthpieces of popular opinion in the less responsible Press, instead of continuing courageously to act up to the excellent dictum that "people should be given what they ought to like, and not what they think they do like." This remark is one of the wisest and truest that has ever been made, but merely the saying of it was, to say the least of it, somewhat misguided. "This thou shouldst have done and not have spoke on't." Shakespeare, as usual, has hit the nail well and truly on the head.

There is one other point I should like to make. It is constantly being said that it is the duty of the B.B.C. to conform to the wishes of the majority. This is, to my mind, a complete fallacy. We are so accustomed to majority government, which works well enough when there is an alternative, that people fail to see that it is entirely unsuitable and cannot work in a case such as broadcasting where there cannot be any alternative. It is the individual who pays the licence fee; it is the individual who should call the tune, and a minority of one has no less or more rights than a majority, however large. I cannot see how this in theory can be refuted, though, I admit, it could not be acted upon so completely in practice. But it does, however, point to the fact that the control of broadcasting in this country should

remain an autocracy, for it is only thus that the balance can be held even between majority and minority interests, with due weight given to intellectual, aesthetic and artistic standards.

A. H. BRIDGES.

Brighton.

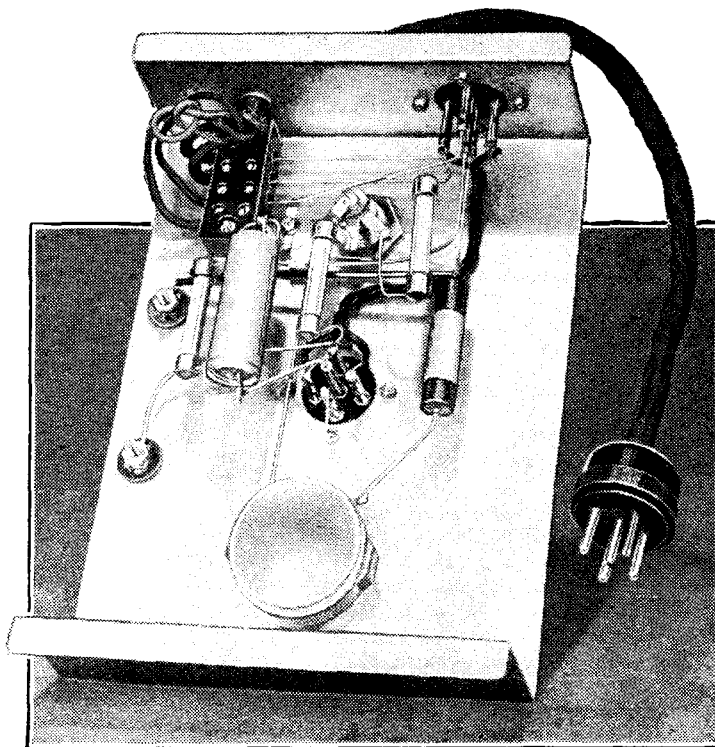

NEW FEEDER UNIT

An underbase view of the feeder-unit for the "Wireless World" Push-Pull Quality Amplifier showing the positions of the chief components. The small resistances and condensers are supported in the wiring. Constructional details of the unit appear on an earlier page in this issue.

UNBIASED

To What Base Uses

THERE is, I suppose, nothing in this world, no matter how lofty in conception, which cannot be prostituted to base ends. The use of micro-waves for the guidance of ships in fog is no exception; they have been perverted to the guidance of a vessel of another kind, namely, a vessel containing alcohol, through the self-created mental fog which invariably surrounds it.

As even women and the other less intelligent of my readers will know, it is now possible to project a micro-wave beam across a stretch of water and for ships to follow this beam accurately through fog. A suitable instrument on board gives a visual indication when the ship deviates from the beam to the left or to the right, or to port or starboard, as I suppose my nautical friends would have me say.

As I have already indicated, fogs can be mental as well as physical, but it would appear that this is no deterrent to the working of a micro-wave beam, which is equally at home with one or the other. An acquaintance of mine who, among other accomplishments, is an eminent zoologist, has for many years been troubled by the difficulty of finding his way home safely after the many dinners which his position calls upon him to attend. He lives, as a matter of fact, on one edge of

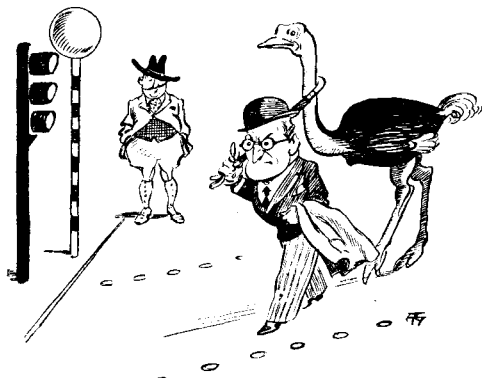

Lent me an ostrich.

Clapham Common, a lonely stretch of grass and gorse bushes, to say nothing of ponds which are fraught with very great danger to the navigator homeward plodding his bacchanalian way in the small hours of the morning.

It was to the successful navigation of this lonely stretch of moorland that my zoological friend recently bent his misplaced genius, or, perhaps I should say, induced me in all innocence to do it for him. He invited me to conduct experiments whereby living creatures could be guided over the common by means of a micro-wave beam which he had read about in the pages of this journal.

For the purpose of my experiments he lent me an ostrich from his private men-

By FREE GRID

agerie. As readers of the "Swiss Family Robinson" will know, an ostrich is easily steered by covering up the eye opposite to the direction in which it is desired that the bird should proceed. Probably those of my readers who have visited the Sydney Zoo may have seen there the living roundabout, consisting of a number of ostriches with one eye bandaged. Children are invited to ride on these birds instead of the customary elephant, and, owing to the peculiarity I have mentioned, the birds go round and round in circles entirely unattended. But I digress.

As I was saying when Mrs. Free Grid interrupted me, I was given the bird for my experimental work, and it was quite an easy matter to fix a micro-wave receiver to its back and arrange that either its right or its left eye be closed by a shutter whenever it deviated from a micro-wave beam emanating from a transmitter which I installed in my friend's house.

I little thought when I triumphantly demonstrated to my friend the success of my experimental work that he was only using me as a tool for his own base purposes. As it is he has transferred my apparatus from the ostrich's back to his own, and makes use of it to guide him across the lonely common when returning from his bacchanalian revels. I am not the sort of person to lie down under an insult of this nature, however, and I am already considering the question of installing a more powerful beam transmitter on a motor boat in the middle of one of the ponds. We shall see what we shall see.

Potted Conductor

THE B.B.C. mandarins are notorious for many things, not the least of which is their niggardliness towards those that labour for them, as I once found to my cost when I submitted a play for the consideration of their programme department. Their latest effort in this direction at least commands my admiration for the Machiavellian ingenuity with which they are setting about their task.

As many of my readers know, a certain well-known conductor (band, not bus) is about to retire. The B.B.C. are contemplating the making of a film of his conducting certain well-known musical works. They will thenceforth, long after he has

retired and been gathered to his fathers, be able to utilise his services by the simple expedient of erecting a large cinema screen behind the audience in the Queen's Hall so that the orchestra will have a view



Late of the B.B.C.

of him conducting the particular work which they are playing.

In this manner, of course, they would save the expense of the fees of famous conductors on future occasions, but this is only a small part of the sorry affair. The thing could be extended farther, and, under the guise of making publicity films, I learn that they are plotting to secure action pictures of their various other musical conductors so that in due time they may relegate them, too, to the scrap-heap.

As a beginning, I hear it is proposed that the first transmission from the television station at the Alexandra Palace shall consist of Dr. Boulton and his boys in one of their popular numbers. Dr. Boulton is to be in front of the scanning apparatus at the Palace, but the boys are to be in Broadcasting House facing a large television screen on which will be flashed the familiar features of their leader. We in our homes will, of course, see only the learned band leader, and it is thought that this little stunt of remote-control of the B.B.C. band will be a pleasant and intriguing method of launching the television service. There may be more than this behind the whole affair, however, as possibly it is merely the B.B.C.'s playful little way of commencing a service of interesting stunts which are in reality the preliminary to the taking of cinematic records of all the conductors for the purpose that I have mentioned.

Spotting the Error

I WONDER if many of you have noticed the intriguing little competition that certain radio dealers are at present engaged in staging. It consists of sticking a receiver in the window with an invitation to the long-suffering public to see how many errors they can spot in its wiring.

In the case of the shop which is nearest to me, a well-known commercial battery set is the one featured. I have spent many weary hours endeavouring to puzzle out the problem, but so far as I can see the wiring is absolutely correct, and yet I cannot very well see how that can be, as the notice concerning the competition states quite definitely that the receiver is one taken at random from stock and has not had its wiring doctored in any way.

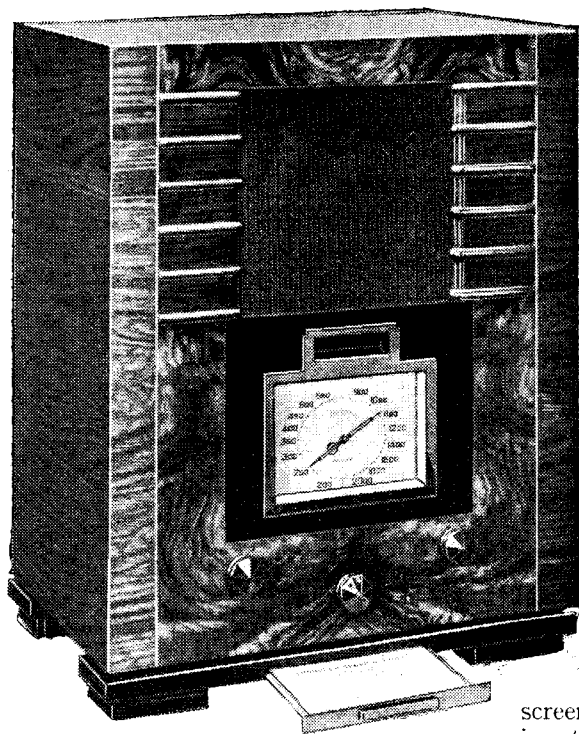

FIRST impressions would lead one to suppose that this receiver is in the 16- or 17-guinea class. The cabinet, which measures 20in. high, 15½in. wide and 10¼in. deep, is of imposing appearance and seems to demand a full round volume of tone. Expectations in this direction are fully realised, and it is a tribute to the designers and to the valve makers that such a large-scale performance has been achieved with a circuit incorporating only three valves.

The economy in valves has been brought about by the employment in the last stage of a double-diode-pentode combining the functions of second detector, AVC and output valve. The preceding stage is devoted solely to IF amplification and the first valve in the circuit is, of course, the frequency-changer.

From the aerial the signal passes through a directly coupled band-pass filter, with

screening turns between the coils, to the input grid of the frequency-changer. This valve is of the triode-pentode type and the coupling transformer between the frequency-changer and the IF amplifier is iron-cored and is adjusted to a frequency of 456 kc/s. As is usual a variable-mu pentode is employed in the IF stage, and the voltage drop in its anode feed resistance is used to operate the neon tuning indicator.

The output transformer from the IF amplifier is of the air-cored type, and its secondary feeds the signal rectifying diode of the multiple valve in the final stage of the circuit. The LF component developed across the diode load resistance is transferred to the grid of the pentode portion of this valve through a volume-control potentiometer. A switch transfers this input circuit to the pick-up terminals, and it is interesting to note that a step-up transformer has been incorporated in the set to ensure an adequate input to the final

stage from gramophone pick-ups of all types. This is a refinement which one would hardly expect to find in a set of such reasonable price.

The AVC diode takes its input from the anode of the IF valve, and the DC voltage is developed across a potential divider in order that a higher degree of control may be applied to the frequency-changer than to the IF amplifier.

Fixed tone correction is applied at the output from the pentode section of the final valve, and additional reduction of high-note response is available when a small switch at the back of the chassis is depressed. This connects an additional fixed condenser across the primary of the output transformer. Sockets are provided for the addition of an external speaker and the internal unit may be disconnected by removing a single plug on the same terminal strip at the back of the chassis.

An indirectly heated full-wave rectifier supplies the HT current, and the primary

Ultra Model 25

An Example of Modern Three-valve Superheterodyne Design

FEATURES.—*Type.*—Table-model superheterodyne for AC mains.—*Circuit.*—Triode-pentode frequency changer—var-mu pentode IF amplifier—double-diode-pentode combined second detector and output valve. Full-wave valve rectifier. **Controls.**—(1) Tuning. (2) Volume and on-off switch. (3) Waverange. (4) Tone-control switch at back. **Price.**—12 guineas. **Makers.**—Ultra Electric, Ltd., Western Avenue, Acton, London, W.3

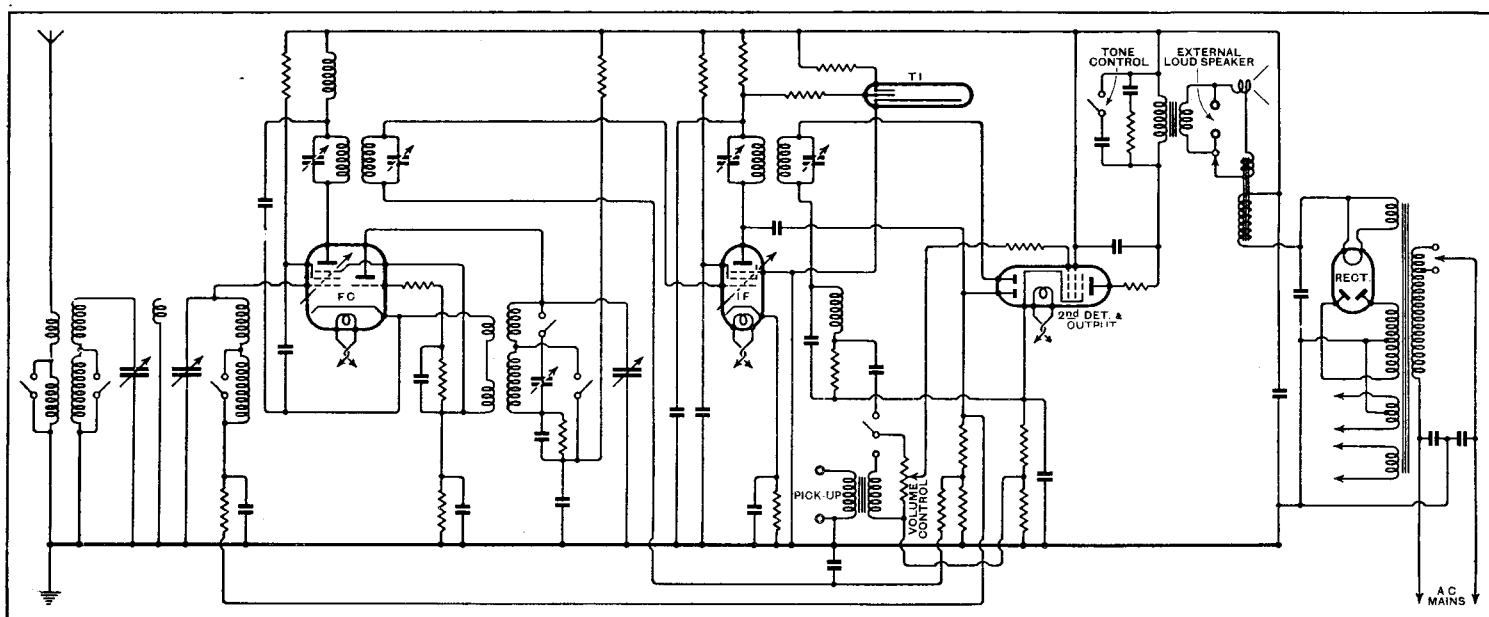

The three-valve circuit includes a combined detector-output valve, and an unusual refinement is the provision of a step-up input transformer for the pick-up.

Ultra Model 25—

of the mains transformer is shunted by a centre-tapped condenser.

The quality of reproduction is notable not only for the excellent bass response and general fullness of tone, but for the clearness with which individual instruments of the orchestra stand out from one another. This is probably accounted for by freedom from the harmonic distortion

many sets of equal intrinsic sensitivity.

Applying our usual test of noting the spreading of the Brookmans Park transmitters when operating the set in Central London, it was found that the selectivity on the medium waveband was sufficient to give reception completely clear of interference outside a fringe of two 9 kc/s channels wide on either side of the channel allocated to each station.

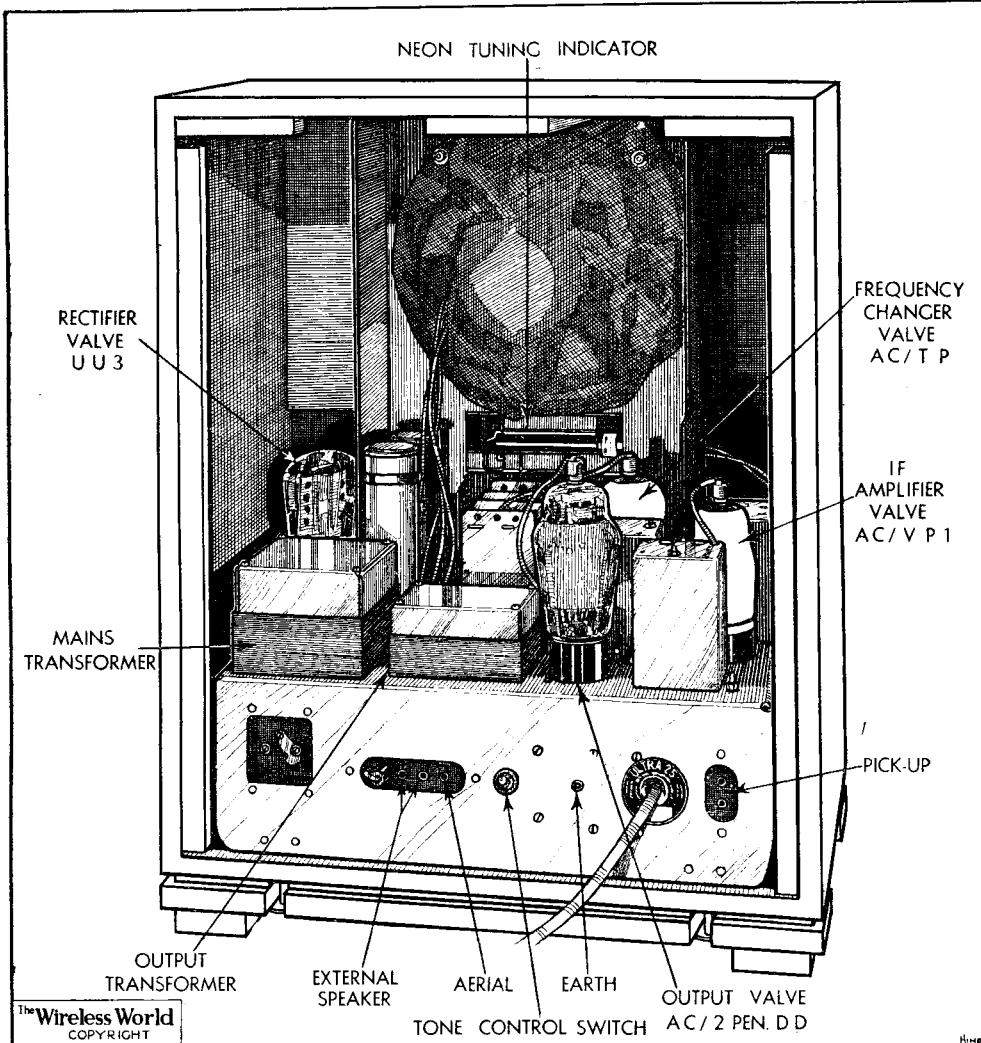

The loud speaker unit in the Ultra 25 is incorporated in the metal chassis framework.

which is often responsible for blurring of tone in receivers which may otherwise have quite a good frequency response. This supposition is supported by the unusually good quality of pianoforte transmissions, which are generally the first to suffer when serious harmonic distortion is present. It is easily possible with this set to distinguish, without hearing any announcement, whether the programme is from the studio or from gramophone records. In view of the excellent quality of modern gramophone records this can be taken as a certain indication of adequate high-frequency response.

The tone-control switch produces only a slight diminution in high-note response, but the need for further reduction is at no time apparent, as the small amount of background noise and mains interference is one of the outstanding features of the performance. For this reason the number of stations of good programme value appears to be much higher than that of

As a test of long-wave selectivity the reception of the Deutschlandsender between Droitwich and Radio-Paris is a useful criterion. Although in this case speech could be easily followed by those with the necessary knowledge of German, the reception of music was just spoilt by the residual side-band interference from the adjacent stations. This, of course, is a severe test of selectivity, and most people would agree that the unusually high volume from Radio-Paris, Huizen, and other long-wave stations, and general absence of background noise would more than compensate for the loss of the German station.

Efficient AVC

The automatic volume control works well, and there is little difference in the volume from the Midland, West and North Regional stations when received in Central London. Although the volume

Next Set Review—
MULLARD MU35

from London Regional is relatively slightly higher, the difference between this station and those previously mentioned is not sufficient to justify any readjustment of the manual volume control.

In view of the high intermediate frequency we were rather surprised to find a self-generated whistle on the medium waveband. This occurred just above 350 metres, but was well clear of the London Regional station.

The chassis and loud speaker form a single unit which is easily removed from the cabinet for testing and servicing. A rather unusual type of ganged tuning condenser has been adopted. The oscillator section is in the middle, and has specially shaped vanes, so that padding condensers are used only on the long waveband.

The tuning dial is of the clock-face type and is calibrated in wavelengths but carries no indication of station settings. These are supplied on a chart fitted in a sliding drawer in the base of the cabinet. Above the tuning dial is a horizontal neon tuning indicator which is of an unusually sensitive type. When the discharge reaches the end of the long electrode, as it does quite easily when tuning in a powerful transmission, the range of indication is not exhausted as there is a change in the shape of the tip and an increase in the general luminosity. Thus it is quite easy to go straight to the point of exact tune on a powerful station without having to estimate the mid-point between two positions on either side, as sometimes happens with tuning indicators of this type.

COMMERCIAL ENQUIRIES

THE WIRELESS WORLD regularly receives enquiries both from home and abroad for the addresses of sources of supply for various items of wireless equipment. It has been our custom to assist enquirers as far as possible by letter. The increasing number of such requests prompts us to commence the publication of such enquiries in order that an equal opportunity may be given to all trade readers of *The Wireless World* to forward particulars when they are in a position to meet these demands.

Below we give a list of some requests contained in recent letters. Replies, addressed *c/o The Wireless World*, and bearing the reference number appearing in front of the requests, will be forwarded. Envelopes must be stamped with the proper postage for home or abroad, as indicated.

C.E.1.—Coil screens for *The Wireless World* Olympic S.S. Six. (Home.)

C.E.2.—Field intensity meters. (Abroad.)

C.E.3.—H.T. converters for car radio. (Abroad.)

C.E.4.—Vibrators for car radio. (Abroad.)

C.E.5.—Insulating material for iron powder cores which will harden after heat treatment process. (Abroad.)

C.E.6.—Components for television transmitters for 180 lines. (Abroad.)

C.E.7.—Headphones and compensating resistances for hospital equipment. (Abroad: Home agent.)



The

PERMANENT MAGNET

Sheffield's Decade of Research and Progress

Industry

IV.—THE PERMANENT MAGNET'S SPECIAL ADVANTAGES

IN the early days the permanent magnets for moving-coil loud speakers were insensitive, heavy, and expensive. (By insensitive is implied low in flux density.) With three handicaps such as these, why was the permanent magnet used at all? Simply because these drawbacks were smaller in degree than the difficulties associated with providing energised field-magnets together with a source of excitation, especially in the case of extension speakers and installations operated from batteries. Furthermore, in the case of mains-operated sets the increase in the size of the power unit would be economically prohibitive, so that the fundamental demand for the permanent magnet can be classified under the following headings:—

- (a) Built-in loud speakers for battery-operated receivers.
- (b) Extension loud speakers for battery-operated receivers.
- (c) Extension loud speakers for mains-operated receivers.
- (d) Built-in loud speakers for mains-operated receivers.
- (e) Loud speakers for radio-relay installations.
- (f) Loud speakers for public address purposes.

All applications are well established with the exception of possibly (d), which class is the stronghold of the energised electro-magnet. However, one very large and important firm in quest of quality uses

THE permanent-magnet moving-coil loud speaker has now reached the point where it can challenge the energised type not only on grounds of efficiency but also of cost. This article gives the many reasons for supposing that in the very near future we may see the permanent-magnet speaker generally adopted in mains-operated as well as in battery sets.

permanent magnets exclusively, even in mains-operated sets, and the quantities involved run into hundreds of thousands per year. Apart from this case there is an interesting and maybe important present trend in design relative to the use of the permanent magnet in mains sets.

Nature of Alloys

Until the advent of nickel-aluminium alloys, the most attractive material available for designing moving-coil permanent magnets was 35 per cent. cobalt steel, but this was expensive, and steels containing lower percentages of cobalt were thus more commonly used. The magnets were therefore heavier the lower the cobalt content, but still relatively expensive on account of the cost of cobalt itself, and the necessity for a rather complicated triple heat-treatment process. The economic situation was largely met by the greater

use of cast chrome steel magnets, but these suffered from their somewhat extreme heaviness, general bulk, and the necessity for a long magnetic path-length. Thus, whichever alternative was taken, it was certain to be criticised on the score of either insensitiveness, weight or cost.

To-day the situation is changed. With nickel-aluminium alloys, practically any gap flux performance can be achieved without excessive weight or cost. Thus, smallness of size, general neatness in appearance of the eye, and previously unheard-of cheapness in cost for equivalent performance are now the outstanding features of the permanent magnets available to the radio industry at the present time. Gone are the days when having fitted a magnet to the chassis of an energised speaker it was necessary to stiffen the front of the set or cabinet on account of the excessive applied bending moment. Furthermore, as compactness in layout has become a regular feature in modern sets, the fact that it is now possible to make a permanent magnet more compact than the energised magnet which it replaces represents a real advance, and is a point to which any progressive designer hard-pressed for space would do well to give attention. In magnetic constancy, too, the new alloys are much superior to the chrome alloys which they are superseding, and are largely unaffected by vibration, temperature, and stray demagnetising influences such as would be

The Permanent Magnet Industry—

commercially serious a year or so ago. In fact, they do actually possess a considerable number of the individual attributes of the ideal "permanent" magnet material.

In the past there has been a measure of wastefulness in the radio industry, due to the maintenance of large numbers of different types of moving-coil speakers. It is now feasible to produce economically and in large quantities a permanent-magnet speaker of adequate sensitivity, suitable for use in either mains- or battery-operated receivers. This procedure would greatly simplify production and subsequent servicing, and now that some measure of stability is being achieved there is less reason and justification for the small but costly annual modifications in design, especially as the speaker is now taken more for granted than ever before.

When this matter is discussed it is common to hear the time-honoured argument advanced that in all cases the energised pot-magnet is less costly to produce than the permanent magnet. Until recently the contention was sufficiently true to limit permanent magnets to those cases where they were a necessity, as distinct from where they were desirable. The new alloys have challenged the position, and the above contention can now be effectively contested with a certain chance of complete success in several directions. Perhaps it would be as well to point out at this stage some of the other considerations which should be borne in mind.

Important Considerations

For reasons of economy the field-winding of the ordinary mains-energised moving-coil loud speaker is arranged to exercise a dual function. First, it carries the main rectified current for the whole set, and this current, multiplied by the number of turns in the field coil, gives the average magnetising ampere-turns available in the magnet for setting up and maintaining the working gap flux density for the voice-coil. Secondly, on account of the imperfect rectification of the alternating supply, the field-winding is used as a smoothing choke for the whole set, and this implies that besides carrying a unidirectional magnetising current it also carries a small alternating current, which with biphasic rectification is of twice the frequency of supply. Thus in the case of the usual alternating 50 cycle per second main supply, there is a small 100 cycle per second alternating current traversing the field-winding. This impresses a cyclic variation on the steady driving flux of the magnet, and, unless carefully compensated for, is a potent source of hum and of aural distortion known as "modulation distortion." Thus it is not difficult to appreciate that the best results are obtained when an absolutely constant magnetic field, such as is derived from a permanent magnet, is used for driving the voice-coil of the loud speaker, and the rectified direct current input to the set is smoothed by

the use of an independent choke. This method is rapidly gaining favour, especially when the demands for quality are made more stringent. There is greater freedom from hum and background noise. The risk of the magnet field-coil burning out is removed, and the chance of this happening is certainly greater than with an ordinary separate choke. Perhaps an even more annoying source of trouble with energised magnets—especially the less expensive ones—is when the layers of the windings become short-circuited due to defective insulation, and faults of this kind seriously lower the inductance of the winding and hence disturb the initial fixed electrical adjustments, with consequent increase in hum and decrease in general sensitivity, thereby making the defect appear doubly worse.

Another advantage in the use of a permanent magnet is that it runs "cold." With certain energised electro-magnets the attempt to set up high flux densities with a not too generous allowance of copper in the field results in high temperatures being attained, and heat from the top plate and from the centre pole causes expansion of

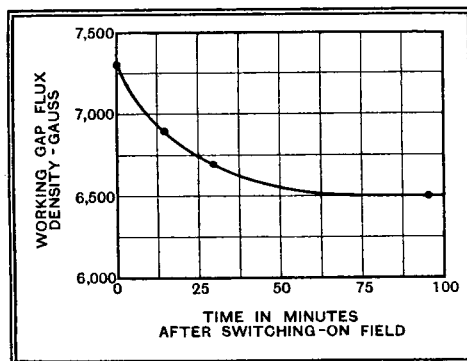

Fig. 1.—Showing time-flux relationship for energised magnet.

the voice-coil which, if adjusted critically with respect to its clearances, will eventually "rub" after a period of steady running, with distressing results to the ear. A permanent-magnet speaker can, therefore, under comparable conditions, be rated higher for voice-coil power-handling capacity than its energised counterpart, because the pole system, instead of communicating heat to, actually absorbs heat from the voice-coil, thereby making an increase in voice-coil current permissible for a given rating of temperature rise. Alternatively, the "cold" permanent-magnet field system can be regarded as enabling greater efficiency in the loud speaker to be attained, because the clearances round the moving coil in the gap can be safely reduced. This is possible because the risk of undue coil expansion is eliminated.

There is another effect not widely appreciated regarding the heating of the field-coil which is obvious after a moment's thought. In uncompensated circuits the current magnetising the magnetic circuit of the electro-magnet falls as the resistance of the field-winding rises with temperature, and thus the ampere-turns drop and hence the gap flux density decreases

after a comparatively short time. An actual set of results are shown plotted in Fig. 1 and refers to a winding dissipating 6 watts at 110 volts. The tests were carried out under ideal conditions of heat dissipation, and had the magnet been enclosed in a set or cabinet the flux densities would certainly have been even lower.

A further point is that the elimination of the use of the energised field for smoothing purposes, and its replacement by a low-resistance choke, results in additional voltage being available for operating the valves in the set. This is particularly important when the designer is not attaining quite sufficient overall sensitivity, and the factor of cost precludes the use of larger valves, transformers, and rectifiers.

Conclusion

A consideration of the above remarks will show that a more progressive use of the permanent-magnet speaker will enable substantial improvements in quality and reliability to be made without being uneconomic. The fact that a number of luxury sets are being laid out on these lines is sufficient indication of what may be expected in the near future, and its extension to more ordinary receivers is assured.

In conclusion, it is hoped that this series of articles, in describing the many factors involved in the production and use of permanent magnets for the radio industry, has shown clearly that with the advent of the new nickel-aluminium alloys a revolutionary change has taken place in Sheffield's magnet industry which, by its ready response, has placed it in the vanguard of progress.

This is the concluding article of a series on the permanent magnet industry. For earlier articles see issues dated March 29th, April 26th, and June 28th, 1935.

THE RADIO INDUSTRY

HALFORD DISTRIBUTORS, LTD., of 39, Sackville Street, London, W.1, have sent us the specification of an interesting "straight" short-wave chassis covering wave lengths between 12 and 100 metres in three steps. Six receiving valves in all are used, with an HF stage and push-pull output pentodes giving $4\frac{1}{2}$ watts. The price is 28 guineas.

Readers are invited to attend demonstrations of the Voigt loud speakers during the period of the Exhibition at 9, Maclise Road, close to Olympia. A high-class radio-gramophone and *The Wireless World* Quality Amplifier will be used.

Film Industries, Ltd., of 60, Paddington Street, London, W.1, have recently installed public address equipment in the Great Hall at Winchester House.

The British Thomson-Houston Company recently carried out the installation of sound amplifying equipment for the Leeds Elementary Schools Athletic Association Meeting at Roundhay Park.

The telephone number of Claude Lyons, Ltd., of 40, Buckingham Gate, London, S.W.1, is now Victoria 3068/9.

Exhibitors at Olympia

Alphabetical List, with Stand Numbers and References to Plan Opposite

Name.	Stand.	Name.	Stand.	Name.	Stand.
ACE Radio	97	A 2 Dubilier Condenser Co. Ltd.	67	C 5 NATIONAL Radio Service Co.	12
Adey Portable Radio	1	C 5 Dulcet-to-Polyphon, Ltd ..	T16	F 1 New London Electron Works,	
Aerialite, Ltd.	8	D 4 Dyson, J., & Co., Ltd. ..	T17	F 1 Ltd.	39
Aerodyne Radio, Ltd.	72	C 2 EAST LONDON Rubber Co.,			D 1
All Power Transformers, Ltd.	211	H 5 Ltd.	T18	E 1 OLDHAM & Son., Ltd. ..	66
Allwave International Radio				H 3 Ormond Engineering Co., Ltd.	33
& Television, Ltd.	109	A 2 Eastick, J. J., & Sons (Ealex)	T9	A 2 Orr Radio, Ltd.	96
Anson & Hopwood, Ltd.	87	B 2 Edison Swan Electric Co.,		A 3 Ossicaide, Ltd.	121
Automatic Coil Winder &		B 2 Ltd. (Ediswan)	79		
Electrical Equipment Co.				PARTRIDGE , Wilson & Co.,	
Ltd. (Avo)	103			Ltd.	104
BALCOMBE , A. J., Ltd.				B 5 Peto & Radford	94
(Alba)	65			A 1 Philips Lamps, Ltd.	62
Beethoven Radio, Ltd.	60			C 3 " Pianomaker, The "	T29
Belling & Lee, Ltd.	91			E 5 Plessey Co., Ltd.	20
Benjamin Electric, Ltd.	42			D 1 Portadyne Radio	99
Bird, Sydney S. & Sons, Ltd.				A 3 Primus Manufacturing Co.,	
(Cyldon Radio).. .. .	118			Ltd.	19
Britannia Batteries, Ltd.	40			D 1 Prism Manufacturing Co. ..	116
British Blue Spot Co., Ltd. ..	28			A 1 Pye Radio, Ltd.	84
British N. S. F. Co., Ltd. ..	48			B 4 RADIO Gramophone Develop-	
British Permel Enamelled				C 3 ment Co., Ltd. (R.G.D.)	
Wire, Ltd.	50			B 2	89
British Pix Co., Ltd.	201			H 3 B 2 & 88	B 1
British Rola Co., Ltd.	43			A 2 Radio Instruments, Ltd. (R.I.)	102
British Television Supplies,				A 4 Radio Society of Great Britain	202
Ltd. (B.T.S.)	14			H 5 R.A.P., Ltd.	106
British "Wireless for the				A 3 Rawlplug Co., Ltd.	120
Blind" Fund	52			A 3 Regentone Products, Ltd. ..	93
"Broadcaster, The"	T26			A 1 Reproducers & Amplifiers,	
Brown Bros., Ltd.	T12			Ltd. (R. and A.)	56
Brown Radio Co., Wm. F. ..	210			C 1 Rists Wires & Cables, Ltd. ..	213
Browning Wireless Manufac-				G 5 SELECTA Gramophones, Ltd.	T24
turers	228			E 3 Siemens Electric Lamps &	
Bulgin, A. F., & Co., Ltd. ..	117			Supplies, Ltd.	100
Burgoyne Wireless, Ltd.	2			A 3 Sonochorde Reproducers, Ltd.	54
Burndept, Ltd.	61			C 1 Sound Sales, Ltd.	108
Burton, C. F. & H.	105			A 2 Stratton & Co., Ltd. (Eddy-	
Bush Radio, Ltd.	85			stone)	30
CADISCH & Sons	T20			D 4 Sufflex, Ltd.	205
Celestion, Ltd.	26			H 4 Sun Electrical Co., Ltd. ..	T15
Central Equipment, Ltd. ..	3			D 3 Swift, Levick & Sons, Ltd..	113
Chloride Electrical Storage				D 2 TANNOY Products	90
Co., Ltd. (Exide and				D 1 Telegraph Condenser Co., Ltd.	
Drydex)	59			(T.C.C.)	37
Churchmans, Ltd.	T30			D 2 Telephone Mfg. Co., Ltd.,	
City Accumulator Co., Ltd.				(T.M.C.-Hydra)	29
(C.A.C.)	38			D 4 Thompson, Diamond, &	
Clarke, H., & Co. (M/c), Ltd.				Butcher	T19
(Atlas)	83			E 1 Tucker Eyelet Co. Ltd. ..	122
Climax Radio Electric, Ltd. ..	22			A 3 The 362 Radio Valve Co., Ltd.	212
Cole, E. K., Ltd. (Ekco) ..	76			H 5 ULTRA Electric, Ltd.	73
Colvern, Ltd.	55			C 2 Union Radio Co.	18
Concordia Electric Wire Co.	218			D 1 VANDERVELL , C. A. Ltd.,	214
Cosmocord, Ltd.	221			G 5 Varley	31
Cossor, A. C., Ltd.	70			D 4 Vidor, Ltd.	98
Crypto Equipment Co.	215			A 3 WATERHOUSE , Frederick,	
DALLAS , J. E. & Sons, Ltd.	T3			Ltd.	219
Darwins, Ltd.	107			E 5 Webber, J. M., & Co., Ltd. ..	T2
Davies Woodwork, D. M. ..	45			H 4 Westinghouse Brake & Signal	
Dayzite, Ltd.	T5			A 4 Co., Ltd.	101
Decca Gramophone Co.	34			A 4 Weston Electrical Instrument	
De la Rue, Thomas, & Co.,				Co., Ltd.	216
Ltd.	5			F 5 Wharfedale Wireless Works..	203
Dent, R. H. (Ardente)	46			H 4 Whiteley Electrical Radio Co.	95
Department of Overseas				A 2 Wingrove & Rogers, Ltd. ..	49
Trade	52			B 1 "Wireless & Gramophone	
Dew, A. J., & Co., Ltd. ..	T21			Trader, The"	T27
Dibben, Horace, Ltd. ..	T1			E 4 Wireless Retailers Association	T4
Diggle, A., & Co., Ltd. ..	16			H 3 "Wireless World, The" ..	6
				D 4 Wright & Weaire, Ltd.	
				(Wearite)	217
				F 5	

The Wireless World STAND FINDER

GUIDE TO ALL EXHIBITORS AT OLYMPIA

Any Stand in the Exhibition can instantly be located by using this squared plan in conjunction with the references shown in black type in the accompanying list of exhibitors

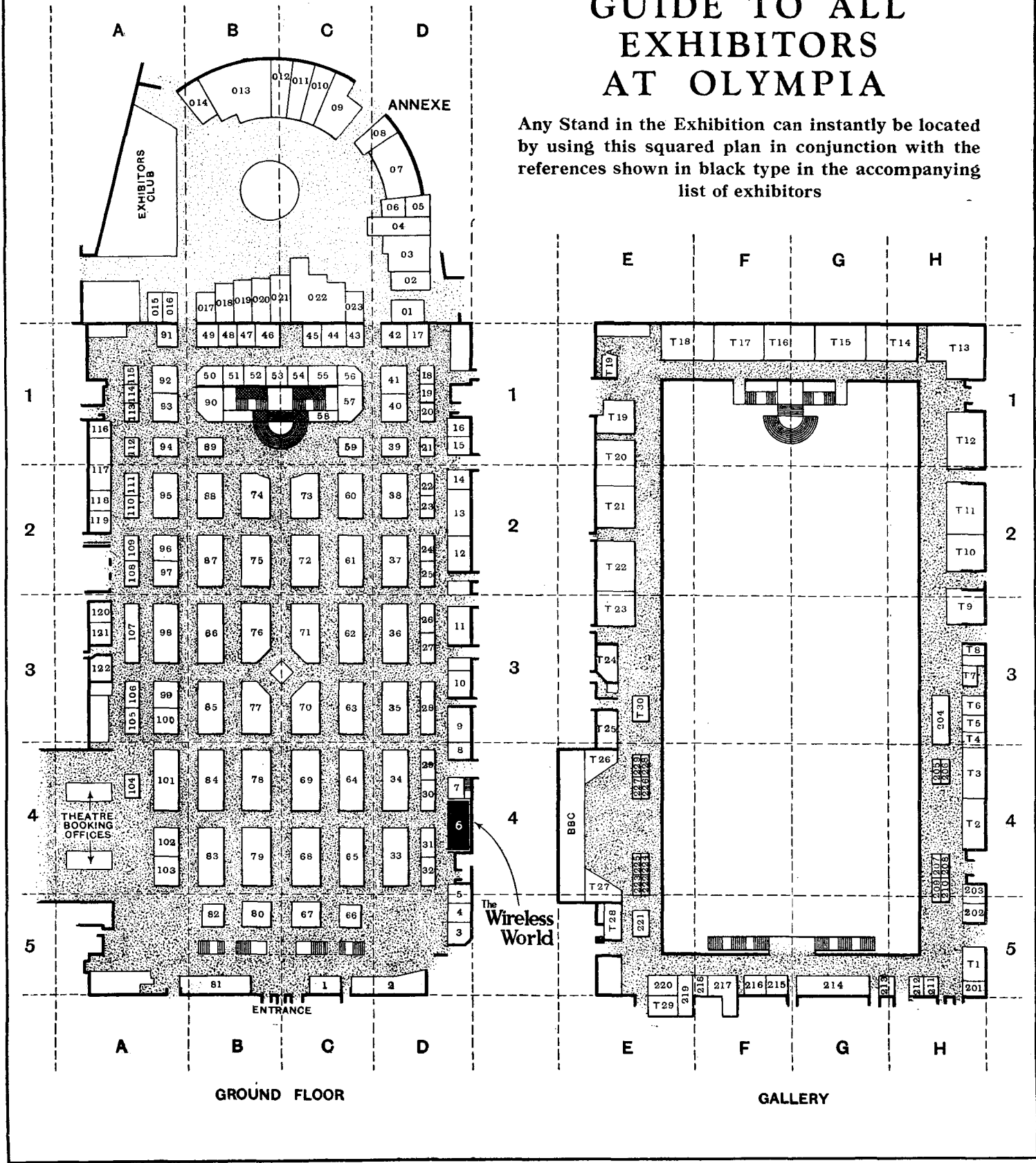

A selection of Constructional Receivers recently described in the pages of this journal will be on view at "The Wireless World" Stand (No. 6).

Readers' Problems

THESE columns are reserved for the publication of matter of general interest arising out of problems submitted by our readers. Readers requiring an individual reply to their technical questions by post are referred to "The Wireless World" Information Bureau, of which brief particulars, with the fee charged, are to be found at the foot of this page.

Better Reaction

THE serious shortcomings of reaction as an aid to sensitivity are constantly being pointed out by contributors to this journal; indeed, new sticks with which to beat the old friend which has served us so well in the past are still being found. But, in spite of all this, it cannot be denied that reaction still has its uses in certain special-purpose receivers of the simpler kind, and that the sensitivity of the humble det.-LF combination with critically controlled reaction is amazingly high.

A correspondent who has just built a set of the type we have in mind is disappointed to find that the reaction control, though good enough by ordinary standards, is susceptible to improvement. After giving some details of his set, he asks for suggestions.

The circuit design seems to be in order, and we think it probable that the deficiency of which our reader complains is simply due to the fact that the present operating conditions are not entirely suitable for the detector valve in use. It is therefore suggested

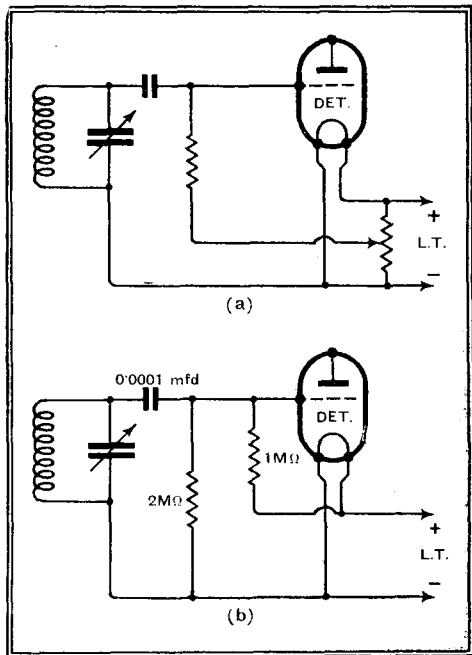

Fig. 1.—Two methods of improving the smoothness of reaction control.

that one or other of the arrangements shown in Fig. 1 should be tried. By means of the first (dia. (a)), the operating potential of the detector grid may be adjusted by means of a potentiometer having a resistance of from 200 to 400 ohms. A tapped potentiometer is almost as good as a fully variable one, and is much more compact.

The arrangement just described is well known; another scheme that has lately been introduced is that illustrated in dia. (b). Here the same effect is obtained by using two grid leaks of different values, one con-

nected to positive LT and the other to negative LT. By changing the relative values of the leaks different bias voltages can be obtained, but, in general, the values shown will be found satisfactory.

Almost Too Obvious

A CORRESPONDENT who is living temporarily in a flat in a steel-framed building finds that the sensitivity of his receiver—also of a temporary nature—is entirely inadequate even for reception of the local stations when used with the longest indoor aerial possible. Results are equally poor when the mains are used as an aerial, and no other form of collector seems to offer itself. We are asked to suggest a simple way of increasing signal pick-up without altering the receiver to improve its sensitivity.

We are almost ashamed to offer the obvious suggestion that the aerial should be thrown out of the window. But it is a fact that this procedure will almost certainly increase signal strength enormously in any metal-framed building, especially if the hanging aerial wire can be kept reasonably clear of walls, etc.

Day and Night

A USER of a high-quality short-range set has nothing but praise for the quality of reproduction during daylight, but is worried by the fact that in the evening an annoying high-pitched whistle becomes evident as a background to the local station.

This is a familiar trouble for which the blame must be apportioned to the Heaviside layer. It means that towards dusk or after dark the signal strength of some foreign station occupying the next frequency channel becomes sufficiently strong to interfere with reception.

Here is a clear case for some simple form of variable selectivity or whistle suppression. If our correspondent cares to send details of his set, we can probably suggest something.

A Sign of Decay

THE built-in tapped transformer fitted to a number of loud speakers has at least one use other than that for which it was primarily intended. If, for instance, it is found that an improvement is effected by making a radical change from the adjustment found initially to give best volume and quality, we have a fairly certain indication that the output valve has changed its characteristics. In all probability its emission has declined, and, if the improvement is clearly perceptible by ear, the falling-off is probably serious.

This seems to explain the experiences described by a reader. When his set was first built, nearly a year ago, the adjustment for best results was carefully made and was quite definite. Now, however, it has been found that a considerable alteration is necessary to get the best out of the loud speaker. We fear that a new output valve is needed.

In the Air

A TUNED circuit with both ends at high oscillating potential with respect to earth is distinctly embarrassing to any designer or constructor, especially if it happens to be a tunable circuit operating at signal frequency; in a superheterodyne an

IF circuit of this kind can usually be disposed of fairly easily.

These remarks are prompted by a request for information as to a suitable method of feeding to a push-pull amplifier directly from a diode detector which forms part of a "straight" receiver. Our querist seems to imagine that it is essential for the tuned circuit preceding the diode to be "in the air."

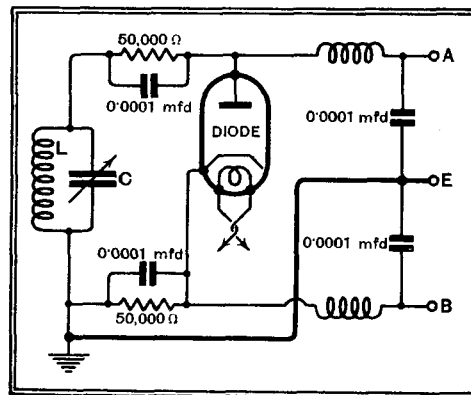

Fig. 2.—Method of feeding a push-pull amplifier from a diode detector, which allows one side of the circuit LC to be earthed.

This is not so, as by adopting the circuit shown in Fig. 2 it becomes possible to earth one side of the tuned circuit; of course, these remarks are only applicable to a set employing indirectly heated valves.

Suggested values for condensers and resistances are given in the diagram, while the output terminals for connection to the high potential input terminals of the amplifier are marked A and B.

Testing an Oscillator

THE superheterodyne is in such general use nowadays that almost everybody knows how to ascertain whether the oscillator is functioning properly. For the benefit of a querist who is having trouble with a test oscillator, it may be pointed out that exactly the same procedure is applicable to the valve of this instrument.

A milliammeter should be inserted in series with the HT feed, and it should be noted whether any change of current takes place when the anode coil is short-circuited; such a change indicates correct operation, or at any rate that the valve is oscillating.

The Wireless World

INFORMATION BUREAU

THE service is intended primarily for readers meeting with difficulties in connection with receivers described in *The Wireless World*, or those of commercial design which from time to time are reviewed in the pages of *The Wireless World*. Every endeavour will be made to deal with queries on all wireless matters, provided that they are of such a nature that they can be dealt with satisfactorily in a letter.

Communications should be by letter to *The Wireless World* Information Bureau, Dorset House, Stamford Street, London, S.E.1, and must be accompanied by a remittance of 5s. to cover the cost of the service.

Personal interviews are not given by the technical staff, nor can technical enquiries be dealt with by telephone.

The Wireless World

THE PRACTICAL RADIO JOURNAL
25th Year of Publication

No. 834.

FRIDAY, AUGUST 23RD, 1935.

VOL. XXXVII No. 8.

Proprietors: ILIFFE & SONS LTD.

Editor:
HUGH S. POCOCK.

Editorial,
Advertising and Publishing Offices:
DORSET HOUSE, STAMFORD STREET,
LONDON, S.E.1.

Telephone: Hop 3333 (50 lines).
Telegrams: "Ethiaworld, S. dist. London."

COVENTRY: Hertford Street.
Telegrams: "Autocar, Coventry." Telephone: 5210 Coventry.

BIRMINGHAM:
Guildhall Buildings, Navigation Street, 2.
Telegrams: "Autopress, Birmingham." Telephone: 2971 Midland (4 lines).

MANCHESTER: 260, Deansgate, 3.
Telegrams: "Iliffe, Manchester." Telephone: Blackfriars 4412 (4 lines).

GLASGOW: 26B, Renfield Street, C.2.
Telegrams: "Iliffe, Glasgow." Telephone: Central 4857.

PUBLISHED WEEKLY. ENTERED AS SECOND CLASS MATTER AT NEW YORK, N.Y.

Subscription Rates:
Home, £1 1s. 8d.; Canada, £1 1s. 8d.; other countries, £1 3s. 10d. per annum.

As many of the circuits and apparatus described in these pages are covered by patents, readers are advised, before making use of them, to satisfy themselves that they would not be infringing patents.

CONTENTS

	Page
Editorial Comment	209
Analysis of the New Set Designs ..	210
A Good Start for the New Set ..	217
Current Topics	219
High Fidelity in the Home ..	220
The New Season's Components and Accessories	222
Radiolympia 1935, By a Critic of Quality	226
Unbiased	227
Listeners' Guide for the Week ..	228
Sound Reproduction	230
Mullard MU35 Reviewed ..	232
Mechanical Highlights Seen at the Show	234
Broadcast Brevities	236
Applications of the New Valves ..	237
Olympia "Side Shows"	239
Letters to the Editor	240

EDITORIAL COMMENT

Manufacturers' Caution *Reasons Why Novelties are Scarce*

AT the time of writing, when the period of the Radio Show is coming to an end, it is interesting to try to sort out the mass of information and detail collected and arrive at an idea of what are the outstanding improvements of the year. In a number of articles in this issue we endeavour to give our readers our impressions as to what technical advances have been made.

Whilst these articles deal mainly with specific technical innovations, we must not lose sight of the fact that radio manufacture has, so to speak, "moved up" in all branches, in that all sets are better built and better designed. Although, as we have already noted, prices have not been reduced, yet in actual fact, we find that the equivalent of a price reduction has taken place in the case of most of the sets, for the reason that the new sets are so superior to those of last season at the same prices.

Reliability the First Concern

The construction of receivers has become much more of an engineering job. The days have gone when components "hung by their eyebrows" on different parts of the chassis. So, too, in the interests of testing and servicing, the practice has disappeared of making some parts of the chassis inaccessible because of the components fitted in the later stages of construction. It is no longer necessary to partially dismantle a receiver to test or service it. These points may seem trivial in theory, but in practice they make a world of difference. Manufacturers have found that the future success of their business depends as much on the reliability of the set after purchase

as it does on its initial performance. It must not be forgotten that the distributors to the trade who act as a go-between to the manufacturers and the public soon find out if too high a percentage of any manufacturer's sets is giving trouble and will then favour some other make instead. This necessity for reliability has another effect too in that it puts a brake on the introduction of novelties which might give trouble later on. In fact the manufacturer to-day, producing as he does to a definite programme in very large quantities, will take no risks with devices which may be regarded as in an experimental stage, although in special sets he may incorporate these and manufacture in smaller quantities at higher prices where he is prepared for some servicing until they have proved their reliability.

In the Public Interest

We must not be too ready therefore to think that the absence of many circuit and other novelties in the sets of this year means that manufacturers are not alive to their potential value—it may be and probably is the case, that they attach more importance to reliability than to novelty, and the purchaser will gain in the long run by such a policy provided it is not overdone.

The foregoing remarks in regard to receivers apply to almost the same extent in the case of valves and components. Although these are being manufactured in ever-increasing quantities, their reliability is greater. The demands of set manufacturers have to be met, and since reliability has become the first consideration of the manufacture of complete sets, the component parts must be equally reliable. The saying that a chain is as strong as its weakest link applies particularly well to wireless sets, every component of which forms an essential link in the chain.

Analysis of the

What the Exhibition Reveals

DEVELOPMENT in broadcast receivers is a continuous process which is still going on in spite of the vast strides made in recent years, and which is likely to continue for years to come. Some sort of standardisation has been reached in the basic circuits, but the refinements and modifications introduced by different firms vary so greatly that it would be a mistake to think that their products are even similar. Several distinct trends of development are evident in the products shown at Olympia, but they overlap so much that the casual observer is apt to underestimate their importance and to attribute them merely to the minor differences just referred to. There are four main trends this year—variable selectivity, all-wave

always to obtain the highest standard of reproduction consistent with the interference to which a station is subject.

Variable Selectivity

The methods adopted for obtaining variable selectivity are many and varied and are all of great technical interest. Although there may be a trend towards the employment of variable selectivity, there is as yet no uniformity in the methods of obtaining it. There is perhaps a slight preponderance in favour of varying the coupling between the coils of the IF transformers, and this system is adopted in the R.G.D. Model 1203 receiver. Two IF stages are used with high efficiency air-core Litz-wound coils trimmed by air-dielectric condensers in the IF transformers. The coupling between the coils in one transformer is fixed, and that between the coils in the other two is variable by means of a panel control. Although the coupling is actually variable by sliding the coils relative to one another, stops on the control make the action rather than that of a selectivity switch giving four definite degrees of selectivity. In the H.M.V. High-Fidelity apparatus, however, true switching is employed, and the coupling of the signal-frequency circuits is altered as well as that of the IF transformers, while the response of the low-frequency amplifier is also varied.

The Dynatron receivers are straight sets, and, as might be expected, the arrangements for variable selectivity are more complicated. Switching is employed which not only alters the value of the coupling inductances in the band-pass filters, but also varies the HF resistance

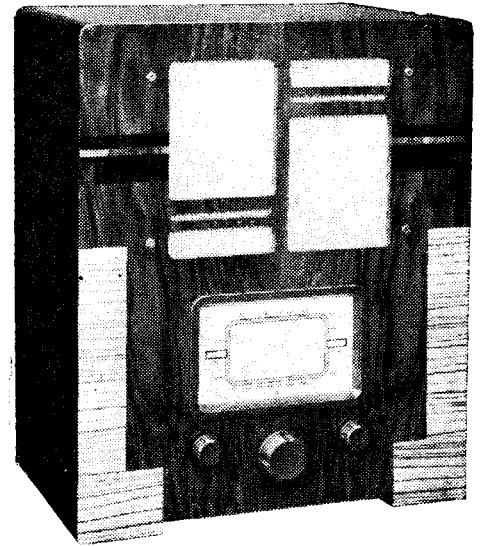

The Kolster-Brandes Model KB426 receiver.

the selectivity remains constant throughout the waveband. The coupling coils are fitted with movable iron cores which are linked together and to the main tuning control, so that the coupling varies with the tuning in such a way as to maintain constant band-width.

The Kolster-Brandes superheterodynes have variably-coupled IF transformers in which one coil is moved axially relative to the other. A considerable variation is allowed, and when maximum selectivity has been reached a further movement of the control knob operates a switch which throws a by-pass condenser in circuit to restrict still further the high-frequency response. A different system is adopted in the Allwave International receiver, however, and it is not mechanical but electrical. The two tuned circuits com-

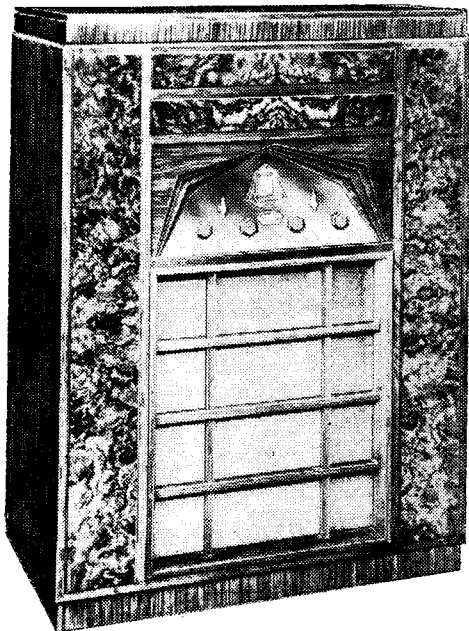

The R.G.D. Model 1203 radio-gramophone.

reception, QAVC, and the three-valve superheterodyne.

In the benefit which it confers on the user the first of these is undoubtedly the most important, and it is safe to say that no single development has ever done more towards the improvement of quality of reproduction. Very high selectivity is a necessity for the interference-free reception of distant transmissions, and the higher musical frequencies are then inevitably attenuated. This loss of treble is unnecessary in local reception, for there is then no call for high selectivity. In the past, therefore, with a fixed degree of selectivity designers have been forced to adopt a compromise between selectivity and quality, so that the high-frequency response suffered somewhat in local reception and some interference was permitted on distant transmissions. Variable selectivity obviously completely removes this drawback, and permits the user

Chassis of the Dynatron Ether Knight.

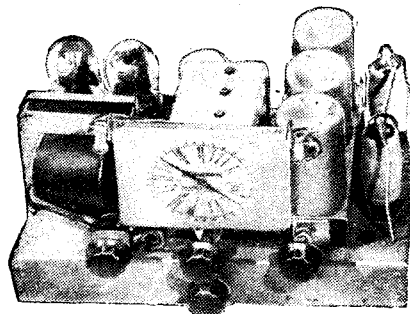

of the tuned circuits in order to prevent excessive peaks in the response curve from being obtained. Arrangements are also made for ensuring that for any one setting of the variable selectivity switch,

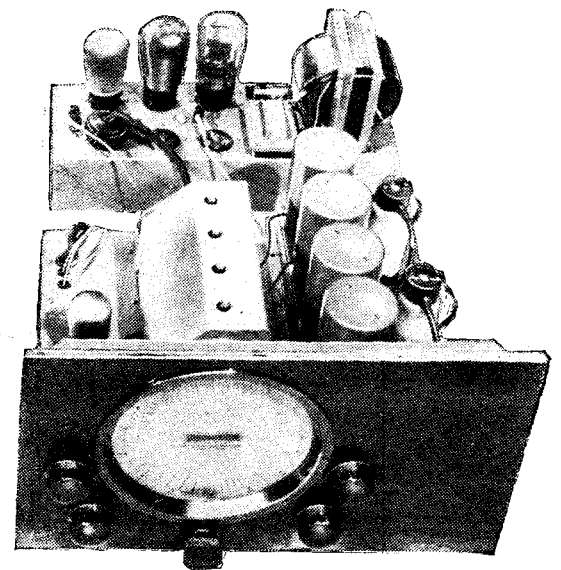

New Set Designs

Modern Circuit Refinements.

prising the IF transformer are permanently fixed with a degree of coupling giving the maximum selectivity desired. A third coil is mounted between them and is untuned, but has a variable resistance connected across it. By varying this resistance the amount of energy absorbed from the tuned circuits can be altered, and hence their effective HF resistance and the response curve.

The R.G.D. Model 704 has a different system from the larger set of the same firm. An intermediate frequency of 110 kc/s is used, and the selectivity is changed by switching one IF transformer out of circuit and replacing it by a resistance coupling. Variable coupling between the coils of an IF transformer is adopted in the case of the Philips 575A receiver, and the frequency response curve of the set shows that for a drop of 10 db. the upper limit can be varied between about 3,000 c/s and 8,000 c/s. A similar arrangement is adopted in the case of the Invicta AC/45 of Orr Radio, and this is one of the smallest receivers to include it,

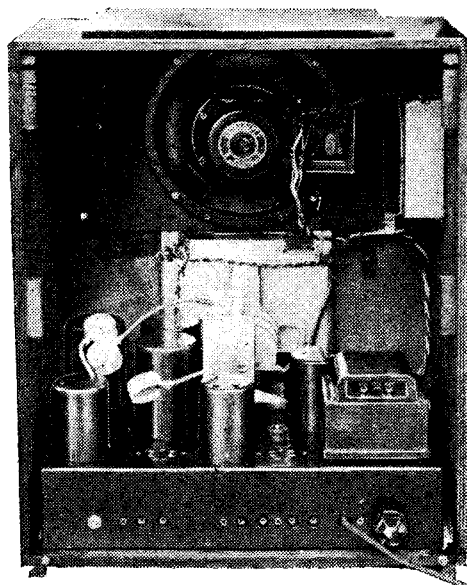

The Burndepth All-Wave receiver.

having only three valves apart from the diode detector and the HT rectifier. The Cossor 836 equipment is provided with a switch giving two different degrees of selectivity.

All-Wave Receivers

Turning now to the second trend, one or more short-wave bands have found their way into a surprisingly large number of sets. The number of short wave ranges fitted varies considerably, but the method

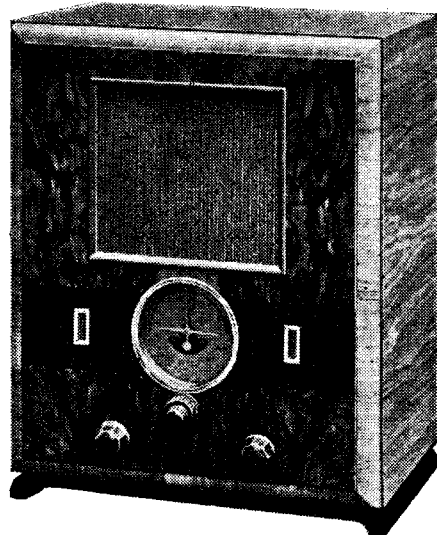

The Alba All-Wave Superheterodyne.

of reception is usually the same as on the medium and long wavebands, the coils being replaced by others of suitable inductance. The R.G.D. Model 1203 has short-wave coils wound on special insulating material, and a Hartley type oscillator is used in the two-valve frequency-changer. The HF stage operates on all wavebands, and a special gang condenser is used having split stator sections. Each section has two banks of fixed plates of which only one is used for short waves and both for the other bands. In this way a tuning capacity of some 0.00015 mfd. is available for short waves and some 0.0005 mfd. for medium and long waves. Two short-wave bands are included and switching is employed for the change-over.

The Allwave International receiver is a double-superheterodyne having a first intermediate frequency of 1,600 kc/s and a second of 80 kc/s. Two signal-frequency circuits are used, and there is an HF stage which functions on all five of the wavebands. A triode-hexode is used for the first frequency-changer and an octode for the second.

The Burndepth all-wave set, however, is more conventional and has three wavebands, 17.5/53, 185/550, and 800/2,000 metres. There are two signal-frequency circuits and two IF stages are employed. A dual-ratio tuning control is used in order to simplify short-wave tuning, and the gang condenser is floated on rubber supports to eliminate microphony. The Unirad sets have two short wavebands, 15/29 and 27/64 metres, in addition to the medium and long, and in these a gang condenser with brass vanes is rigidly mounted to a brass chassis. The Decca

set has an HF stage and two signal-frequency circuits, and there are two IF stages following the frequency-changer. Very thorough screening is adopted. The R.A.P. Transatlantic receiver, however, has a band-pass pre-selector feeding a heptode frequency-changer, and the intermediate frequency is 117.5 kc/s. One short-wave band of 19.5-52 metres is included. Five wavebands are included in the Ever Ready 5011 receiver, and it covers 13/2,000 metres. A dual-ratio tuning dial is fitted.

The Philips 537A receiver, which has already been mentioned as including variable selectivity, has a short-wave tuning range of 16/50 metres, and a signal-frequency HF stage is fitted. This set is noteworthy in that the coils are individually screened, and the set is remarkably compact in view of the many features which it includes. The Kolster-Brandes sets are all of the medium- and long-wave type, but they are specially arranged for use with a short-wave converter which effectively turns any model into an all-wave set. A similar procedure is adopted by Dynatron, and the converter marketed by this firm has an HF stage before the frequency-changer. Two signal-frequency circuits are used with iron-core coils which are claimed to be more efficient than air types. In order to avoid microphony both gang condenser and coils are mounted on absorbent material.

QAVC

A refinement which is finding its way into receivers of all classes is QAVC. This takes two general forms, although the actual methods are very varied: true QAVC or muting between stations, and noise suppression by means of a sensitivity

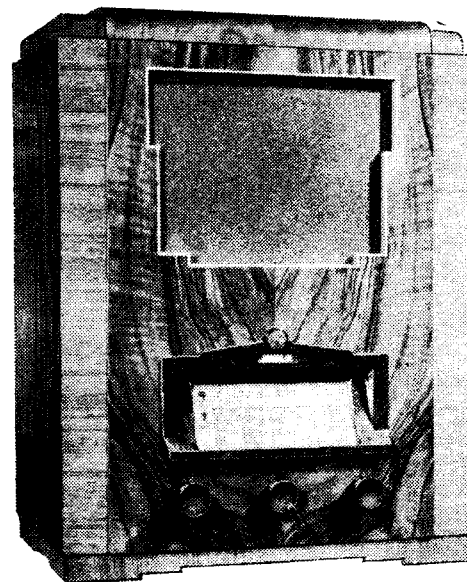

The Philips Model 575A with QAVC.

Analysis of the New Set Designs—

limiter. The former usually means that the detector or a valve in the amplifying chain is made automatically inoperative when the set is not tuned to a signal so that the receiver is quite silent, whereas



The H.M.V. Model 441 with QAVC.

with the latter the sensitivity is reduced, usually by a switch, while tuning so that background noise is not obtrusive.

The H.M.V. High-Fidelity Auto-Radiogram includes a muting circuit in which the last IF valve is biased beyond current cut-off in the absence of a signal. The controlling system is fed through very selective circuits so that the receiver is quite silent until it is almost exactly tuned to a signal, and possible distortion due to mistuning is very largely prevented. QAVC is also included in the Models 441 and 444 of this firm. In the R.G.D. Model 1203, muting is operated by the AVC system and controls an LF valve. A diode detector provides the initial AVC bias, but this is amplified by a DC amplifier before being applied to the valves, and a further DC amplifier is included for the muting circuit. The Cossor 836 has muting applied to an IF valve, and the AVC system controls an LF stage in

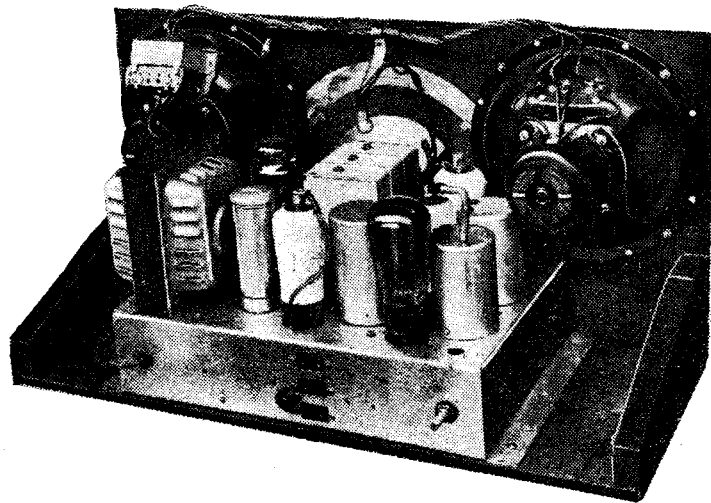

Chassis of the C.A.C. Austin AC Super Six.

addition to the early valves. In the Kolster-Brandes sets muting is applied to an LF valve, while the detector is con-

trolled in the Allwave International set. A very simple arrangement is used here. A push-pull diode detector is included and biased negatively by the voltage drop across a resistance through which flows the anode current of the valves controlled by the AVC system. When a station is tuned in, the anode current falls by normal AVC action and the detector bias is reduced. A similar arrangement is employed in the Mullard MU35 receiver.

A detector control of a more elaborate nature is used in the Pye T9 receiver. Here it is the change in anode current of the triode section of a duo-diode-triode, which also acts as an LF amplifier, which releases the bias on the diode detector. A detector control, but of a different nature, is used in the C.A.C. sets. A triode is arranged to have a very high input capacity which can be controlled by its grid bias. This triode is shunted across the detector load resistance, and in the absence of a signal reduces the sensitivity and high-frequency response. Thus, although complete muting is not obtained, inter-station noise and sideband splash are greatly reduced.

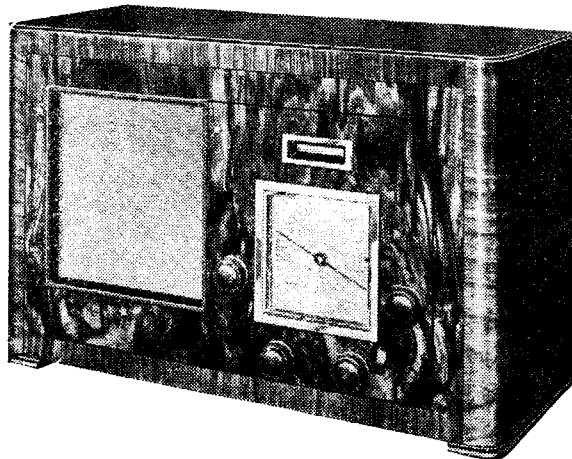

The G.E.C. Fidelity AC5 receiver.

The three-valve superheterodyne is a good example of the trend towards uniformity in the small class of receiver.

Nearly all sets of this type have the same arrangement of valves—a frequency-changer, an IF stage, and an output pentode. The detector is not included as a separate valve here, for it is just as often a part of the output pentode (duo-diode-pentode) as a separate valve. In either case it is a diode and contributes nothing to the amplification. Two signal-frequency tuned cir-

cuits precede the frequency-changer, and there are two IF transformers each including two tuned circuits. Delayed AVC is

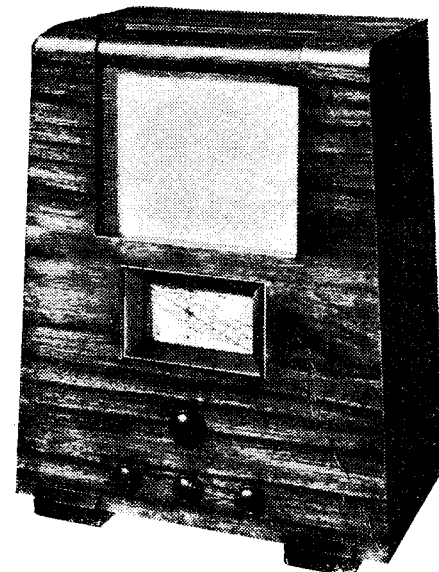

The Bush SAC 21 receiver.

obtained from one of the two diodes and the other acts as the detector.

The variations between the specifications of sets of this type are chiefly in minor matters; some are for AC mains

only, others are designed for AC or DC supplies; some have noise-suppression switches, others have not; some have a visual tuning indicator of the neon type, others have a meter indicator, or none at all. The cabinet varies, as does the tuning dial and the arrangement of the controls. The performance varies also in spite of the similarity of the general design, for a set is not completely specified by the arrangement of valves and coils, or by its circuit diagram, but by the values assigned to the components, the quality of workmanship,

and the care in initial adjustment. Matters of this nature which are not apparent at a passing glance or from the specification have a marked effect upon the price of the instrument.

The Ever-Ready Model 5008 is one example of this class of receiver. It is of the AC/DC type, and a noise-suppression circuit is included. The Bush SAC21 is an AC set with a delayed AVC; the duo-diode and output pentode being

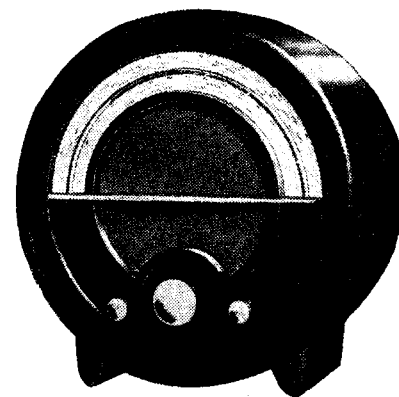

The Ekco AC76 with a duo-diode detector.

Analysis of the New Set Designs—

separate and not combined. The operating potential is adjustable by means of a switch to give a form of QAVC. Another example of this class is the Ekco AC76, and here again a separate duo-diode is used for the detector. The Heayberd 4-Point receiver has the same arrangement of valves, but the cabinet style is entirely different, and a mains filter is fitted.

The Marconiphone Model 236 differs somewhat in that the IF stage is reflexed and acts also as an LF amplifier. The three valves thus function as frequency-changer, IF amplifier, detector, AVC source, LF amplifier, and output stage! It is an AC/DC set. The Decca receiver

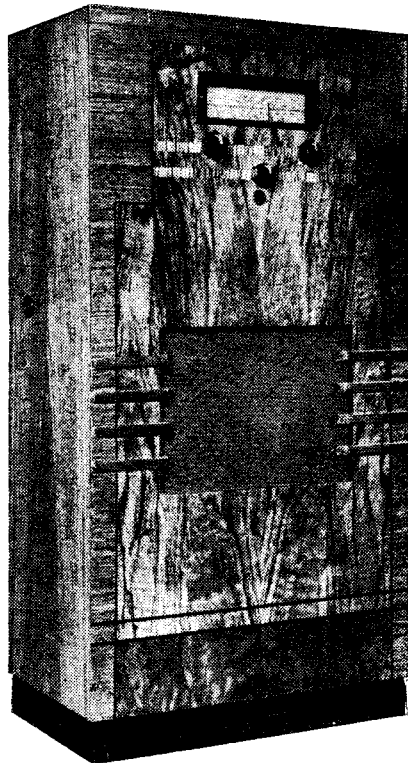

The Marconiphone Model 236 AC/DC receiver.

has a heptode frequency-changer, an IF stage, and a duo-diode output pentode. It is available in both AC and DC models. The Cossor 364 receiver is for AC only and incorporates a separate diode detector, while a neon tuning indicator is fitted. A battery set of similar design, the 366A, is also available.

The Ferranti Nova and Lancaster receivers are of similar general design with a duo-diode-output pentode; the latter, however, is fitted with a tuning indicator and a noise-suppressor switch. This same arrangement of valves is adhered to by the G.E.C. in the Superhet AC4, in which an intermediate frequency of 125 kc/s is used. The McMichael 253 receiver with a duo-diode-output pentode incorporates a triode-pentode frequency-changer instead of the more usual heptode or octode. This is also embodied in the Ultra Model 25, which is fitted with a neon tuning indicator.

This season's car sets might really have been planned with no other object but to help us to illustrate the various practical

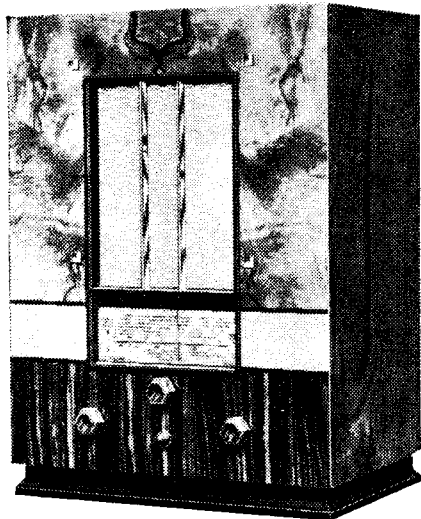

The Ferranti Lancasteria superheterodyne.

forms that this highly specialised form of receiver can assume. All schools of thought are represented in the models shown, and it would be hard to find a vehicle in which one or other of the sets could not be neatly installed.

Car Radio Layouts

The latest of the car receivers, the Marconiphone Model 336, is sub-divided on rather unconventional lines into three units. First comes the receiver proper, and secondly a power supply unit which also houses the speaker. Lastly there is a remote control panel which operates from the steering column through Bowden cables, which can, if required, be extended to a distance of 12 feet. High-tension voltage is derived from the car battery through a vibratory step-up generator, the output of which is rectified by a valve.

Basically, the circuit arrangement is

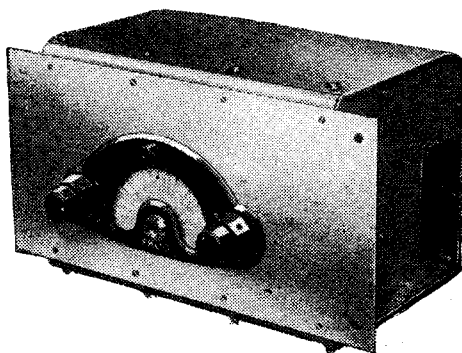

Receiver unit of the Ekco car set.

representative of almost all sets; it embodies a signal-frequency HF stage to compensate for the small pick-up of a car aerial, but from that stage onwards is similar to the typical small domestic superheterodyne. High sensitivity is obviously needed, and the figure relating to the Marconiphone set is given as better than 1 microvolt per metre.

Both the C.A.C. and G.E.C. sets are of the single-unit type, in which the receiver, speaker and power supply equipment are housed in a single case. These sets are remotely controlled, but the Ekco

car receiver unit is intended for mounting in the cubby hole in such a position that its control knobs are directly accessible to either the driver or the front-seat passenger. With this object in view, the set itself has been made extremely compact, space having been saved by housing the speaker and HT supply unit in separate cases, making three units in all.

It will thus be seen that the more or less conventional car set can be arranged in three distinct layouts, each of which has its own particular advantages. At the present time it would be rash to hazard an opinion as to which is the best, and there seems plenty of room for all.

A distinctly unconventional method of attacking the car radio problem has been adopted for the Decca "Home and Car" sets, which can be operated either from the car battery or from the household AC

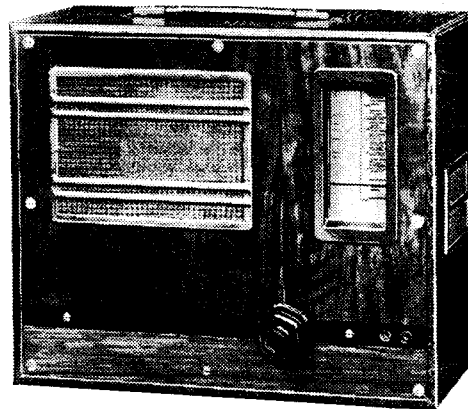

The Decca set, for operation either from a car battery or the household mains supply.

mains, thus extending their sphere of usefulness. Naturally the sets are of the single-unit directly controlled type, and the method of changing over is extremely ingenious, both electrically and mechanically. The appropriate connections for either form of supply are made by inserting a multi-pin cable, and, for working from the car battery, the built-in generator through which HT voltage is supplied is automatically put into operation. Models with and without a signal-frequency HF stage are available.

Midget Frame-Aerial Sets

Although the portable set has been with us for many years, the average specimen is far too heavy and bulky for the descrip-

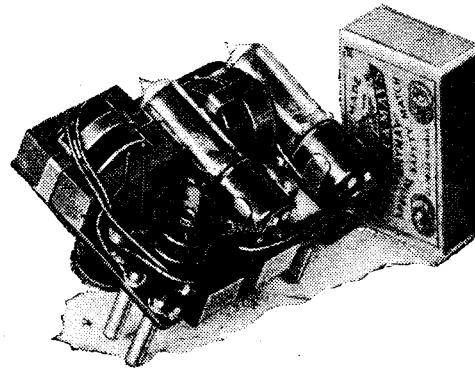

The smallest "chassis"; the Empiric Pocket Set.

Analysis of the New Set Designs—

tion to be truly indicative of its real scope. But this year a number of really portable sets, small and light enough to be carried almost anywhere, have made their appearance. It is only bare justice, however, to

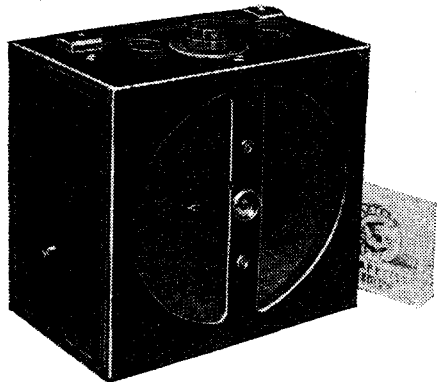

The Wayfarer loud-speaker portable weighs only 9 pounds.

say that these sets have largely been made possible commercially by the introduction of the Hivac midget valves, which, in addition to their small size, are extremely economical in filament current.

The Editor of *The Tailor and Cutter*, whose illuminating and often caustic comments on men's clothes are so widely quoted by the general Press, would probably take us to task if we suggest that there is now no reason why every reader should not carry with him his own personal set. But, apart from the fact that it may spoil the hang of a well-fitting jacket, there is no reason why the Empiric Pocket Set should not be so used; it is literally of pocket size, and weighs under 2 lb. Technically the set is of interesting design, the super-regenerative circuit employed being based on that of the Brighton police receivers, of which the sensitivity is high enough to operate a call-bell relay at quite considerable ranges, in spite of the microscopic signal pick-up of the tiny built-in frame aerial.

The Pocket Receiver and others of the same general type of course provide headphones reception only. But several true portables for loud speaker reproduction are now available; both the Empiric and Wayfarer models (the latter shown

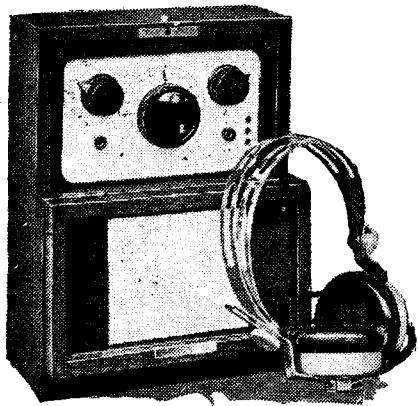

The Mite receiver; a miniature set covering short and normal wavelengths.

by London Electric Appliances, Ltd.) use a circuit arrangement comprising a single HF stage followed by a regenerative detector and two LF stages. In both these sets, compactness is achieved both by use of the midget valves already mentioned and by a general reduction in size of components and accessories rather than by any radical innovation in circuit design.

Another very interesting trend in design is exemplified in the Allwave International "Mite," a miniature "all-wave" set for headphone reception. One of the models shown embraces medium and short waves (five bands in all), while another, perhaps more suitable for general use in this country, covers medium and long broadcast bands as well as short waves. Super-regeneration is employed for the reception of the shorter wavelengths, but the quenching circuit is automatically switched out of operation for work on the normal bands, which is carried out by an arrangement of the "straight" det.-2LF regenerative type.

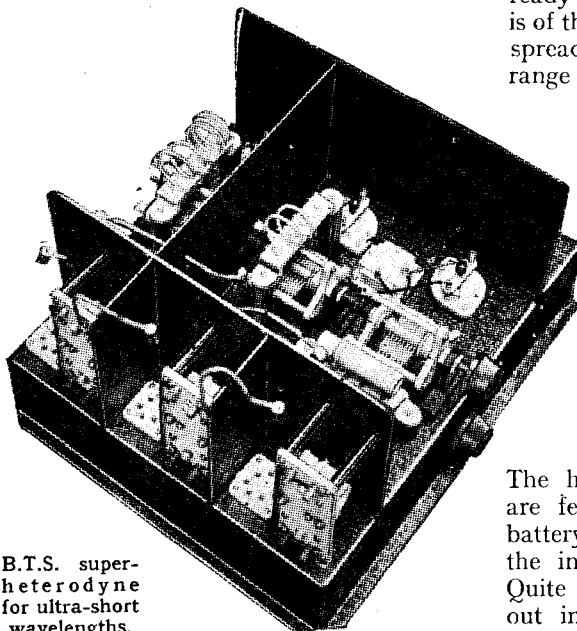

B.T.S. super-heterodyne for ultra-short wavelengths.

Short-wave Sets

Receivers covering one or more short-wave bands in addition to the normal broadcast wavelengths are now produced by many firms, and their technical features have already been discussed. But purely short-wave sets of the type with which we are here concerned are surprisingly few in number when the undoubted interest that exists in "sub-broadcast" bands is taken into account. Even those shown were seldom in completed form, being supplied either as kits of parts or exhibited in the form of

sponsored circuit arrangements by, the manufacturers of the principal components used in their construction.

An exception is to be found in the Unirad short-wave superheterodyne, an interesting receiver intended largely for overseas work and mounted in a "tropical" cabinet.

Another short-wave set is the Mavox B7S, covering waves between 12 and 68 metres. This also employs a superheterodyne circuit.

Among the "kit" sets, some very advanced designs for the ultra-short bands are sponsored by Eddystone. The most interesting is probably the six-valve superheterodyne tuning normally from 50 to 62 mc/s, but which can be adapted to work up to 100 metres. Another superheterodyne for the 5-10 metre band was shown by British Television Supplies to illustrate the use of the special components made by this firm.

The Lissen short-wave kit set, which differs from those already discussed in that all the components are supplied ready to assemble (complete with valves), is of the det.-2LF type and embodies band-spread tuning; the coil is of the two-range type with waveband switching.

Amplifiers

The scope of the public-address amplifier has been extended by the introduction of portable models, of which the latest types are very ingeniously adapted to work from a car battery, although not all the equipment that falls into this category is intended for operation only in the vehicle itself.

The heaters or filaments of the valves are fed with current directly from the battery, which also supplies HT through the intermediary of a rotary generator. Quite large outputs are obtainable without imposing an excessive load on the battery. Among makers of this type of apparatus are Ardente, Ossicaide and Film Industries; the equipment developed by the last-mentioned firm is adapted for permanent or semi-permanent installation in the car, and is so arranged that the

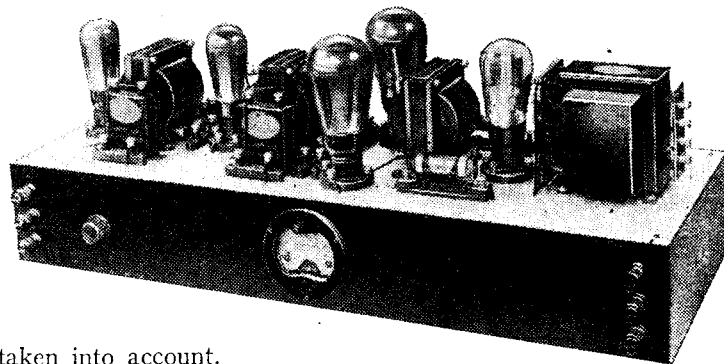

Ferranti Constructors Amplifier, Type AC6C, which provides sufficient magnification for operation with a microphone.

Analysis of the New Set Designs—

amplifier itself may be mounted out of the way under one of the seats. A microphone and a specially designed loud



Three-valve schools receiver by R.I.

speaker for fitting under the bonnet of the car completes the equipment.

The new Tannoy amplifier Type GUB10 is an extremely versatile piece of apparatus, being adaptable for working from a 12-volt car accumulator or from either AC or DC mains, depending on which type of supply unit is employed with it. Both units are small in size, and are easily connected up through multiple plugs.

Apart from these mobile or universal amplifiers, several battery-operated types have now appeared. One of the most interesting of these comes from the Special Products department of the Marconiphone Company; the feature of the equipment is not so much an exceptionally large output from the amplifier as exceptional efficiency in the associated loud speaker, which is mounted in a semi-directional baffle box. The Film Industries "Baby" battery amplifier, which employs a Class "B" circuit, has been modified since last year, and now has a rated output of 3½ watts. The same firm also makes a universal AC-DC amplifier, which, like the majority of its type, employs push-pull pentodes (rated at 6-7 watts) in the output circuit.

Although general-purpose amplifiers have been "cleaned-up" and improved in detail, few, if any, include any technical developments with which the average reader is not familiar. The Sound Sales 30-watt amplifier, however, includes an unusual circuit, described as "low-loading," which offers the advantage of great volume combined with economy. A series of amplifiers which are unusually adaptable both with regard to type of input and to output matching were shown by R.G.D., who also produce a gramophone amplifier on the lines of their well-known sets.

A few years ago we used to refer to the three-valve HF-det.-LF circuit as the "standard" arrangement for popular sets. Since then this circuit has been displaced to a great extent by the 3- or 4-valve super-

heterodyne, but there is a distinct tendency for it to "stage a come-back" this season.

The "Straight" Set Revival

On the stands of many well-known firms new sets of the type under discussion figure quite prominently. This tendency will be generally welcomed provided that it is made quite clear to the would-be purchaser that straight three-valve sets cannot compete with the superheterodyne either in sensitivity or selectivity, but are suitable for satisfying the requirements of those who put local-station reception first, with long-distance work as quite a secondary consideration. For this type of wireless user the straight set is eminently satisfactory; in fact, it is likely to be better than a cheap superhet, and should certainly be much more reliable.

Generally speaking, the sets have few features of technical novelty. The cheaper mains versions (from, say, £7 to £8) generally embody only two tuned circuits, while the more expensive ones (£8 to £9) are often equipped with a band-pass filter, generally at the aerial end. An exception to this rule is found in the C.A.C. set, where the filter is employed as an inter-valve coupling, with the advantage that the conditions under which it will work

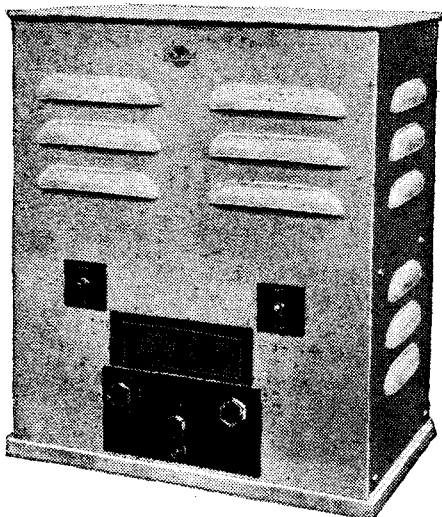

Severely practical: the Marconiphone steel-cased receiver for schools or institutions.

can be more exactly predetermined. A similar arrangement is to be found in one of the Kolster-Brandes sets.

Tuning coils of unusually high efficiency are used in the Marconiphone Model 235, which also offers a rather greater rated output than the majority of its type. A special "Droitwich rejector," which may be included in the aerial circuit by making connection to the appropriate terminal, is a feature—and a very sensible one—of the Ferranti sets. The high-power station is a bugbear to listeners in the Midlands, and has led to the introduction by at least one firm (Burgoyne) of a special "Midlands" model, at a slight extra cost, including a rejector.

A feature of this year's show is the number of receivers designed to conform with the requirements laid down by the Central Council for Schools Broadcasting.

Separate loud speakers are employed and the sets are designed both internally and externally for the special purpose they are to fulfil. With regard to circuit details, no particular arrangement is standardised, but in general the sets resemble medium-range broadcast equipment of the better

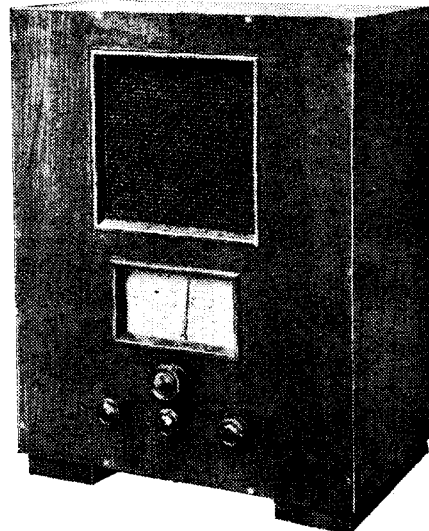

The Orr Radio Fisherman's set.

type; a high standard of reproduction is rightly demanded.

Circuits for Special Purposes

School sets of different types form the main R.I. exhibit. Both superheterodyne and "straight" models are made; the latter, in the mains version, includes an HF stage, regenerative detector, and pentode output. There is a two-way tone-regulating switch, and the controls are protected by a door which can be locked.

All the sets are available with gramophone equipment and are housed in plain teak cases to suit the surroundings in which they will be used. The Marconiphone "Special Products" set, designed either for schools or institutions, is provided with a steel case.

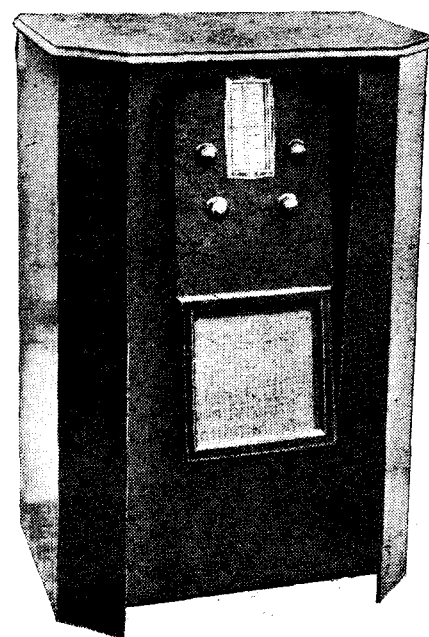

A short-range "quality" set: Hartley Turner Model CS7A

Analysis of the New Set Designs—

Radio-gramophones designed specially for schools use are made by Haynes and Tannoy. The former is available with various types of chassis; either one or two HF stages and either 6- or 14-watt output units may be chosen.

Another recent special-purpose receiver is the Orr Radio Fisherman's Set, which was originally produced for trawlers but which has since found many other applications. The set is for battery operation and covers wavelengths between 100 and 200 metres (yacht and trawler telephony band) as well as the normal broadcast frequencies. To withstand the buffeting that it is likely to receive when installed on a small vessel, the chassis is rubber-mounted and is housed in a strong teak cabinet.

The Hartley Turner sets, which are specifically designed either for short- or medium-distance reception, and are not general-purpose broadcast sets in the ordinary sense, can best be dealt with under the present category. The most interesting feature of the present season's models is the provision of a simple form of AVC in the short-distance chassis, not with the usual object of overcoming fading, but to ensure that the detector will be operated under correct conditions even by an unskilled user. A chassis of this type is included in the new console receiver. For the medium-range sets Hartley Turner still use the principle of sharply tuned straight circuits followed by tone correction.

In the Haynes series of quality receivers, which, by virtue of the unit system developed by the firm, may be fitted with various tuner and output units to meet the users' requirements, the straight circuit is employed exclusively this year, with resistance-coupled "duo-phase" LF amplification.

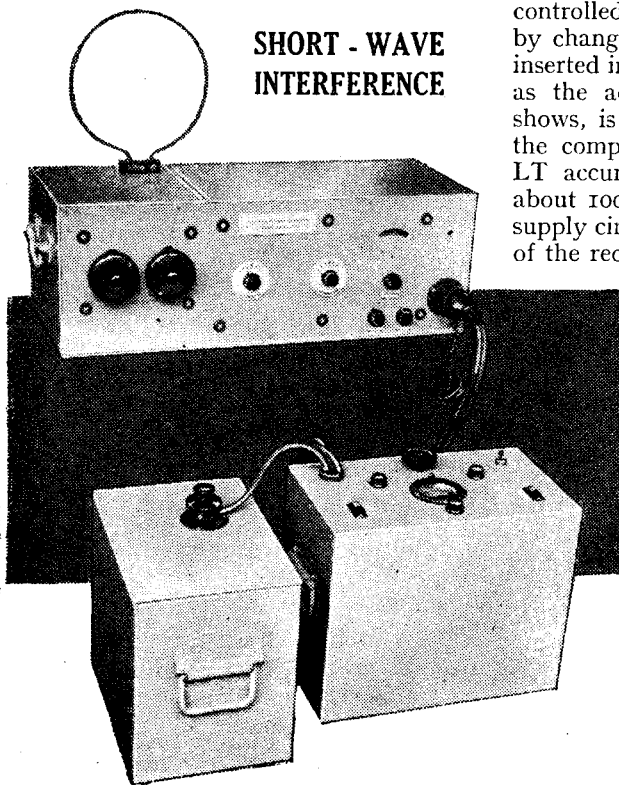

SHORT - WAVE INTERFERENCE

Large-Deflection Tuning Indicator

By R. S. NICOLL, Grad. I.E.E.

A Useful Addition to Existing Receivers

ATUNING indicator in moderately skilful hands does something more than merely show that the receiver is accurately tuned to an incoming signal. Up to a point, it is a "performance meter," giving at least some indication as to whether the receiver is working properly and, moreover, it is a valuable aid in making trimming or other adjustments.

When AVC is fitted it is an easy matter to obtain clear and definite indications of the effect of adjusting the circuits to resonance with an incoming signal, as the carrier causes large variations of anode current from almost nothing up to several milliamperes. The alternative plan recommended for simpler sets is to connect a meter in the detector anode circuit; though well enough in its way, the trouble with a grid detector is that the changes of anode current under the influence of an incoming signal are relatively small and so clear indications are not always obtained from the meter.

Magnifying Voltage Changes

It is the purpose of this article to describe a device that magnifies such changes that do take place in order to make them clearly perceptible. The device suggested is here shown diagrammatically; it is, in effect, a DC amplifier controlled by variations of voltage set up by changing current through a resistance inserted in the detector anode circuit, and, as the accompanying "List of Parts" shows, is not expensive. In addition to the components given, a separate 2-volt LT accumulator and an HT battery of about 100 volts are needed, as the power supply circuits must be isolated from those of the receiver.

Layout is unimportant, and all the parts can be accommodated in any small box that may be available. The controlling switch should, however, be accessible as there is no point in wasting anode current when indications of tuning are not required.

This apparatus, shown at Olympia, has been developed by the Electrical Research Association for investigating electrical interference as it effects short-wave reception.

In operation, it is convenient to arrange matters by adjustment of the 5,000-ohm potentiometer so that the pointer of the milliammeter stands normally at the most easily read part of the scale—that is to say, at about the middle portion. When the

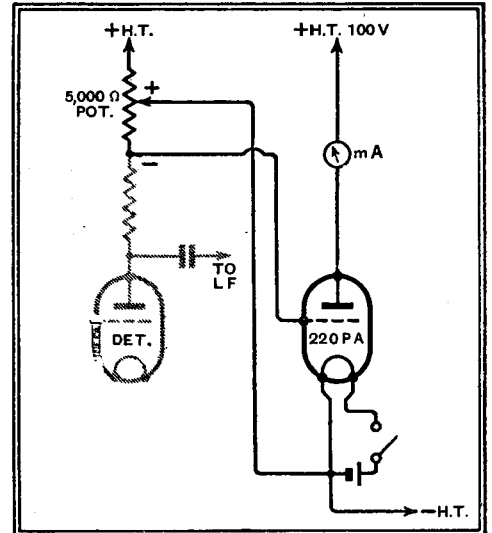

Circuit diagram of the indicator, showing connections to an existing receiver. Small voltage changes taking place in the anode circuit of a grid detector under the influence of an incoming signal are magnified, and cause easily discernible variations of the meter.

current in the plate circuit of the detector valve is reduced by a carrier wave the voltage across the potentiometer drops slightly and so the bias on the controlling valve is reduced and a corresponding increase of plate current taken by this valve causes the milliammeter to move appreciably.

It is advisable to avoid moving the potentiometer slider too far towards the "negative" end of its travel as otherwise the meter may be overloaded. Further, the set should be switched on before the indicator valve in order to avoid a similar rush of current through lack of negative bias.

Although the general type of valve suggested is very satisfactory, it should be pointed out that useful indications—very much more definite than would otherwise be obtainable—are given with almost any type of three-electrode valve as a controlling medium.

List of Parts Used by the Author

- 1 Milliammeter, 0.8 mA. (Bulgin).
- 1 Potentiometer, 5,000 ohms (Bulgin).
- 1 Valve holder, 4-pin (Graham-Farish).
- 1 On-off toggle switch (Bulgin).
- 1 Valve, Type 220PA (Cossor).

A Good Start for the New Set

Modern Aspects of the Installation Problem

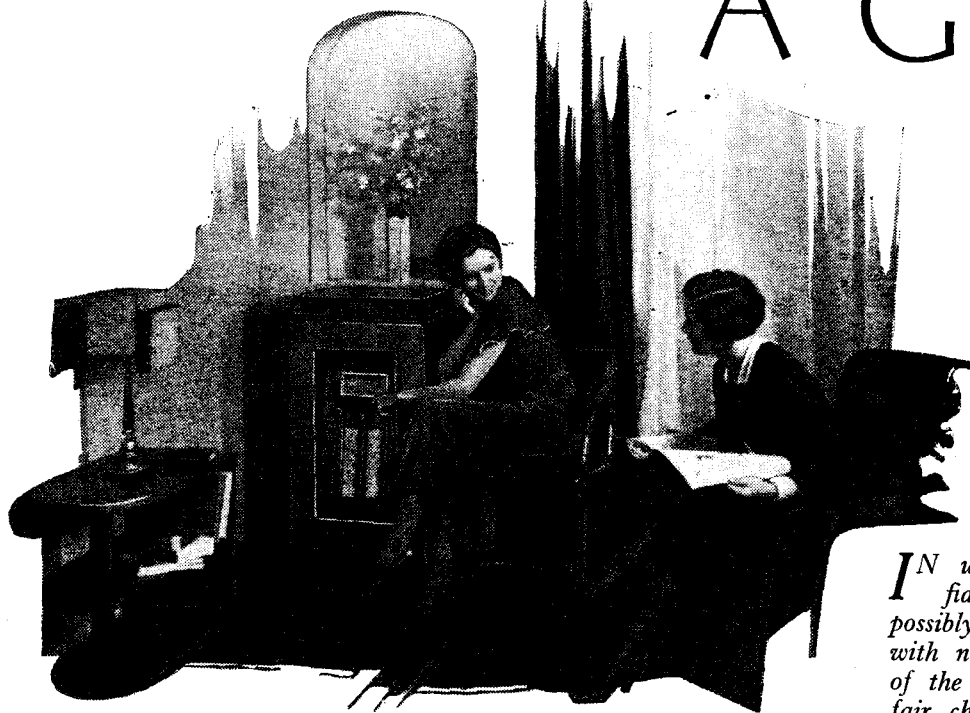

By H. F. SMITH

IN unfavourable circumstances, a good "high-fidelity" set may sound no better—and possibly much worse—than a cheap instrument with no real pretensions as to quality. Buyers of the new receivers are urged to give them a fair chance by observing the simple precautions described in this article.

IT is the experience of the writer that, if a receiver is not properly installed at the very beginning of its life, it never will be. For this we have to thank the inherent tendency to put off a non-essential job of work, the vast reserve of sensitivity of the average modern set, and the lack of any standard of comparison.

In spite of improved receiver designs, careful installation is from some points of view even more desirable than ever, though the reasons for it are rather different. At one time our sole aim was to avoid the loss of precious microvolts of incoming signal voltage in order that distant transmissions could be received intelligibly; now we strive after a good signal-to-noise ratio and freedom from interference. The better our sets, the more important do these matters become, and it is a fact that many receivers that truly deserve the description of "high-fidelity" are condemned solely because they have not been given a fair chance by their owners—or worse still, by trade demonstrators who should know better—to show what they can do.

Preliminaries

As always, the aerial is the first consideration. We can bring up the volume of reproduction of an incoming signal to a given level either by (1) increasing aerial efficiency and thus the voltage applied to the set; (2) by increasing magnification inside the set itself. That the first of these alterations is the better is obvious when it is realised that valve noises (and so background noises) are proportional to the amount of magnification demanded from the valve.

Without advocating that it would be

economic or in any way desirable to carry to extremes this idea of obtaining the maximum possible aerial efficiency, it is suggested that a little thought should be given to the matter. This is not the place for a treatise on aerial construction, and little useful purpose would be served by attempting to deal with the matter in detail. But the reader who is interested in the subject will not go far wrong if he bears in mind the underlying principles: that the aerial should be as high as can conveniently be arranged above earth and earthed objects, well clear of obstructions, and spaced by the maximum possible distance from such potential sources of interference as internal electric light wiring and external power cables, etc. It is a good plan to try to create a mental X-ray picture of the building with its water pipes and wiring, and so to position the aerial that it is as far removed as possible from them, and is never running parallel with them for long lengths.

In coming to a decision, one is naturally influenced by the intended position of the set in the house; it is a waste of time to take pains to keep the aerial wire clear if the lead-in connection is allowed to wander at random through an intense field of interference inside the building. This means that the aerial should lead as directly as possible into the room in which the set is to be placed.

As in the case of the aerial, we still need a good earth connection almost as much as ever, but, again, for rather different reasons than formerly. A poor earth may provoke hum, and, in a few cases, incipient instability, which will have a

seriously adverse influence on the behaviour of the set. Contrary to the usual belief, a connection to the water main is better, from the point of view of sheer efficiency, than a direct "earth" through one of the small earth tubes of commerce, but is slightly more likely to introduce electrical interference. The ideal arrangement is a connection to a really large and deeply buried sheet of metal; failing that, several earth tubes "in parallel" or a good water pipe connection will generally be good enough. If the water pipe is chosen, it is wise to use a proper clip (after having cleaned the pipe) and not to depend on a twisted wire.

We have now proceeded far enough to determine by trial and error the best position in the room for mounting the loud speaker (or the set, when the two are combined) from the point of view of distribu-

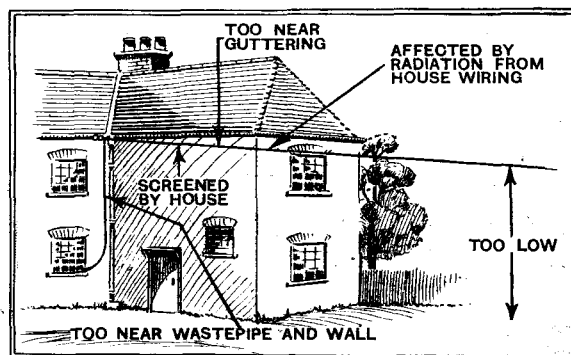

How not to do it: points to be observed when planning an aerial.

tion of sound. This is a far more important matter than is usually realised, and it is no exaggeration to say that in certain circumstances the effective volume can be almost doubled by a wise choice of position. Generally speaking, loud speakers

A Good Start for the New Set—

are particularly directional with regard to high notes, and it will help towards brilliant and natural reproduction if matters can be so arranged that listeners can comfortably manage to sit more or less in line with the axis of the diaphragm.

Having reached the best compromise—and it is almost certain to be a compromise—in the matter of position, the time has come for making permanent aerial, earth, and mains connections to the receiver. More often than not, this is done by untidy lengths of flexible wire wandering haphazard about the room. Besides being a possible source of losses and interference, these straggling wires are often positively dangerous, as they introduce a risk of

either short-circuits or else cause the receiver to be pulled over and

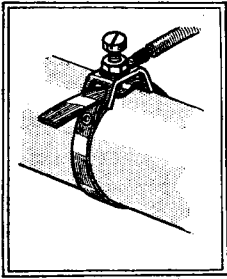

A twisted wire earth connection to a water pipe is bound to deteriorate; a proper clip makes a permanent job, and costs only a few pence.

damaged. It is well worth while having a proper electrical outlet wired to a suitable point on the skirting board; near it, but not too near, may be mounted suitable sockets to which the aerial and earth terminals are connected by short leads which can generally be concealed and secured so as to prevent the possibility of damage. An excessively long mains lead is to be avoided; one often meets cases where modulation hum is induced into the circuits through the surplus length being coiled up in close proximity to the receiver.

Although tidiness is generally suggestive of efficiency a note of warning should be sounded at this point. The various leads should not be bunched together into a single cable; the mains should be separated from the aerial and earth leads, which should themselves be spaced from each other by about $\frac{1}{2}$ in., even for short "runs."

Methods commonly provided for joining wires to plugs and terminals are not always beyond reproach, and the possibility of improving the permanence of the job by soldering or using proper tags may be considered. It will also be wise to make sure that all plugs fit tightly into their sockets, and if necessary to open out the pins.

Trimming the Aerial Circuit

Turning to the receiver itself, the odds are heavily against the tuning of the input circuit being accurately aligned when it is finally connected to the user's aerial. It will be easy to appreciate that the manufacturer, when making initial adjustments in the factory, has to use an arbitrary standard of capacity which may differ considerably from the user's aerial capacity. Although perhaps only one-twentieth (as a rough approximation) of this difference may appear across the tuned circuit, it

may be quite enough to impair performance, and so it is always worth while to consider whether the aerial circuit should be re-trimmed.

Now the complete trimming or re-gang-ing of a modern set is no task for the novice. But the adjustment of a single circuit is easy enough, and anyone with a slight knowledge of wireless matters can undertake it, especially if helped by the tuning meter which is fitted to so many sets nowadays. The procedure is to tune in a station at the lower end of the medium band as accurately as possible, and then, by adjustment of the trimmer controlling the aerial circuit, to endeavour to increase signal strength still further. If this can be done we have proof positive that our efforts have not been in vain; if it cannot, no harm will have been done.

Valve Contacts

If the work of installation has been well and truly carried out on the lines suggested, there is every chance that the receiver will remain undisturbed for a long time. But, during initial testing, packing and repacking, etc., the valves have probably been removed several times from their holders, and it is possible that their springy

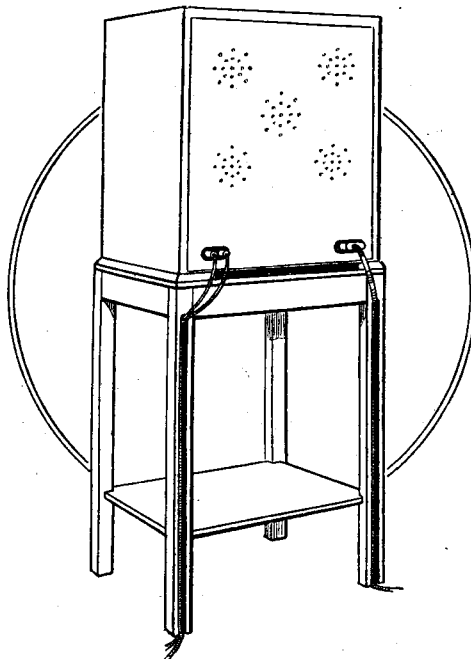

An idea gleaned from the Electrico stand at Olympia; wiring to the receiver is secured safely and neatly in grooves in the legs of the table.

split-pins have begun to lose some of their resilience. To be on the safe side, they may accordingly be opened out slightly, and gently, as an insurance against the development of bad contacts.

There is a right and wrong way of carrying out even this simple operation. The obvious method of restoring springiness—by thrusting a penknife blade into each of the slots—introduces a slight risk of breaking the fragile connecting wire which passes through the hollow pin and is soldered to its point. To avoid this risk,

the sharp point of a small screwdriver may be inserted into each slot and then given a slight twist. No risk of breaking the lead-out wire exists provided that the tool is not inserted too far.

In moderately favourable circumstances, faithful observance of the precautions sug-

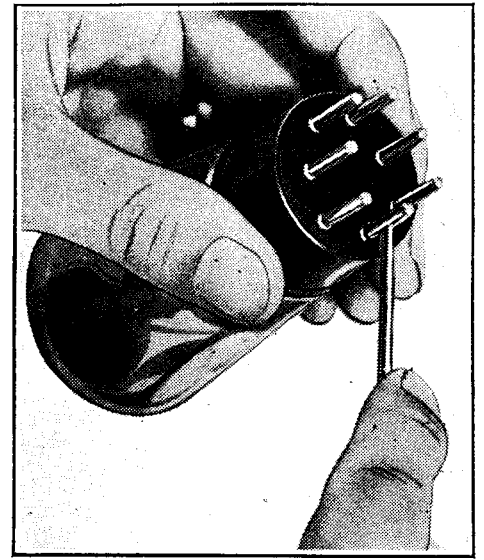

The safest way of restoring springiness to valve pins.

gested should ensure good and interference-free reception. But if there are signs of mains-radiated interference—which will generally manifest itself most clearly when the receiver is tuned to a weak transmission, and at the same time adjusted for maximum high-note response—it is well worth while fitting a condenser suppressor to the mains input to the building. The reader who goes to the slight trouble and expense of doing this can consider himself particularly unfortunate if a worthwhile reduction in background noises does not result.

**New Three-valve
Portable****A Frame Aerial Set to be
Described Shortly**

IN last week's issue of our contemporary, *World Radio*, an article appeared under the title, "On Tour with a Portable Headphone Set," describing the performance of a very compact and efficient three valve frame aerial set. By arrangement with the designers of the set, *The Wireless World* will publish full constructional details in an early issue.

We feel sure that this receiver will have a wide popularity. It has already proved its value on a motoring tour and on a cruise, and also did duty at the Royal Naval Review, where the broadcast commentary was listened to and followed throughout "on the spot."

Events of the Week in Brief Review

Prison Radio

A NEW prison at Louvain, Belgium, will include a loud speaker in every cell connected to a central radio receiver.

Second-class Listening

TO placate impatient listeners in districts where reception of the Norwegian National programme is practically impossible, the Post Office authorities have instituted 2nd class licences, costing only 5 kroner, or a quarter of the usual amount, in localities where signal strength does not approach an agreed number of millivolts per metre.

Another 5-Metre Field Day

IN response to a large number of requests, the Golder's Green and Hendon Radio Society will hold another 5-metre field day on Sunday, September 15th. A warm welcome is extended to all *Wireless World* readers to take part. Full particulars can be obtained on sending a stamped addressed envelope to Lt.-Col. Ashley Scarlett, 8, Derehurst Gardens, Hendon, N.W.4.

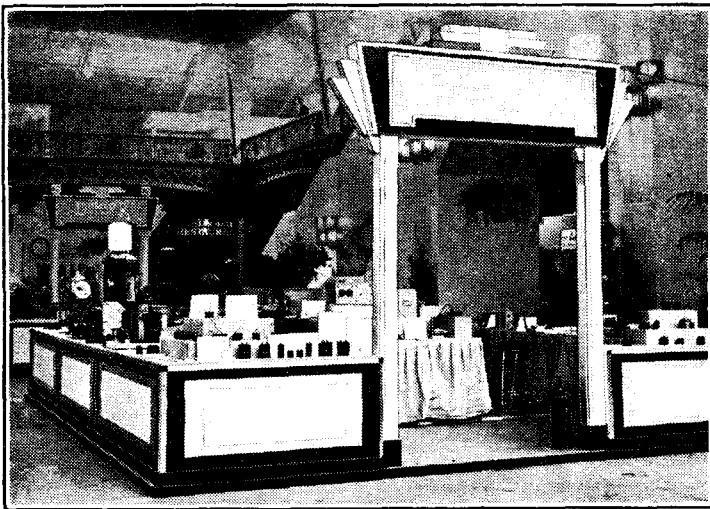

HELP FOR THE HARASSED. The Anti-Interference Bureau at Olympia, which is proving very helpful to listeners troubled with man-made static. The stand has been organised by the R.M.A. in conjunction with the Post Office, the Electrical Research Association, the B.B.C., and manufacturers of noise suppressors.

A New Language

JAPANESE radio officials have had to invent a new hybrid language for broadcasting purposes which is a nice compromise between the "masculine" and "feminine" vernacular. Up till quite recently men were forbidden to borrow women's expressions, and *vice versa*. Broadcasting, with its mixed audience, has broken down another barrier, and

"radio Japanese" bids fair to become the language of the people.

Sponsored Programmes in I.O.M.?

THE possibility of sponsored programmes from a British station is raised following the announcement that Mr. J. H. L. Cowin, a member of the Manx House of Keys, is pursuing the idea of establishing a broadcasting station in the Isle of Man. Its object would be to give publicity to the island, and the various entertainments would be drawn upon for programme building in the summer. In the winter, however, it would be necessary to seek the support of British advertisers.

Televisiophobia

WIDELY divergent views on the possibilities of television are held in Denmark and Sweden. Danish radio authorities, according to a correspondent, are betraying every symptom of that contagious disease, *televisiophobia*. No mention is made of television in Denmark's plans for radio development, and when the topic was men-

tioned in connection with the construction of a Radio House in Copenhagen, it was decided that television was too remote a project to be seriously considered.

Sweden, on the other hand, is evincing great interest in German developments. At a recent conference of dealers German apparatus was demonstrated and plans were discussed for making the public television-conscious.

Perturbators' Bad Time

SO active are the parasite chasers of the French Postmaster-General that 3,393 investigations into the causes of electrical interference with broadcast reception during July revealed 13,577 offenders. If every murder hunt was as mathematically successful the race of man-killers would soon be extinct.

People in France who are found responsible for man-made static are dubbed "perturbators."

The Late Viscount Bridgeman

THE death of Viscount Bridgeman, Chairman of the B.B.C., which occurred on Wednesday, August 14th, was referred to in a speech by the Rt. Hon. H. A. L. Fisher, a member of the B.B.C. Board of Governors, at a meeting of educational associations in Oxford. "I feel," he remarked, "that I should say a few words with reference to the great loss which the B.B.C. has sustained in the death of Lord Bridgeman. Although he had been our Chairman for only a few months, his name has for long been in the forefront of British politics, and, as a Governor and later as Chairman of the B.B.C., he was closely concerned with its affairs."

Television: P.M.G.'s Statement

THE Postmaster-General announced last week that, on the recommendation of the Television Advisory Committee, he had now authorised the British Broadcasting Corporation to make arrangements with the Baird Television Company, Limited, and the Marconi-E.M.I. Television Company, Limited, for the provision of complete transmitting equipment for the operation of their respective systems at the Alexandra Palace, and, subject to the settlement of certain outstanding points, orders would be placed accordingly.

The work of manufacture and installation is expected to be finished in approximately six months; and the first test transmissions should, therefore, start in the early part of next year, to be followed by a regular public service as soon as practicable thereafter. Constructional work at the Alexandra Palace has already begun.

Such technical information regarding the characteristics of the television signals radiated by the two systems as will

facilitate the designing of television receivers capable of picking up those signals will be published at an early date.

Assurances are being obtained from the companies concerned that licences will be granted to any responsible manufacturer to use their patents for the manufacture of television receiving sets in this country on payment of royalty on reasonable terms.



OLYMPIA'S SMALLEST? The "police" type of wireless set—a replica of that used by the Brighton constabulary—is now available to the ordinary man. This picture, taken at the Radio Exhibition, shows the Empiric pocket receiver in use. It weighs 6½ lb., including 75-volt HT battery.

Land Line Festival

A FESTIVAL broadcast will shortly be distributed throughout Norway to celebrate the completion of high-frequency cable laid by Standard Telephones and Cables, which will link up the whole country with the Oslo broadcasting studio.

The cable, which is stated to carry a range of frequencies from 30 to 8,000 cycles, extends from the capital to the northernmost station at Vadsø, 1,400 miles away.

"The Wireless World" Index and Binding Case

THE Index for Volume XXXVI, January to June, 1935, is now ready and may be obtained from the publisher: at Dorset House, Stamford Street, London, S.E.1, price 4d., post free, or with binding case, 3s. 1d., post free.

High Fidelity in the Home

The Electrical and Acoustical Requirements for Quality Reproduction

IMPROVEMENTS in the design of variable selectivity HF couplings have solved the electrical problems associated with high-fidelity receivers, but much work remains to be done in adapting loud speaker response to the acoustic conditions prevailing in the average living room

THE attainment of perfect reproduction is hardly within the bounds of possibility, but the human ear is sufficiently accommodating to permit us to obtain what we may term practical perfection—reproduction which is so close an approach to the original that it is hard to detect any difference. To attain even this degree of perfection, however, demands meticulous attention to detail throughout the whole of the transmitting and receiving equipment. Only the latter is under the immediate control of the listener, so that in this article we shall confine the discussion to the receiver and its associated reproducing apparatus.

The requirements for practical perfection in the whole receiving equipment are easily stated, and comprise:—

(1) An overall modulation frequency response curve flat within ± 3 db. between the limits of 30 c/s and 15,000 c/s.

(2) The permissible variations in response to be progressive at the limits of the band and not sudden peaks or troughs in the curve.

(3) Amplitude or harmonic distortion to be as small as possible.

(4) Power output from the receiver adequate for the volume level required. The determination of this involves the efficiency of the loud speaker and a knowledge of the room acoustics.

(5) Volume expansion to correct for the compression in the control room of the transmitter.

(6) Minimum phase distortion.

The attainment of all these objectives simultaneously is likely to prove a very expensive business, and it is fortunate that it is hardly necessary to aim so high at the present time, for the distortion introduced by the best loud speaker, particularly when the room acoustics are taken into consideration, is so great that the receiver itself can be appreciably below the ideal standard of practical perfection without a noticeable deterioration in the standard of reproduction. Thus, a response flat within 3 db. between 30 c/s and 15,000 c/s is unnecessarily good, and all practical requirements will be met if the frequency limits are set at 50 c/s and 10,000 c/s: phase distortion is not very important, and volume expansion is something of a luxury.

Even if we aim at only this lower standard, however, we shall find that it is obtainable only in local reception, for on other stations interference will not permit us to retain the full high-frequency re-

sponse. It is theoretically possible to reproduce up to 3,000 c/s only if interference is to be avoided with the present frequency separation of broadcasting stations. The position is relieved in prac-

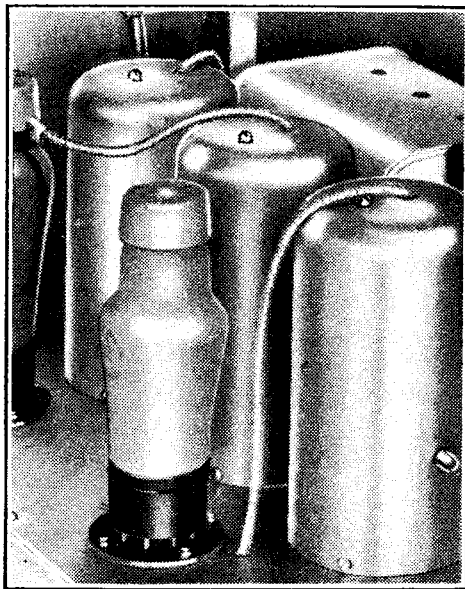

Variable-selectivity transformers in the 1936 Monodial AC Super.

tice, however, by the fact that adjacent transmissions are usually of widely differing strengths at the point of reception, and by confining our reception to the stronger stations we can extend the frequency response without introducing audible interference. Even so, the full response up to 10,000 c/s is normally useful only for local reception. This is only another way of saying that interference permits us to obtain any approach to perfect reproduction only from the local station.

Variable Selectivity or Tone-correction

It is clear, therefore, that any receiver intended for more than local reception should have a frequency characteristic which is variable at will by the operator. This is most economically achieved by variable selectivity, for it is the tuning circuits which are responsible for most of the failings of selective receivers in the matter of the high-frequency response. It is, of course, theoretically possible to employ fixed tuning circuits of high selectivity with tone-correction for the side-

band cutting and to achieve the variable response by altering the tone-corrector. Investigation shows, however, that this scheme is unlikely to prove as economical as true variable selectivity, which is now finding its way into receivers.¹

The superheterodyne or the single-span receiver is likely to prove better than the straight set for quality reception unless the latter includes permeability tuning, for with the ordinary straight HF amplifier the selectivity, and hence the degree of sideband cutting, varies considerably with the tuning. The detector does not now offer any special problems, for a correctly used diode detector is very nearly distortionless.

Advantages of Push-pull

The low-frequency circuits do not offer any particular problems except when very large output or extreme economy of power consumption is needed. Although serious distortion can be introduced in these circuits it is not difficult to avoid it, particularly when a resistance-coupled push-pull amplifier is used, for the design is straightforward and easy to reproduce. Push-pull amplification is very desirable when the highest quality is required, for amplitude distortion is greatly reduced, together with unwanted coupling effects caused by the impedance of the power supply system. The use of resistance-coupling is also desirable, for it is easier to secure a flat frequency characteristic, there is less chance of amplitude distortion, and phase distortion is likely to be smaller than with other systems.

Even the most perfect receiver, however, will give only mediocre results if it be associated with an unsuitable loud speaker or if the loud speaker be incorrectly used. The loud speaker is still the weakest link in the chain, in spite of recent improvements, and its choice demands careful consideration.

There are two schools of thought regarding the best method of obtaining a wide and uniform frequency response in the loud speaker system. In the one, two loud speaker units of identical design are used in order to provide a large radiating area for the lowest frequencies, and to reduce the loading of each unit so that a large acoustic output may be

¹ The 1936 Monodial AC Super. *The Wireless World*, July 26th and August 2nd, 1935.

High Fidelity in the Home—

obtained without amplitude distortion. It is, of course, difficult to produce single units of this type having a sufficiently wide frequency range, but recent research has resulted in the appearance of such loud speakers, which for all practical purposes are level from 50 to 8,000 or 9,000 cycles.

In the other a somewhat wider frequency range is aimed at, and two or even three units are used, one for the bass and the remainder for the middle and high frequencies, the different sections being carefully dovetailed to eliminate irregularities at the boundary frequencies.

Cabinet Design

Whichever method is adopted the closest attention must be paid to the design and construction of the cabinet. It may not be possible entirely to eliminate cavity resonances, but by building the cabinet of heavy and rigid material, troubles due to panel vibration can be easily overcome.

The position of the loud speakers in the cabinet is also important, and it is now customary to aim for an asymmetrical arrangement in order that the distances between the back and front of the diaphragm may vary between as wide limits as possible. When the loud speaker is placed symmetrical in the centre of the front panel one or more absorption points may occur in the response curve, but an asymmetrical arrangement distributes this effect over a wide portion of the frequency range.

Working along these lines it should be possible to produce a set which, in the open air, would give a practically flat response over the frequency range required. When the set is taken into a

found modifications of the previously ideal curve. Apart from reverberation and standing wave effects which produce rapid undulations in the sound pressure

listening. Indeed, the acoustic engineer might reasonably demand such a condition—after all, the room is part of the

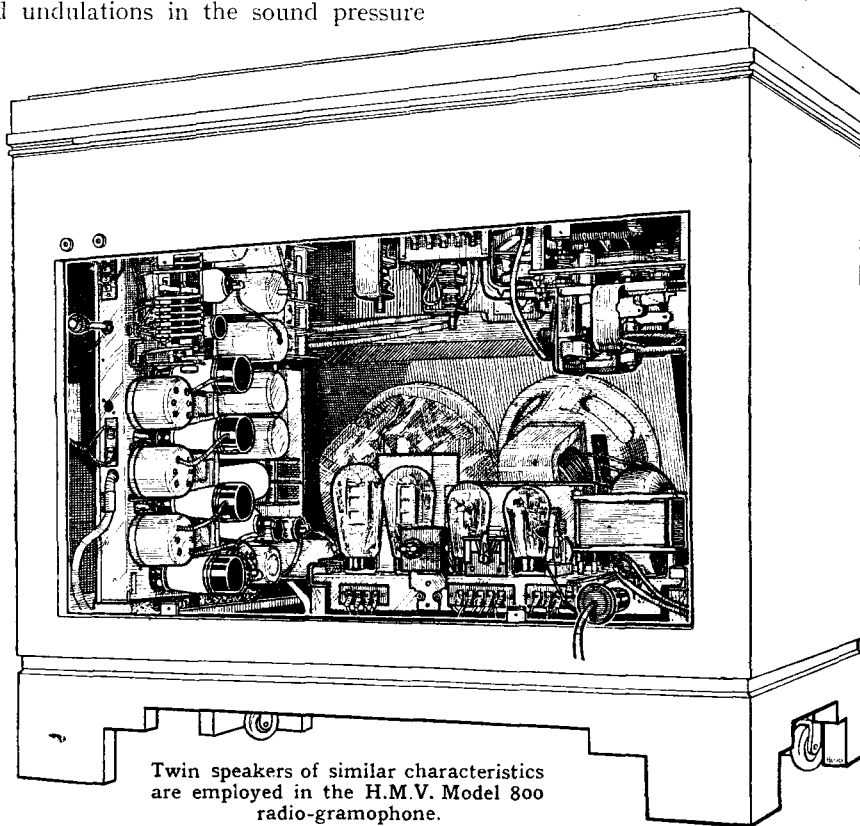

Twin speakers of similar characteristics are employed in the H.M.V. Model 800 radio-gramophone.

response at different parts of the room, the proximity of the walls to the back of the cabinet may also modify any cavity resonances which may be present.

Again, if the cabinet is placed in a corner of the room the adjacent walls may produce a horn effect which will result in an apparent increase in the bass response. Fortunately, in the middle and upper registers the binaural effect in hearing tends to smooth out any irregularities due to standing waves, but in the extreme low frequencies, where the wavelength is larger, pronounced irregularities in the response cannot be ignored.

While it is possible, by taking measurements in a number of typical living rooms, to ascertain the type of correction required, the exact point in the frequency scale and the amount of the correction cannot be predicted without an individual test in the actual room in which the set is to be used. It would seem, therefore, that there is a limit beyond which it is wasteful to go in producing high-fidelity sets for quantity production, and that if further improvement in the performance of domestic receivers is demanded the receiver will have to be acoustically "made to measure" for the particular room in which it is to be used. Not only so, but the customer will have to make important concessions in the good cause inasmuch as he will be called upon to decide on a definite position where he proposes to sit, and will only be guaranteed faithful reproduction provided that he always uses this spot.

The cost of such an equipment would naturally be very high, but might be lessened by setting aside a special room for

loud speaker system. The only alternatives would seem to be listening in the open air or reviving the question of quality headphone reception.

Below the Short Waves

THE kinship between ordinary wireless waves and those producing the sensation of light is usually regarded as a matter of more or less academic interest. In television, however, the connection between the two is brought home to the mind more forcibly, because here one both starts and ends with definite vibrations in the ether.

In addition, the frequencies required to produce and radiate high-definition pictures are beginning to approach the gap which has so long separated the art of practical wireless from the field of optics. For instance, we have already abandoned the medium broadcast wavelengths in favour of the pseudo-optical properties of the seven-metre wave, so far as television is concerned, whilst the so-called centimetre waves are still in reserve.

However, once we cross the other side of the border line we find that visible light is confined to a band of waves which, in frequency, covers less than a single octave, and in length varies from 4,000 to 7,500 Angstrom units. It is convenient to remember that an Angstrom equals 10^{-10} of a metre, and is sometimes called a tenth-metre.

The yellow "sodium" flame, which lies at about the middle of the visible band, is a little less than 6,000 Angstroms or 0.0006 of a millimetre in length, and has a frequency of approximately 500 million million cycles a second. Which goes to show, after all, that there is still a long stretch of no-man's land between "visible" and wireless radiation.

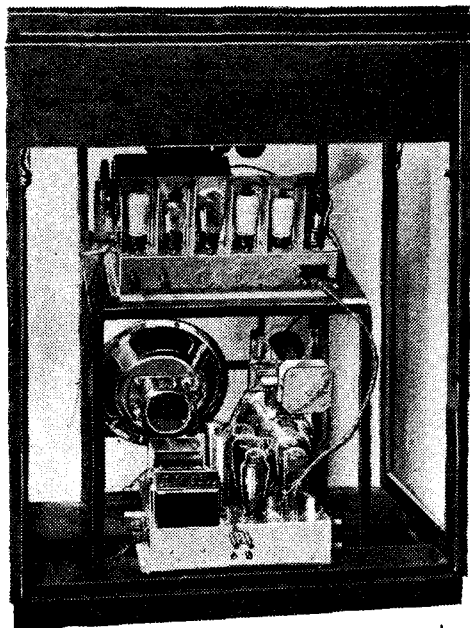

Demonstration Model 1203 R.G.D. radio-gramophone in glass case, showing triple loud speaker units.

room, however, the walls and the enclosed airspace virtually become part of the loud speaker system and may introduce pro-

The New Season's Components

Interesting Features in Their Design

THE general impression left by a close study of this season's new components is that electrically and mechanically they are definitely better than in the past. So far as this applies to workmanship it is not that more attention is given to attractive finish, but that manufacturing processes have so improved that articles obviously not touched

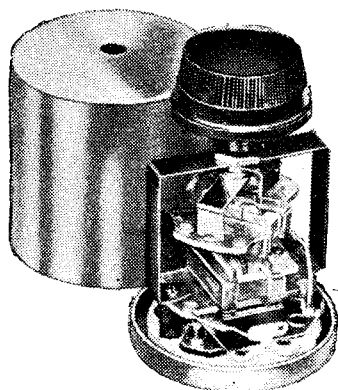

Colvern variable selectivity 465 kc/s IF transformer.

up by hand to appeal to the eye exhibit that good, sound workmanship that one used to associate only with high-grade, expensive products.

There are still many outstanding examples of well-finished components; well-finished now applied in the sense that they are above the average, despite the fact that the average standard is in itself high-grade compared with the products of a few years ago. Yet prices are, in the main, most reasonable.

It is apparently anticipated that higher intermediate frequencies than 110 kc/s will be employed in the new season's superheterodynes, especially those de-

Wearite Uni-Gen coil, an air-cored general-purpose model.

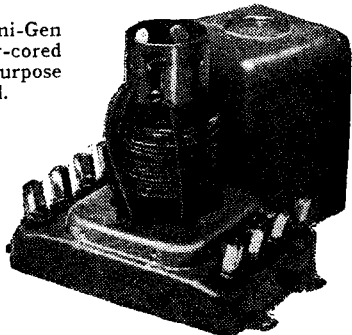

signed for all-wave reception. Practically all the well-known coil makers have models for 465 kc/s, or of that order,

whilst quite a new development is the variable-selectivity type, the majority of which are designed for the higher frequency.

Control over the band-width of the IF amplifier has been provided for in the past, but the adjustment has, so far, been of a pre-set nature, that is to say, it had to be fixed during the initial adjustment of the set. Subsequent alterations could be made only at considerable difficulty, since each transformer had to be adjusted individually.

With the new components the response of the amplifier can be adjusted from the control panel, thereby permitting the best compromise between quality of reproduction and interference from adjacent channels to be found for every individual station in the broadcast band.

There are several ways of achieving this in practice, but with one exception all the new designs embody mechanism for varying the coupling between the primary and the secondary circuits, and in every case provision is made for linking up the spindles to a single panel control so that

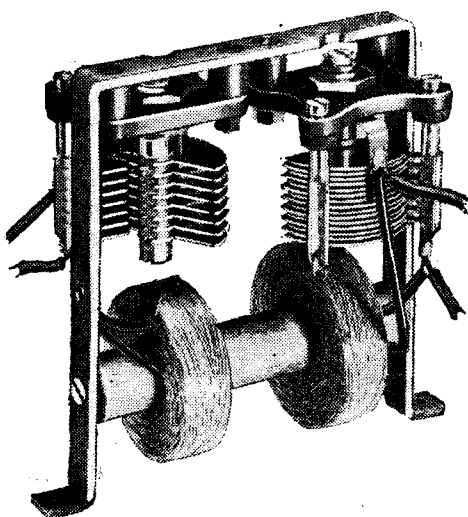

Litz-wound coils and air-spaced trimmers are used in the Eddystone 400/500 kc/s IF transformer.

the response of all the IF transformers in the set is adjusted simultaneously.

In the Sound Sales and Wearite models a cradle with a double-ended spindle carries the movable coil so that these would be assembled in line and at right angles to the panel to bring the control to the front. The Varley Variband IF unit has a single-ended spindle, and for the ganged assemblies the spindles are inter-

connected by a system of cranks and levers. The ganged unit is then mounted with the coils parallel to the panel on which the control is located.

Variable coupling is employed, also, in the Colvern model, only in this case the two coils are mounted one above the other, and the upper coil is rotated by a knob on top of the screening can. It is under-

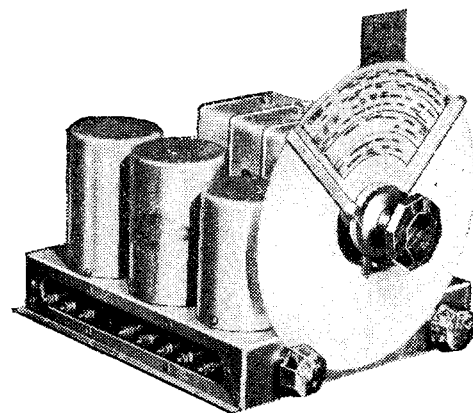

C.A.C. Superpak fitted with the new Scanning Disc tuning dial.

stood that a coupling for ganging the controls will soon be available.

The Bulgin variable selectivity IF transformer operates on an entirely different principle. It has fixed primary and secondary coils, the coupling being arranged to give a 5 kc/s band width. Broadening of the transformer response is then effected by means of a 5,000-ohm variable resistance, which is connected across a tertiary winding located midway between the primary and secondary coils. It is claimed that the variation obtainable is from 5 to 10 kc/s. A separate resist-

Formo Snail dial embodying a two-ratio drive and a 270-degree scale.

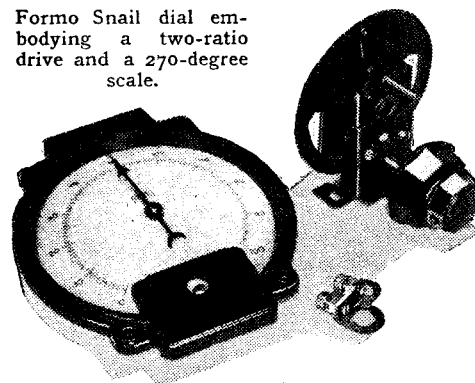

ance is needed, of course, for each IF transformer, but there is no reason why

The New Season's Components—

they should not be ganged for single-knob control.

There are, also, several new IF transformers designed for the higher frequency but with a fixed or semi-variable coupling. Most coil makers are agreed that a change

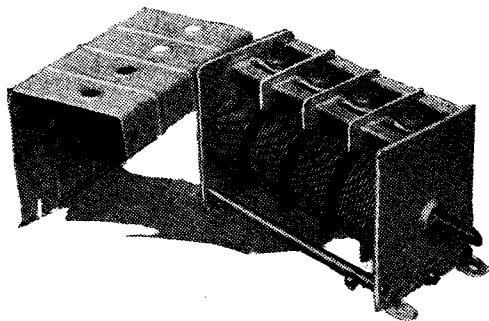

Polar four-gang Midget condenser.

in the frequency of the intermediate amplifier in the new season's superheterodynes will be needed if provision for short-wave reception is to be made and effected in a satisfactory manner. Individual ideas differ, however, as to what this frequency shall be; some, such as Colvern, Sound Sales, Wearite, and Varley favour 465 kc/s, but Bulgin and Stratton are designing their models for 450 kc/s.

Far more attention to detail is necessary in the design of IF units for the higher frequency than for 110 kc/s in order to obtain the same degree of selectivity.

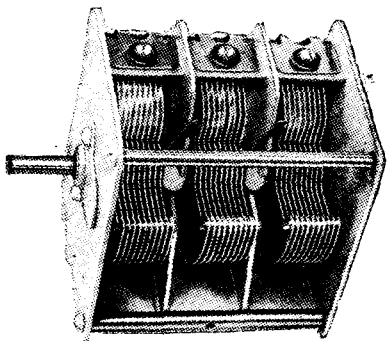

One of the new J.B. Baby-gang condensers.

Litz-wound coils, some of which are sectionalised, are largely used, while in the Stratton and Varley models air-dielectric trimmers are included also.

Any change in the intermediate frequency must be accompanied by a modification to the oscillator coils, and to the gang condenser if an oscillator tracking section is required, though the latter can be dispensed with by suitably padding the circuit with series and parallel condensers.

It is, therefore, quite in keeping with one's expectations to find several new coil assemblies and tuning units for use with the higher intermediate frequency amplifiers, though the majority are still of the two-wave band type covering the medium—and long—waves only.

There is an interesting all-wave coil unit in the Bulgin range, which consists of two coil formers separately screened, and each former carries coils for two wave bands, 15 to 85 metres on the short waves, 200 to 500 metres medium- and 1,000 to 2,000 metres long-waves. It requires an external wave-change switch, but a new Bulgin model is available for it. Aerial and oscillator coil assemblies cost 17s. 6d., and the special four-pole five-way switch 8s.

Apart from minor improvements, few changes in the design of tuning coils are noticed. Iron-cored models predominate, though a wide selection of the air-cored type, augmented in some cases by new or re-designed coils, is still available.

A series of skeletonised coils, costing from 4s. to 4s. 9d. each, is shown by Bulgin; Wearite has several models, among which is the "Uni-Gen" coil, a general-purpose coil costing 5s., and

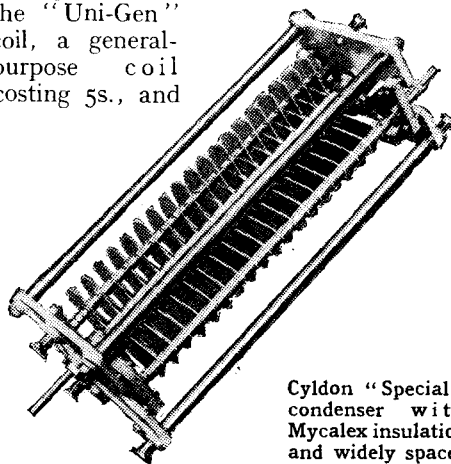

Cyldon "Special" condenser with Mycalex insulation and widely spaced vanes.

which is an improved version of their Universal model of last season.

Colvern air-cored coils remain ostensibly the same, but some additions have been made to their Ferrocart series, the coil units consisting of two or more coils on a small chassis and embodying waveband switching, supplemented by a gramophone or a mains switch, having been extended to include some fitted with oscillator coils for the latest types of frequency-changers also for use with 465 kc/s IF amplifiers.

Selection of Bulgin ultra-short-wave components including a super-regenerative quenching coil.

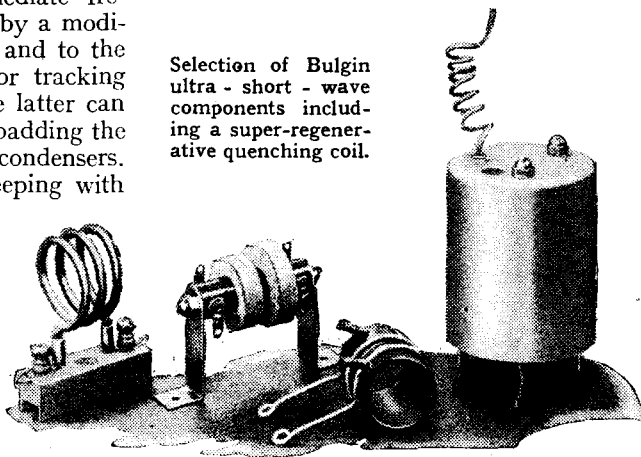

Iron-cored coils are to be found, also, on the stands of Varley and Formo.

The composite tuning unit, or pack, consisting of coils, gang condenser, switches, and sometimes a volume control, which was introduced a year or two ago, still retains its popularity. They are shown by Colvern, J.B., and C.A.C., the

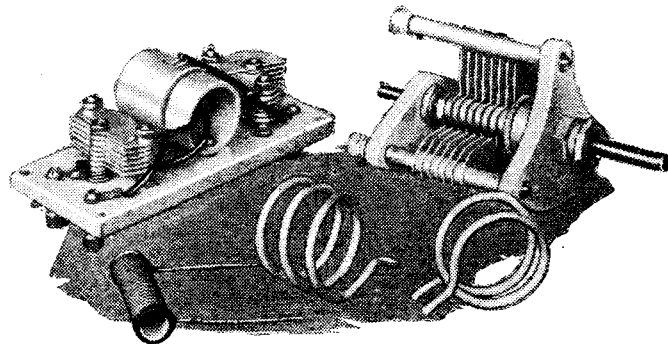

B.T.S. ultra-short-wave coils, condenser and IF unit.

last-mentioned firm now fitting their Superpak with the new "Scanning Disc" tuning dial and coils for a triode-pentode frequency-changer. In this form it costs 65s. complete.

Although not a "pack" in the sense applied here, the Varley Permeability Tuner might justifiably be included in this section, for it is a complete tuning unit. The whole idea of these units is to relieve the set builder of certain constructional work, while in some models the circuits are matched so that final adjustments only are needed. The Varley tuner also fits this description.

There is now a four-gang model available, and all the necessary padding coils are enclosed in the oscillator section of the superhet types. Thus there is one stage less in the initial adjustment, since accurate tracking of the circuits is ensured.

Several new pattern condenser drives have appeared this year, for, in addition

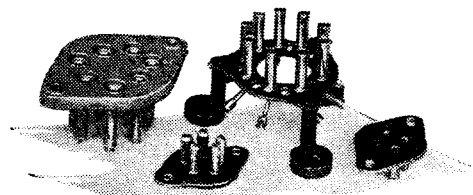

Clix valveholders for short-wave use and for the Hivac pin-type Midget valves.

to the C.A.C. model mentioned, J.B. has an airplane type, and Formo one in which the pointer travels over 270 degrees of the scale.

It was hardly to be expected that any marked changes would be seen this year in the design of gang condensers for ordinary broadcast sets in view of the high standard they have now attained. Some detailed improvements, however, have been effected. All the Polar Midget models have a one-piece steel chassis, which is claimed to be stronger and more rigid than the earlier type of frame. This series has been extended to include a four-gang model which costs 22s., the price of the three-gang remaining at 16s. 6d. This applies to both straight and superhet types.

J.B. has a redesigned Baby-gang range

The New Season's Components—

in which models with oscillator sections for 110 kc/s, 465 kc/s, and also 473 kc/s IF amplifiers are available. The three-gang type costs 15s., but an extra 1s. is charged for the 473 kc/s type. Gang condensers are made also by Ormond and Formo.

Exceptionally well-made precision condensers for use in high-grade test ap-

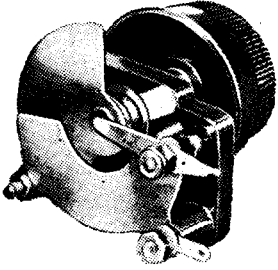

Colvern small variable condenser.

paratus, also a range of transmitting types, is to be seen on the Cyldon stand.

All who visit the Exhibition cannot fail to notice the more general interest shown this year in short-wave listening. Apart from the fact that many of the new season's sets, as described elsewhere, embody short-wave ranges, the exhibits of the leading component makers alone provide ample evidence.

That the need for special attention in the design and in the choice of materials for modern short-wave components is fully realised by all manufacturers is well exemplified by a detailed examination of the new season's models.

Stratton's stand is, as usual, almost exclusively a short-wave and ultra-short-wave exhibit with special attention given to the requirements of overseas listeners.

Amateur needs are well catered for by this firm, for the Eddystone range of components includes several designed for experimental transmitters, both of the short-

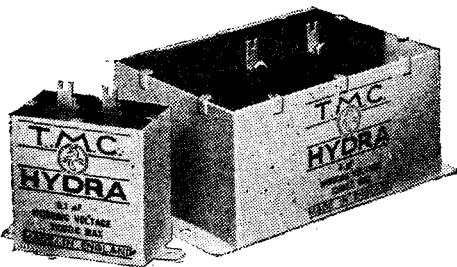

T.M.C.-Hydra condensers for use in high-voltage circuits.

and ultra-short-wave type; among the latest additions is a 2,000 mc/s IF unit for incorporating in 5- to 8-metre superheterodynes; it is a very compact unit, for it is assembled in a die-cast box measuring 6¼ in. × 2¼ in. × 1¼ in. only, yet there are three separately screened intervalve couplings for a two-stage IF amplifier.

Television is, of course, largely responsible for the present interest in these very high frequencies, for we find many new components in the Bulgin range designed especially for experimental work in this

sphere. This firm has a series of 5- to 8-metre coils, a 15 mc/s IF unit, and many other parts for ultra-short-wave sets.

B.T.S. is another firm very active in this field; coils, variable condensers, air-spaced fixed capacities of low value, together with a 12-mc/s IF unit make a very imposing display. The coils and the condenser vanes are all heavily silver-plated. Incidentally, both Eddystone and Bulgin silver-plate their ultra-short-wave coils. This practice is adopted as these very high-frequency currents are confined mainly to the surface of the conductor, and a coating of silver reduces considerably the HF resistance of the coil. Wire of large diameter is employed not only to render them rigid and self-supporting, for the dielectric losses in coil formers even of the best commercial materials are serious at these frequencies, but it provides also a large surface area.

Several firms apart from those already mentioned have short-wave parts, Polar some variable condensers, one new model having zinc-alloy vanes, as it has been found that condenser microphony is very prevalent at the high frequencies if the

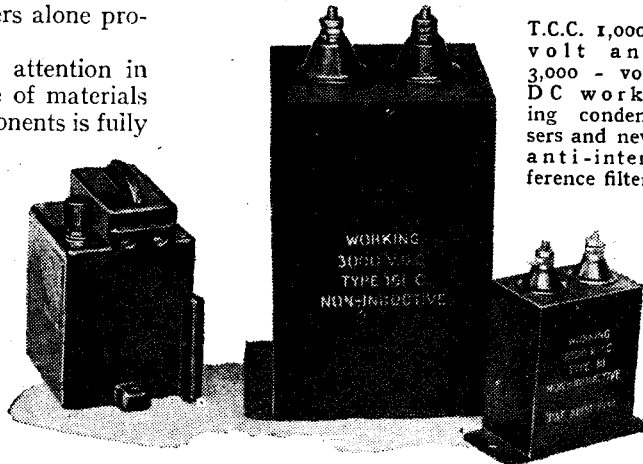

T.C.C. 1,000-volt and 3,000-volt DC working condensers and new anti-interference filter.

vanes are too springy. Cyldon and J.B. have some fine examples, while Colvern has a small variable condenser consisting of one moving and one fixed vane.

Special low-loss base-board-type valveholders in which the minimum of insulating material is employed can be seen on the Clix stand, and this firm has also the chassis style assembled on a plate of ceramic material.

Short-wave converters are, as usual, well in evidence, there being models shown by J. J. Eastick, R.I., Union Radio, B.T.S., who have an ultra-short-wave model, and Stratton.

Investigation into the causes of electrical interference and the development of devices for ameliorating this evil has now reached a stage where once the source is found it can be dealt with in a most satisfactory manner. Unfortunately, it is not always possible to apply remedial measures to the offending apparatus, but much can be done to minimise the effects in the listener's own home. Belling and Lee has, perhaps, the most comprehensive display of interference suppressors, though several other firms are showing condenser units, notably Bulgin, T.C.C., and

Dubilier, whilst Sound Sales has some inductors for inserting in the supply mains of motors and other electrical appliances.

Unless there is a valid reason for modifying a component, there seems no point in changing its design merely for the sake

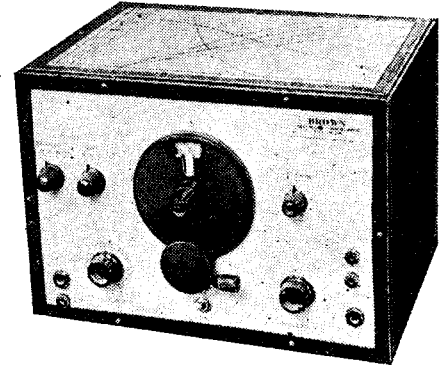

Brown All-wave modulated oscillator Type M2S.

of change, while the said part or parts continue to meet all current demands.

Stabilisation, where practical, provided it does not jeopardise future development, is a sound policy, and its virtues should be realised. It would be possible to enumerate several examples of this, but for the present suffice it to say that it applies in full measure to small condensers and resistances, which in a modern set are often found by the score. These remain ostensibly as hitherto, though Erie has introduced one new type in which the resistance element is totally enclosed in an insulated sleeve.

Occasion has arisen, however, for some new high-voltage types, which will find application in large power amplifiers,

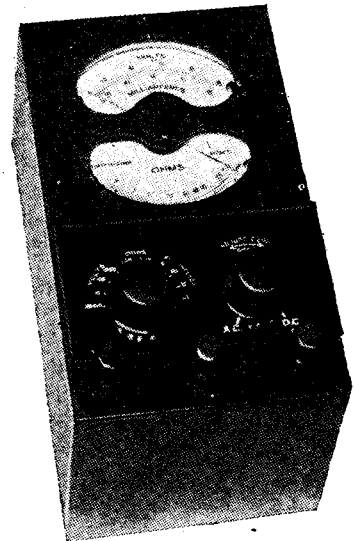

Radiolab All-Purpose Tester.

cathode-ray tube work, and the like. One might bracket with this television apparatus in so far as it applies to the cathode-ray tube equipment.

These condensers are in some cases for working potentials as high as 4,000 volts DC, and they can be obtained in sizes up to 10 mfd. They are shown by Dubilier, which firm has a series of oil-immersed paper dielectric condensers in hermetically sealed metal cases, and by T.C.C. The last-mentioned make employ petroleum jelly

The New Season's Components—

in place of free oil, the normal range containing models for working potentials of from 1,000 volts DC to 2,500 volts DC. T.M.C.-Hydra make fixed paper-dielectric condensers in all capacities and up to 1,500 volts DC working.

The very fine display of test apparatus seen this year, though mainly of interest to service engineers and test-room workers, is very impressive in that it is a silent reminder that the trial and error methods of test are but a relic of the past. Technical ability and soundly and scientifically designed equipment are essential adjuncts to the servicing of modern receivers, and of the latter there is a wide

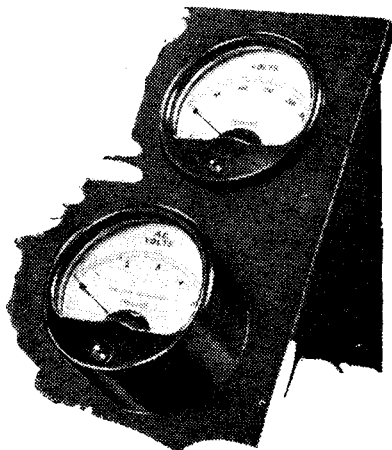

New Ferranti 2-in. meters, showing projecting and flush fitting models.

choice. All types of test apparatus, such as signal generators, modulated oscillators, valve test panels, and the like, are shown by the Automatic Coil Winder Co., Brown Radio, Everett Edgcombe, Ferranti, Weston, and Wearite, while smaller sets, such as universal measuring instruments and single meters that best meet the needs of the listener and also the amateur experimenter are included in the products of these firms, as well as in those of Bulgin and Haynes Radio.

An interesting development this year is the inclusion of the short-waves in the test oscillators, while Brown Radio has a model covering the ultra-short-wave band as well.

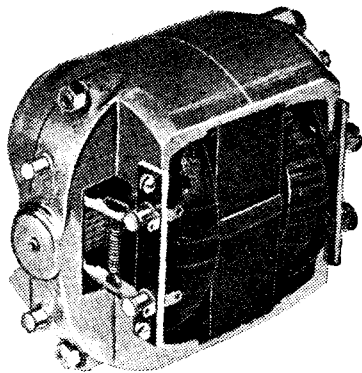

Redesigned Electro Dynamic car radio 12-watt HT rotary transformer.

Among the accessories is a long range of small rotary machines made by the Electro Dynamic Co. They include converters for operating AC sets from DC mains, or from LT batteries, petrol-driven

alternators, mainly for portable public address use, and small rotary transformers for obtaining HT from LT batteries, a typical example of the latter being the new 12-watt car radio unit.

All but the petrol-driven machines are available assembled in sound-proof cabinets, including specially designed filters.

An AC to DC converter for use where the supply has been changed from the latter to the former and a DC set was employed hitherto is manufactured by Sound Sales. This is a valve-rectifier unit giving 300 mA at 220 volts smoothed DC and costs £4 2s. 6d. It is possible to obtain larger models if required.

That no fewer than fifteen firms are interested in the manufacture of batteries offers ample proof of the popularity of the battery set. The real improvements in construction are chemical rather than physical, though physical differences do exist, but size and shape are merely incidental, and it is in the cells that one looks for the progress. Longer life and the maintenance at a reasonably high level of the voltage under its normal operating load, constitute the principal features of the new season's products. This applies likewise to LT batteries, the construction of the plates, and the methods adopted to ensure secure retention of the paste are the matters that really count. New types



(Left) Ardente moving-coil microphone.

(Below) Sonochorde, hand-type Piezo-electric microphone, Model D104.

of acid traps for portable batteries have been evolved, so that, on the whole, this year the user is obtaining better value than ever.

Most makers now fit charge indicators in one form or another in the LT cells, the latest addition being the Capacity Clock seen in the Oldham range. Exide have, of course, had an indicator in their cells for some time, and the novel device introduced last season is retained this year.

Batteries are shown this year by Burndey, C.A.V., Ever Ready, Exide and Drydex, Fuller, G.E.C., Hellesens, Milnes, Oldham, Pertrix, Peto and Radford, Primus, Siemens, and Vidor.

As an alternative to the wet- and dry-type batteries there is the mains unit designed to operate either from AC or from DC mains, the AC units, as a rule, including an LT trickle charger. Examples of

these are the Atlas, Burton, Ekco, Heayberd and Regentone models, while Heayberd have also a series of LT battery chargers, and Westinghouse are represented in this class by metal rectifiers both of the LT and HT variety.

A few years ago it was impossible to find a good microphone in the Exhibition at a reasonable price. Sound-reproducing equipment, perhaps better known as public-address apparatus, has developed rapidly in the past year or so, and now quite a wide choice of high-grade but comparatively inexpensive microphones are available. The three principal varieties seen this year are: transverse current car-

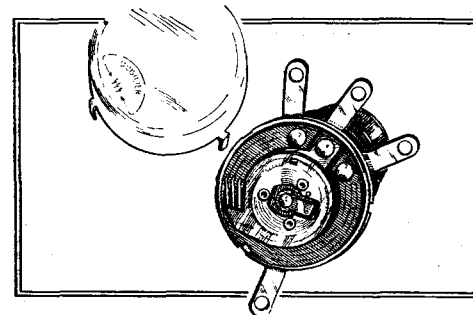

Dubilier "Fadover" volume control operates on radio and gramophone without the aid of a change-over switch.

bon, moving-coil, and Rochelle-salt crystal types respectively. The T.M.C. Varidep and the Ossicaide series fall within the first-mentioned category, being available at prices ranging from £4 10s. to about £10 10s. for standard PA types. Ardente has some carbon models also, as well as a new moving-coil type, while Film Industries and Gramplan are also showing models of this pattern, the prices being from about £4 10s. to £12 12s. The Rochelle Salt crystal, or Piezo-electric types, as they are known, are included in the products of Sonochorde, and there are many different styles. One pattern, the D104, is a hand model with a switch key embodied in the handle; it costs £6 6s. These are all genuine high-grade microphones designed for band repeating, relaying speeches, and for all public address work in and out of doors.

Those small, yet nevertheless important, items that find place in our receivers and amplifiers are far too numerous for detailed mention here. Bulgin has an enor-

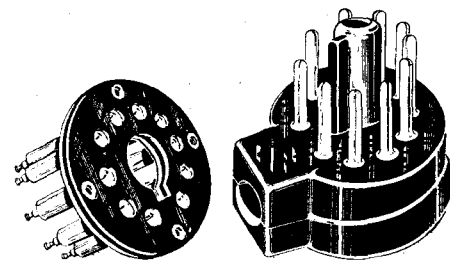

One of the new Belling-Lee components, a safety-type 10-pin cable plug and socket.

mous variety, while the Clix specialties include connectors of every conceivable kind. Products of a like nature are made by Belling and Lee, which firm has quite a number of new and interesting items.

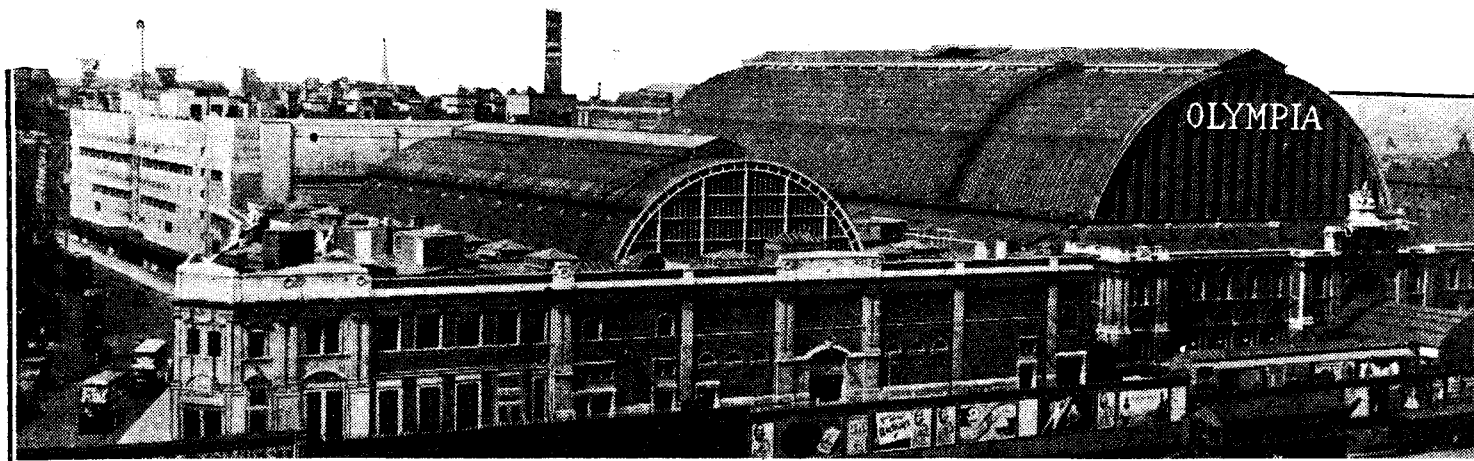

Radiolympia 1935. By a Critic of Quality

PERHAPS because I have had too much radio in the hot weather; perhaps because I have not long returned from one of the best holidays I have ever had in the great open spaces; perhaps simply because I may be feeling dyspeptic, which I think is not the case, I have to announce a feeling of disappointment that I did not see more signs of what I wanted to see at this year's exhibition. Old readers of *The Wireless World* will remember that I take it upon myself annually to heave selected half-bricks at the poor unoffending manufacturers who do the best they can to provide the public with what the manufacturers think the public thinks it wants, and, anyway, it is easy to say that another man's efforts are a wash-out.

Why I Write

Seriously, however, the Editor asks me to describe each year those items at Olympia which, in my opinion, tend to develop the artistic appreciation of broadcasting in the mind of the listener, and I do try hard to be impartial. I remember that several correspondents last year tried to tell me where I step off, but they must remember that the only axe I have to grind is this: I like music, plays, talks, and even hot jazz. I am in possession of a wireless set which reproduces these with very little distortion, and I enjoy listening to my set. I do not enjoy listening to my friends' sets, and I can only conclude that my friends' sets distort so much more than mine that they remove the pleasure I derive from listening.

And, let me tell you, *I am not accustomed to the sound of my set*, for I spend more money than I ought in going to concerts, and I know what the real thing sounds like. I do find, however, that, when the B.B.C. is really in form, I thoroughly enjoy listening to a symphony concert at home, and I am fussy.

Once upon a time "wireless" was a scientific toy of a most marvellous nature, and I must confess to a real thrill when I got my first Californian station somewhere round about half-past three in a morning some fourteen years ago on a set which

was unspeakably loathesome in every respect other than getting stations. Even a nit-wit would have abstained from calling that set an emitter of musical sounds, but the tradition persists. The manufacturers say that they cannot sell a set which won't get foreign stations, and I want to know why. All the people I have ever met seem to listen to their local station in the evening, except when they go to the pictures, although I have met dreadful persons who listen to Luxemburg and places like that. With shame I confess that Luxemburg has been tuned in on my set on one occasion, but I found I was not consumed with the desire to go school-girl all over, so I switched off.

Now, if people buy sets to listen to their local station, would they bother to ask how many stations their proposed new set would get if manufacturers had the sense to refrain from claiming to get most of the civilised world, and not a little of the uncivilised? The public doesn't know much about the technique of receiver design, so they argue that a set which will get fifty stations is a better set than one which will get only forty, in much the same way that they think a car which will do sixty is a much better car than one which will only do fifty. The automobile industry has wakened up to the fact that an all-out speed which nobody uses when they might be simply adding to the cost and sacrificing more valuable features, such as flexibility, comfort, and so on. Some day, perhaps, the radio industry will drop the scales from its eyes, and turn out sets which will, inherently, be nice to listen to.

If it were not so pitiful, one might derive endless amusement from studying the efforts of designers to find a new variety of tuning scale or tuning indicator; of sales departments to describe, in ravishing terms, the striking beauty of a commonplace cabinet. The best tuning scale of all consists of two switches, one for the national programme and one for the regional; such a device renders unnecessary the use of fancy devices to tell whether you are "in tune" or not. Unfortunately, it is stated that there is no demand for such a set, which is rather

curious, for I believe that there are thousands of subscribers to relay services, and they have a choice of only two stations.

I will say that the average radio receiver sounds better than it did some years ago, but a visit to Olympia produces no evidence that there has been any improvement since last year because one must wait until one hears the sets working off their own bat. This business of common feed to the loud speakers is typical of the attitude adopted by officialdom. It doesn't matter what sort of sounds are made, because it is not the function of a wireless set to make any particular sort of sound. The idea is to start some new stunt and boost it in the daily Press throughout the land. The manufacturer with the most money probably sells the most sets, and the spoonfed public buys that set because it gets the most stations.

Some day we may get a rational radio exhibition. I have visions of seeing rows of sound-proof rooms outside of which the manufacturer displays his wares. I walk along the row and reject those sets which look nasty. Of the balance, I go into room after room and listen to the same programme on each, but the sets are working from their own aerials, and there must be a guarantee of "no faking." I then order the set whose reproduction appeals to me, and I am happy. I have been saved the labour of visiting a round dozen dealers' shops and manufacturers' demonstration rooms, and I have got the set I want. And, I do not want any side shows in my ideal exhibition.

Not all High-fidelity

Returning to Olympia, there are some manufacturers who specialise in "high-fidelity reproduction." In some cases they are frauds; some don't know what high-fidelity means when they hear it. There are, however, a few earnest firms who do a good job of work and who tackle the subject with respect and devotion. It isn't for me to tell you who they are. If you don't find them, then you are not keen enough on good results and will not be prepared to take the necessary trouble.

UNBIASED

By FREE GRID

Balloons

BEING a keen short-wave listener it naturally follows that I am a skilled morse listener and thus have advantages in being enabled to listen to things which are denied to many other short-wave listeners who have not bothered to learn the code.

For some weeks I have been intrigued by the exchange of messages between a certain amateur transmitter in this country and a fellow brass-pounder in Eastern Europe. Quite by chance I overheard a message which considerably whetted my curiosity, and further listening interested me still more as I couldn't make out what on earth they were talking, or rather morsing, about, and nothing worries me more than to listen to other people's conversation without learning its purport.

This case was no exception; mysterious references to balloons led me to believe that I was hot on the track of foreign spies, bent on unearthing the secret of our national defences, and all my war-time fervour was aroused. Soon, however, it was revealed that I was on the track of something far more serious.

As many people know, there are held at various seaside resorts at this time of the year what are known as balloon races.



Nothing worries me more.

These are staged either by well-known business houses for the perfectly legitimate purpose of advertisement, or by some local charitable organisation. A stall is set up from which intending competitors purchase for a few pence a small gas-filled balloon to which a label is attached bearing the name and address of the firm or hospital running the show, and a request to anybody finding the balloon and its label to drop it in the post.

The balloons are released and, being gas-filled, rapidly rise and are carried away. In many cases they travel hundreds of miles; several times some of them have reached one of the nearer European countries. Eventually they all

come to earth owing to exhaustion or other causes, and some of them are duly found and posted. The balloon which is returned from the greatest distance wins for its purchaser a prize of two or three guineas.

One would think that in an innocuous competition of this type there existed little opportunity for graft, but I regret that as the result of my investigations I have to report otherwise.

The "balloons" which I heard discussed were not important units of our aerial defence but were of the seaside competition variety, and the "plot" was one to make the prize a cast-iron certainty for the competitors. The idea was that amateur No. 1 should purchase and deflate a balloon, put it in an envelope together with its label, and post it to amateur No. 2 in Eastern Europe, who would promptly post it back to the address on the label. I need hardly insult the intelligence of my readers by pointing out the obvious result of this plot since, of course, Eastern Europe is sufficiently far from this country to make it unlikely for any genuine competitor to beat the distance. So far as I could gather, this state of affairs has existed for some considerable time. What line of action ought I to take in the matter?

Ploughing Mystery

SOMETIMES quite fortuitous happenings will bring to light things for which famous researchers have sought vainly for years.

As my agricultural friends will know, a reason has long been sought for the observed fact that land dealt with by a motor plough yields far more abundantly than that treated by the old-fashioned horse-drawn arrangement. The only explanation advanced has been that the motor plough turned over the land more quickly than the old horse-drawn type.

The foolishness of this explanation was revealed, however, when it was pointed out that a steam-driven plough turned over the land just as fast as a motor-driven one, and yet was far behind in the matter of fertilising the land.

It has remained for wireless, as usual, to bring to light the true explanation, but, it must be confessed, this explanation has turned up purely by chance. As most of you know, feverish activities have been going on lately in the development of high-definition television in readiness for next year, and some observant person noticed the astonishingly profuse growth of vegetation in the neighbourhood of the

buildings housing the experimental transmitters. This was so marked that the television experimenters were faced with a big bill for the cutting of the grass, which they had allowed to grow almost under their feet.

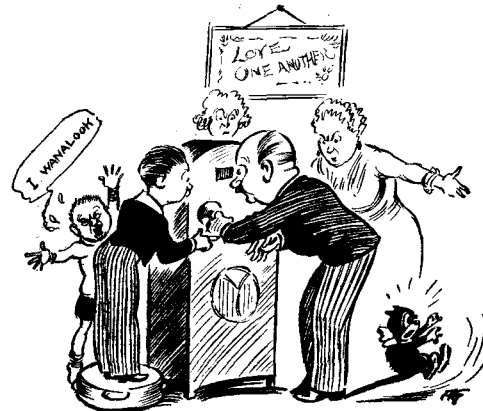

Feverish activities in Television.

The tin hat was put on the whole affair when thick vegetation was found to be sprouting from the ears of the various small boys in the neighbourhood, and their fathers referred the matter to the Board of Agriculture and Fisheries.

The result was that an expert was sent down who, upon investigation, recommended the application of soap and water, but a loud outcry was made by the intended victims against this proposed forcible application of a cruel and drastic remedy. Complaints were made to the N.S.P.C.C., and in the end the boys were relieved.

A budding Einstein, in the form of a charwoman employed in the buildings housing the television gear, finally revealed the true explanation, which can be summed up in three words, namely, ultra-short waves, which have been found to have a strong fertilising action on soil, and so at one fell swoop the whole mystery was solved.

The mystery of the motor plough still remained, however, but the fertilising effect has since been found to be due to the radiation of ultra-short waves by the ignition system of the engine, as the application of suitable suppressors has removed the effect. Needless to say, a company is being floated to capitalise this discovery, and as a first charge on it, it is proposed to endow a society for the protection of small boys from needless and wanton cruelty as a small token of gratitude, since it is felt that but for their valiant stand in defence of their rights this epoch-making discovery might never have been made.

Outstanding Broadcasts at Home and Abroad

THE LAST OF OLYMPIA

"PARTING is such sweet sorrow," as Juliet reminded Romeo, so, although to-morrow is the last night of Radiolympia, listeners should be able to extract much poignant pleasure from the final broadcast from the Exhibition theatre at 9 p.m. (Regional).

From the listener's point of view, these shows are "coming over" even more successfully than the St. George's Hall broadcasts. The audience is less restrained, possibly because they have paid for their seats and are out for a good time, but the microphones are well placed, and the amount of audience reaction audible at the receiver is just enough to convey the spirit of a jolly gathering.

If you really cannot visit Olympia on this night of nights tune in and make the best of a good job.

ONE-MAN NIGHTS AT THE "PROMS."

Is there too much specialisation in the Promenade Concerts? Each night next week except Saturday caters for one class of music lover only. In addition to the usual Wagner concert on Monday, and the Bach and Beethoven programmes on Wednesday and Friday respectively, we have a Russian evening on Tuesday and a Schubert concert on Thursday.

The Schubert programme is notable for the first appearance at a Promenade Concert of Elisabeth Schumann, the world-famous soprano, who,

30-LINE TELEVISION

Baird Process Transmissions.
Vision 261.1 m.; Sound, 296.6 m.

MONDAY, AUGUST 26th.
11.15—12.0 p.m.

Ray and Geoffrey Espinosa (in Grace, Rhythm and Speed); Louise Maxim (juggling); Ben Osborne and Nellie Perryer (in Cockney dramatic cameos); Sydney Jerome at the pianoforte.

WEDNESDAY, AUGUST 28th.
11—11.45 p.m.

Marion Wilson (dances); Doris Hare (songs); Jack Hodges (in song, story and sound); Billy Hoid (accordion solos); John Hendrik (songs); Sydney Jerome at the pianoforte.

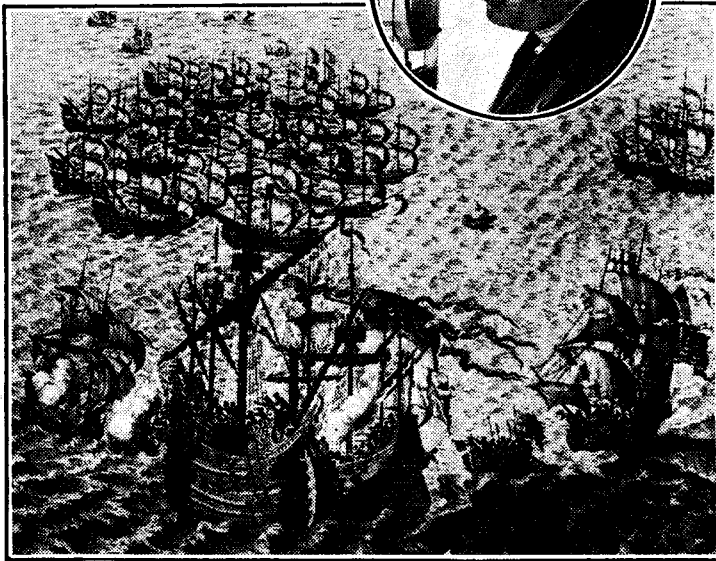

A RUNNING COMMENTARY ON THE SPANISH ARMADA is being attempted by the B.B.C. Drama Department on Tuesday and Wednesday next, when Whitaker Wilson's "Armada" will be presented. It narrates the story of the great campaign in hour-to-hour bulletins. Howard Rose is the producer.

incidentally, also appears in a studio recital at 7.15 p.m. on Sunday evening next (National).

In the Russian concert on Tuesday Antonio Brosa plays Stravinsky's Violin Concerto in D, and there are works by Tchaikowsky, Rimsky-Korsakov and Moussorgsky. Harold Samuel is the soloist in the Bach Pianoforte Concerto No. 3 in D on Wednesday, and those two famous women violinists, Jelli D'Aranyi and Adila Fachiri, will play the Concerto in D minor for two violins and strings.

As a general rule only the first half of each concert is broadcast.

A GREAT SALZBURG RELAY

ALTHOUGH it is rumoured that Verdi was working on an opera based on "King Lear" at the time of his death, "Falstaff" was the great Italian composer's last published opera and is considered by many to be his finest. "Falstaff" should be the most memorable performance of the Salzburg Festival and we should be profoundly grateful to the B.B.C. for relaying two acts on Monday next, August 26th. The relay lasts from 7.15 to 10.25 p.m. (National) with an interval at 8.35.

Toscanini will be conducting the Vienna Philharmonic



Listeners'

The Armada campaign was not, of course, confined to a single battle; the action extended over a fortnight, and the technique of the play gives the author a chance to reveal what was happening on both sides.

Howard Rose will produce the play and the cast will include Harcourt Williams and John Laurie.

FIGHT FOR A CROONER

Two rival night clubs fighting for the same crooner are featured in "The Silver Spoon," Henrik Ege's musical play to be broadcast tonight (National, 8.40) and tomorrow (Regional, 8). I am told that the play is riotously complicated but that the *denouement* is both surprising and comic. The cast includes Davy Burnaby, Jane Carr and Reginald Purdell.

GALLI-CURCI OF THE AIR

ZINIADA NICOLINA, a Russian soprano who stars in a

A LIKEABLE YOUNGSTER

MONEY making is always an attractive theme in play, book or film, so "Rocking-horse Winner," in the National programme on Thursday, should indeed be a winner. Adapted by Cecil Lewis from D. H. Lawrence's book, it's the story of a boy of twelve who discovers that by mounting his rocking horse he can imagine he is riding in a horse race and can visualise the name of the winner.

Listeners will be able to follow the boy's adventures in gathering the shekels which his mother has no difficulty in spending.

ALL ABOUT THE ARMADA

SOMETHING like a running commentary on the Spanish Armada is promised by the B.B.C.'s Drama Department for Tuesday (Regional) and Wednesday (National). "Armada," by Whitaker Wilson, will be a "dramatic news bulletin" of the history of the campaign launched by Philip of Spain against England and Queen Elizabeth in July, 1588.



THE CARLYLE COUSINS, a famous trio who have a variety feature to themselves at 9.45 p.m. in the Regional programme on Tuesday next. They specialise in syncopated songs.

variety feature at 9.40 on Wednesday (Regional), has been referred to as the "Galli-Curci of the Air" by her radio audiences in America. She possesses a coloratura voice of great range and, if your set does justice to the high notes, should be heard to advantage in a programme of songs of many lands.

Guide for the Week

HIGHLIGHTS OF THE WEEK

FRIDAY, AUGUST 23rd.
Nat., 8, Serge Krish Septet. 8.40, "The Silver Spoon." 10, Promenade Concert.
Reg., 8, Beethoven Promenade Concert. 9.40, Pianoforte Recital by Shepherd Munn.

Abroad.
Vienna, 8.40, Symphony Concert by the Vienna Chamber Orchestra.

SATURDAY, AUGUST 24th.
Nat., Running commentaries on Grand Prix de l'Europe and the Ulster Grand Prix. Promenade Concert. B.B.C. Orchestra.
Reg., "The Silver Spoon." 9, Last Night at Radiolympia.

Abroad.
Rome, 8.40, Opera: "La Ghibellina" (Bianchi).

SUNDAY, AUGUST 25th.
Nat., Horsham Borough Silver Band. Yascha Krein Gypsy Orchestra. "The Last Voyage of the Otranto." 7.15, Recital by Elisabeth Schumann (soprano). Folkestone Municipal Orchestra.
Reg., Reginald King and his Orchestra. Sydney Baynes and his Band. B.B.C. Orchestra, conducted by Frank Bridge.

Abroad.
Vienna, 8.30, "Wine, Women and Song"—by the Vienna Symphony Orchestra and Choirs.

MONDAY, AUGUST 26th.
Nat., 7.15, From Salzburg: Verdi's "Falstaff."

Reg., Leslie Bridgewater Quintet. Howard Jacob's Dance Band. Pianoforte Recital by Edward Isaacs.

Abroad.
Kalundborg, 8, Auber and Offenbach concert.

TUESDAY, AUGUST 27th.
Nat., Maurice Winnick and his Orchestra. Russian Promenade Concert. Gershom Parkinson Quintet.

Reg., 8, "Armada." Stanelli's Stag Party. The Carlyle Cousins.

Abroad.
Warsaw, 9.30, Symphony Concert.

WEDNESDAY, AUGUST 28th.
Nat., B.B.C. Orchestra, conducted by Sir Granville Bantock. Medvedeff's Balalaika Orchestra. 8.40, "Armada." Transatlantic Bulletin.

Reg., 8, Bach Promenade Concert. Zinaida Nicolina, the Russian soprano.

Abroad.
Deutschlandsender, 8.45, Final broadcast from the Berlin Radio Show.

THURSDAY, AUGUST 29th.
Nat., New London Trio. Schubert Promenade Concert. 10, "Rocking-Horse Winner." Victor Olof Sextet.

Reg., 8, "Bertie the Bank Clerk, or Baham to the Bone"—musical burlesque. Recital by John Armstrong (tenor) and James Ching (pianoforte).

Abroad.
Leipzig, 8, Opera: "The Barber of Seville" (Rossini) relayed from the Altes Theatre.

HISTORICAL DRAMA

THE Italian stations seem to favour historical drama and opera very much lately, and on Saturday, at 8.40, Rome is taking us back with Renzo Bianchi's "La Ghibellina," to the stormy days of the Guelphs and the Ghibellines—the centuries-old struggle between burghers, emperors and popes, which really only ended with the advent of a united Italy under the present king's father, the great Victor Emmanuel.

OPERA AND OPERETTA

OPERA lovers have some rather unusual fare to choose from this week, but also a few old favourites. To begin with the former, on Saturday Stuttgart is giving, from midnight until 2.0 a.m. a gramophone reproduction of the Residence Theatre's festival performance of "Lohengrin." The coasts being pretty clear at this late hour, reception should be excellent. On Thursday, the 29th, Leipzig is relaying Rossini's ever-popular "Barber of Seville."

Unfamiliar and untried operas will include Johannes Müller's charming romantic "Singspiel," "The Girls of Biberach," given by Leipzig at 8.10 to-morrow evening (Saturday). "Die Schneider von Schönau," a three-act comic opera, the work of that well-known contemporary Dutch composer, Jan Brandts-Buys,

Graham Walker describes the start of the Grand Prix de l'Europe and the Ulster Grand Prix motor-cycle race at Belfast to-morrow at 4.15 (National), and at the famous Muckamore Corner the story will be told by H. W. McMullan. The picture shows the start of last year's Grand Prix.

is being given by Munich at 8.10 p.m. on Tuesday. Tonight Beromunster is giving a one-act opera by Schenk, "The Village Barber," another "dark horse" for the listener seeking novelty in light opera.

ULTRA MODERN

"LIFE in the Big City," to text of Erich Kästner, is an ultra-modern slice of life. The music is by Edmund Nick, another unknown quantity. It should be worth investigating on Saturday at 8.40 on the Kalundborg wavelength.

DENMARK'S "HENRY HALL"

LOUIS PREIL, who is known as the Henry Hall of Denmark, will introduce himself to listeners in an altogether different rôle on Tuesday evening, (Kalundborg, 7.30), when he will play the violin parts from Lalo's "Symphonie Espagnole."

NATIONAL MUSIC

AN unusual type of concert will be heard to-morrow night (Saturday) at 8.0 o'clock from Brussels (No. 1). It is a Gala Performance on "National Characteristics in Music" and comes from the Exhibition, the executants being the Radio Orchestra.

A programme of national folk music comes from the German stations at 8.10 on Monday. There will be songs and dances from the Saar district.

CONCERTS

TO-NIGHT (Friday) is particularly rich for music lovers. At 9.5 p.m., Budapest (No. 1) has a Weber, Schubert, Wagner and Goldmark programme by the Opera Orchestra, with



"FALSTAFF" FROM SALZBURG. Toscanini conducts Verdi's great opera in a performance to be relayed by the B.B.C. on Monday evening. Above is Dusolina Giannini, soprano, who takes a leading part.

is by the orchestra of The Hague—conductor: Schuricht, and includes the Voormolen Concerto, for two oboes. Rome gives us an Amadei Concert at 8.40 p.m.

CHOOSING AN ANNOUNCER

A KNOWLEDGE of German should not be necessary to share the excitement of the final of the radio reporters' competition to be broadcast from the Berlin Exhibition from 8.10 to 10.0 on Sunday evening by all German stations. The ten regional winners will announce the musical programme and will give short reports on current events. Listeners all over Germany will be tuning in in order to vote for their favourite.

HARMONIUM RECITAL

HARMONIUM chamber music is not to everyone's taste, but for those who like it Vienna is the station to tune in at 3.40 on Sunday afternoon next. Mozart's Harmonium Sonata in C is included in a special recital on this rather neglected instrument.

BALALAIKA AND DOMRA

THE Russian virtuoso, M. Boris Borisoff, will play the balalaika and domra in a recital of Russian music to be broadcast from Motala and from Swedish stations on Saturday afternoon at 4.30.

THE AUDITOR.

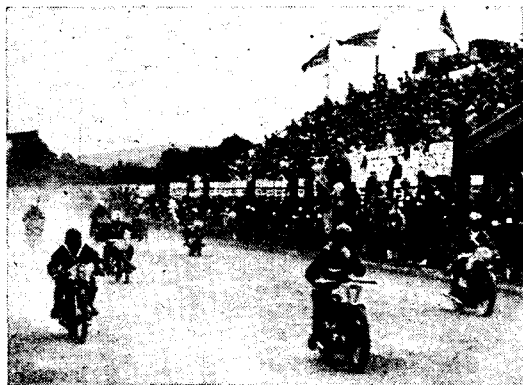

SOUND REPRODUCTION

Many Detail Improvements in Loud Speaker Design

A STEADY, if unspectacular, improvement in magnet design, and detail refinements in diaphragm construction and suspension, rather than any fundamentally new principle of operation, are the results of the year's work as revealed by the new speakers at Olympia.

If we allow the "Stentorian Duplex" as the exception which proves the rule, it must be on account of the originality with which well-tried principles have been combined in a single unit. This speaker combines a large cone diaphragm for the lower and middle frequencies with a horn-type tweeter incorporated in the centre pole of the magnet. A single magnet of special alloy supplies the flux for both sections of the speaker and is provided with series air gaps, one at the top and the other at the bottom of the centre pole. The latter is supported centrally in the block of magnetic material by white metal which is run into the annular space between. Four brass distance pieces are also inserted and the end plates of mild steel are pulled up to the magnet with countersunk screws, a certain amount of clearance being provided for accurate centring. It is stated that the flux in the 0.025-inch tweeter gap is of 13,000 lines and that a minimum of 10,000 lines is provided in the cone unit gap, which is 0.043 inches wide.

The diaphragm of the tweeter unit is of spherical form, and the pole piece at that end is "dished" to follow the contour of the diaphragm and to keep the volume of the air chamber small. The hole through the centre of the pole piece is parallel, and a tapered "bullet" is

accurately centred to give the correct expansion of cross-sectional area and to equalise the phase of the pressure wave up to the point where it reaches the flare. The latter is a bakelite moulding which is a push fit in the pole piece, and the total length of the horn is 5¼ inches.

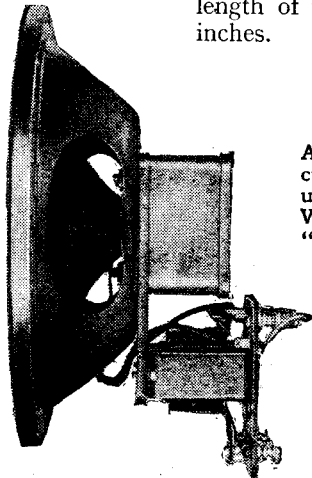

An exponentially curved cone is used in the Wharfedale "Bronze" loud speaker.

The speech coil of the tweeter unit is wound with 42-gauge aluminium wire and separate matching transformers and volume controls are provided for the two speech coils. It is undoubtedly a clever design, and we look forward to an early opportunity of investigating the performance of one of the production models.

Improved Dust Protection

In many of the single-diaphragm moving-coil speakers at the Show there was evidence of closer attention to the problem of keeping the air gap free from foreign particles. Instead of enclosing the whole unit in a dustproof bag, many

manufacturers are applying more direct methods in the form of flexible covers incorporated in the coil suspension. The Film Industries domestic units and some of the new Wharfedale and Rola models are examples of this trend.

Improvements in coil former construction and the lateral rigidity of suspension systems are widespread and will mean even fewer troubles from rubbing coils during the coming year. In the Sound Sales "Auditorium" unit a method has been found of winding one layer of the speech coil inside the former and the other outside. In addition to the improved rigidity and heat dissipation of this form of construction, the presence of a layer of insulation between the coil turns will provide a further insurance against electrical breakdown. This speaker also employs a large centring spider the arms of which are attached near to the periphery of the

Large-diameter centring spider in the Sound Sales "Auditorium" loud speaker and (inset) special

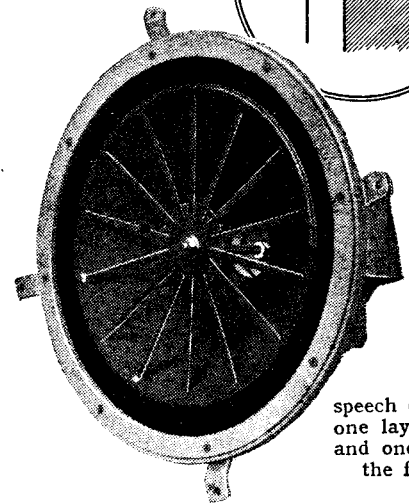
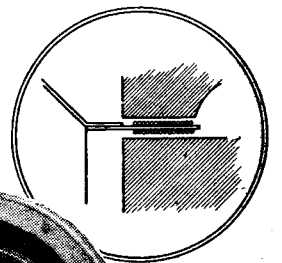

speech coil with one layer inside and one outside the former.

cone. This form of construction ensures that the movement of the coil and diaphragm is absolutely parallel to the axis and permits the development of large amplitudes. It also tends to keep the outer edge of the cone circular to prevent the effect known as "belling."

Exponential Cones

Curved cones not unlike the exponential flare of a horn loud speaker have made their appearance in the Magnavox "Thirty-Three" and Wharfedale "Bronze" and "Auditorium" speakers. The first advantage conferred by this form of construction is freedom from focusing of the high frequencies, but there is also less tendency for the increased output in the upper middle register due to "break-

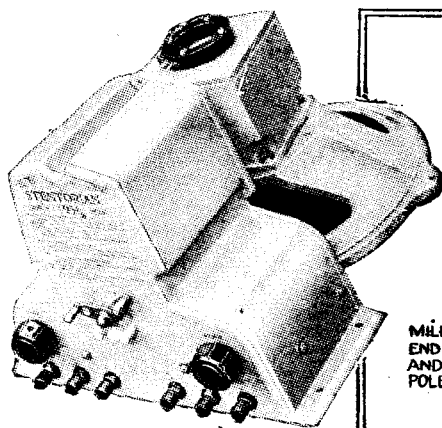

Whiteley "Stentorian Duplex" partly dismantled showing tweeter diaphragm. Note independent volume controls and output terminals. (Right) A section of "Stentorian Duplex" magnet system.

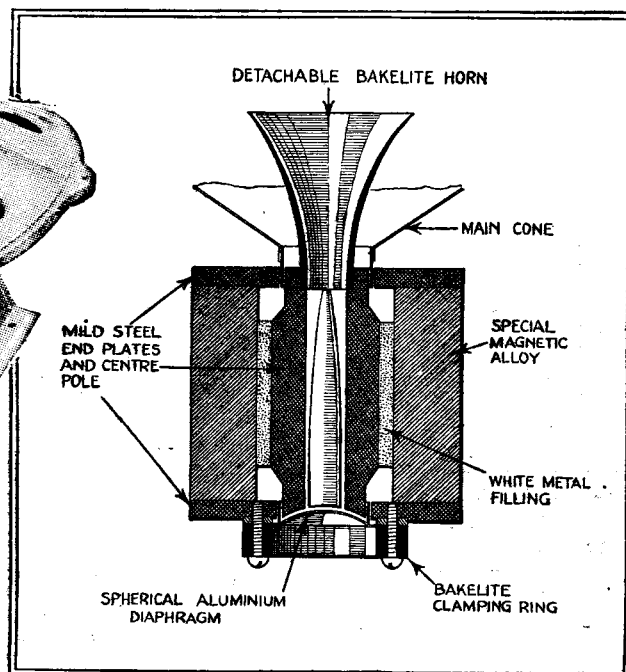

Sound Reproduction—

ing up" in the diaphragm to be centred in the resonance, which often gives coloration to the reproduction from straight-sided cones.

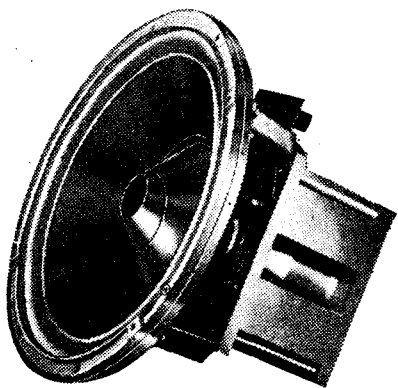

New Hartley Turner permanent-magnet loud speaker with re-entrant cone.

Modifications of the simple form of cone construction are also to be noted in the Hartley Turner range. In one of these a small subsidiary cone of a more acute angle than the main cone is attached to the apex and is designed to extend the frequency range in the extreme top. The other has a re-entrant cone attached to the apex with the object of filling out a depression in the response curve which occurs somewhere between 1,000 and 2,000 cycles.

A New Magnetic Alloy

Apart from minor improvements in the design of magnets utilising chrome and cobalt steels and nickel-aluminium alloy, the most important event to be recorded in this field of activity is the introduction by firms in the Permanent Magnet Association of a new alloy known as "Alnico," in which cobalt has been added to the already phenomenally successful combination of aluminium and nickel. As an example of the performance which is to be expected from this new material, it may be stated that a magnet employing 1 lb. of the alloy will give flux density of 8,800 lines in an air gap 1 inch in diameter, 0.040 inch wide, and $\frac{3}{16}$ inch deep.

So far we have dealt only with technical details of the construction of the new loud

speaker, but, reviewing this year's products as a whole, the appearance of a number of new and distinctive types is to be noted. The demand for light public-address equipment for use in conjunction with dance bands as well as for small outdoor gatherings has produced a number of small speakers of the directional-baffle type employing cone units of similar design to those used in domestic receivers and producing an ample volume of sound for the purpose for which they are designed, with inputs of the order of 2 or 3 watts. There are also many examples of what may be termed intermediate-priced high-quality reproducers, giving results considerably better than the small units usually fitted in receiving sets, but not so good as those of the higher grade of speakers in the £7 to £10 class.

The increasing extent to which reliance is placed on extension loud speakers has also resulted in a demand for better cabinet work and a standard of reproduction at least equal to, if not better than, that provided by the set itself. The new Celestion

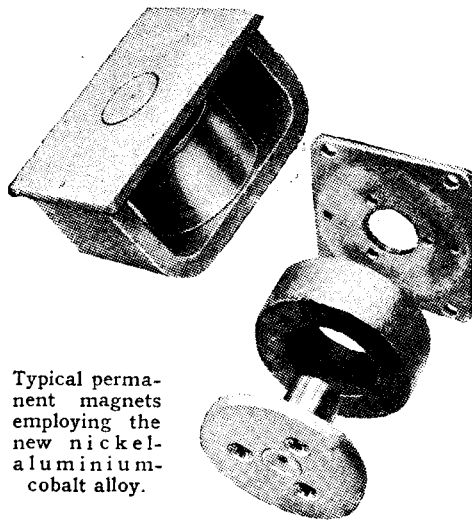

Typical permanent magnets employing the new nickel-aluminium-cobalt alloy.

extension speakers may be cited as examples of this trend.

Although the moving-coil principle still holds the premier position in loud speaker construction, the electrostatic and piezo-electric principles still hold their own for supplementary units designed to carry on where the majority of moving coils cease to emit sound in the upper register. It is now possible to buy headphones work-

ing on the piezo-electric principle, and examples of these were shown on the Sonochorde stand. It is stated that the frequency range is from 60 to 10,000 cycles, and we may expect to see an extension of the use of these headphones in aeroplanes, where, in the confined space of a cockpit, the magnets in ordinary headphones may affect the compass. The Sonochorde

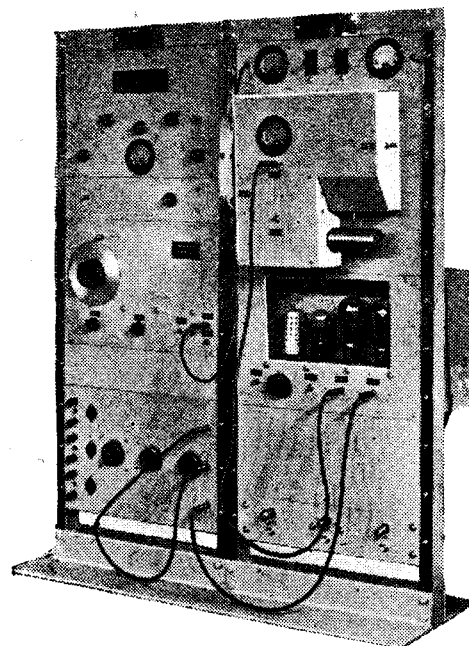

Complete loud speaker calibrating equipment built on the rack system and shown by Tannoy Products.

headphones employ a $1\frac{1}{2}$ -inch diameter diaphragm which is driven from one corner of a $\frac{5}{8}$ -inch square bimorph crystal element.

In conclusion we note with satisfaction that several firms have installed gear for measuring the frequency response of their loud speakers, and are publishing curves of their models. The laboratory apparatus used in the development of Magnavox speakers was shown on the stand of Benjamin Electric, Ltd., and an installation built on the rack system, which is shortly to be placed on the market, was shown by Tannoy Products.

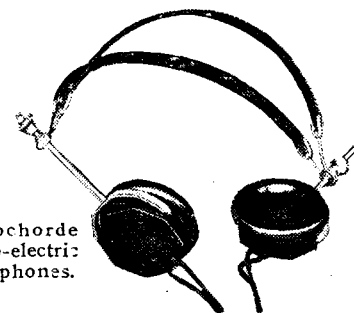

Sonochorde piezo-electric headphones.

The Radio Industry

A DATA chart relating to American valves, with sketches showing base connections, is issued by Henry Ford Radio, Ltd., 56, Howland Street, Tottenham Court Road, London W.1.

To keep pace with the rapid expansion of commercial air transport, Marconi's Wireless Telegraph Company has found it necessary to extend its service facilities. The main service depot at Croydon Aerodrome comprises both repair shops and stores, and repairs and replacements of all kinds can be effected expeditiously.

Our attention is drawn to the fact that all Belling and Lee interference-suppression devices conform to the recently issued British Standard Specification, reviewed in our issue of August 2nd.

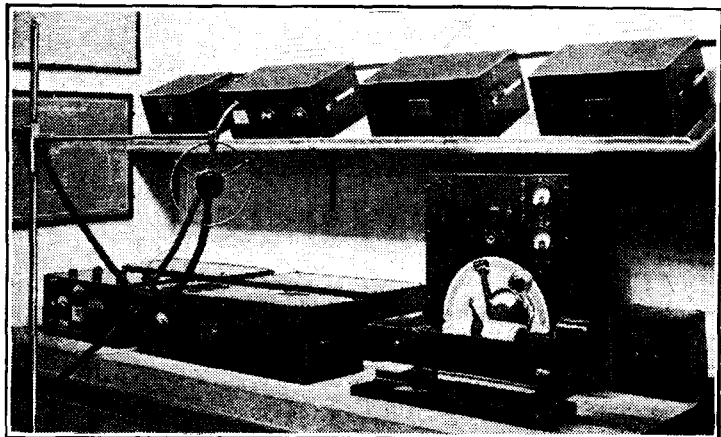

Laboratory apparatus used for measuring the response curves of Magnavox (Benjamin) loud speakers.

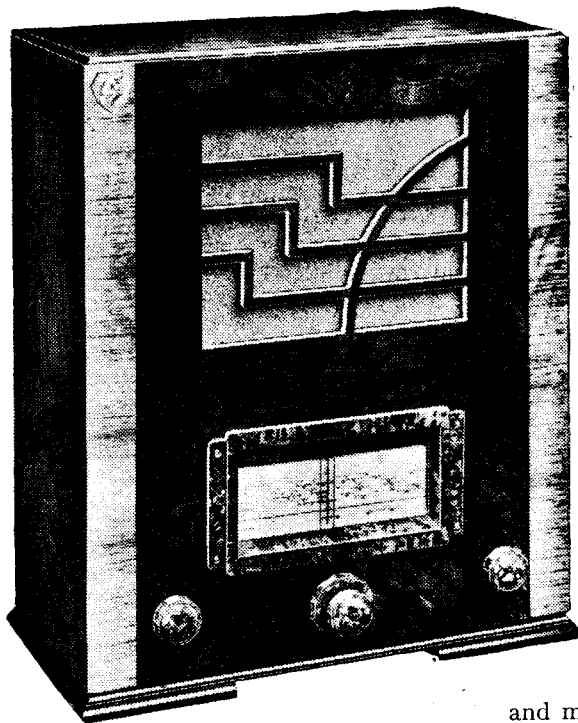

Mullard MU35

A Universal Superhet with a Novel Tuning Scale

FEATURES.—*Type.*—Table-model superheterodyne for A.C. or D.C. Mains.—*Circuit.*—Octode frequency-changer—var. mu pentode IF amplifier—double-diode second detector—triode LF amplifier—pentode output valve. Half-wave valve rectifier. *Controls.*—(1) Tuning. (2) Waverange and on-off switch (concentric with tuning control). (3) Volume. (4) Tone. **Price.**—12 guineas. **Makers.**—Mullard Wireless Service Co., Ltd., 111, Charing Cross Road, London, W.C.2

THIS is the first receiver working on the superheterodyne principle to be associated with the name of Mullard. Previous sets have been of the simple HF-det.-LF type, usually for battery operation, but the MU35 is designed to work from the mains and can be plugged into AC or DC supplies of any voltage between 200 and 250 without any preliminary adjustment. The set is entirely shock-proof, for not only are all accessory terminals isolated by condensers inside the set, but the removal of the back automatically disconnects the mains supply.

One of the most interesting features of the set is the design of the tuning scale. The station names have been arranged in parallel lines each of which is allocated to one of the principal European countries. This is of considerable help to those who make a habit of foreign listening and at

the same time those who confine themselves to the B.B.C. transmissions will find all home stations collected on the top line and marked with a distinctive colour.

The four-valve circuit is of advanced design and comprises an octode frequency-changer, variable-mu pentode IF amplifier, double-diode detector and AVC valve, separate triode LF amplifier and output pentode. The frequency-changer is preceded by a band-pass filter in which capacity coupling is employed at both the high and low potential ends of the coils. The low potential coupling is altered by the waverange switch to suit the conditions on medium and long waves. In parallel with the aerial coupling is a filter designed to exclude interference at the IF frequency, and a resistance-capacity feed isolates the aerial system in accordance with the policy of making the set entirely shock-proof.

Noise Suppression

The arrangement of the frequency-changer and IF amplifier circuits is

straightforward and in the second detector stage one diode, which is fed from the secondary of the IF transformer, is used for signal rectification and the other, fed from the primary, supplies the AVC bias. The method of obtaining inter-station noise suppression is simple and effective. The load resistance of the signal diode is returned to the slider of a potentiometer which constitutes the cathode bias resistance of the IF valve. Under conditions of no signal the current in this resistance is a maximum and the voltage developed is used to bias back the signal diode so that no rectified output reaches the LF stages. When a station is tuned-in and the current in the IF valve is reduced by the AVC, the bias on the signal diode is removed and this part of the circuit can function in the normal way. The point at which the QAVC comes into operation can be adjusted by the position of the slider on the potentiometer, and a control at the back of the set has been fitted for this purpose. The values required to ensure satisfactory operation of the QAVC control would result in too great a negative bias for the IF amplifier, and in order to

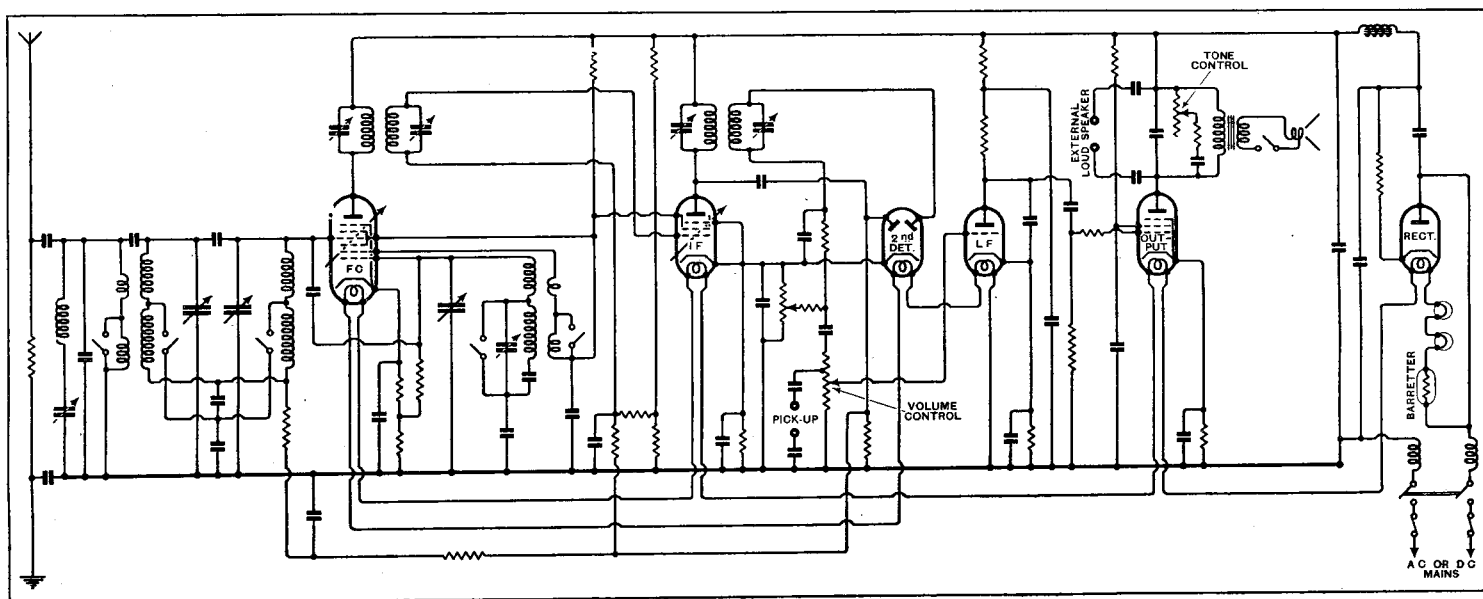

Complete circuit diagram. The pick-up, external loud speaker and aerial and earth connections are all isolated with condensers, and the mains leads include low-resistance HF chokes.

Mullard MU35—

restore the correct working conditions at the grid of this valve a small positive bias is applied from a potentiometer connected across the main HT supply.

The triode LF amplifier between the detector and output stages is resistance-coupled and the volume control in its grid circuit operates both on radio and gramophone. The pentode output valve is supplied with a continuously variable tone

a large percentage of the stations marked on the dial could be received under daylight conditions. The tests for selectivity were carried out with the QAVC control out of action. It was found that interference was completely lost outside a band two channels wide on either side of each of the two Brookmans Park transmitters. On long waves all the important stations came in with ample reserve of volume with the exception of the Deutschland-

Next Set Review

BURTON AS5

The automatic volume control is fully effective, and no difference in volume level could be detected by the ear when changing quickly from the North Regional to the London Regional programme.

The valves took some time to heat-up on first switching on the set, and although the makers give from two to three minutes as the normal period, our own test gave the more favourable figure of 1½ minutes. The temperature rise of the set as a whole after a prolonged session was considerably lower than that of the average universal receiver, and due to the adequate ventilation of the back there was no localised heating.

Matter and Motion

A Supplementary Text-Book for Students of Elementary Physics and Chemistry. By C. H. Creasey. Pp. 122. English Universities Press. 1935. Price 2s. 6d.

This little book, written by a former H.M. Inspector of Schools, treats in an elementary and discursive fashion of the subjects of mechanics and chemical physics up to matriculation standard. As the title implies, it is a book which, without examples and with a minimum of formulæ, explains (and very delightfully, too) the more difficult elementary conceptions which the average text-book fails to elucidate. The kinetic theory bulks large in the subject-matter under such headings as flying particles, particles under restraint, and particles in bondage. In subsequent chapters we are led without any abrupt transition into the chemical aspects of the kinetic theory, and we hear of loose coupling and of family groups. There is also a sketch of the subjects of waves and radiations as far as they can be pursued in an elementary treatise.

Mr. Creasey has performed a useful task in giving to us in a fresh and sparkling manner an account of the kinetics of matter which should command a wider audience than the young people to whom the book is addressed. R. T. B.

Radiotechnica, Vol. I. By E. Montù, Member of the Radio Committee of the Italian National Research Council; published by U. Hoepli, Milan, 1935; 20 lire, xix+216 pp., with 160 illustrations, glossary in Italian, English, French and German, tables, and abacs. The present volume deals with "Fundamental Principles"; Vol. II will be entitled "Electronic Valves"; and Vol III "The Practice of Radio Transmission and Reception."

"**The Wireless Engineer.**"—The September Number, published on the 1st of the month, will contain a special report on matters of technical interest at Olympia. In addition to special articles *The Wireless Engineer* also contains each month a very full service of abstracts of all the important technical articles appearing in foreign and English journals. Price per copy 2s. 6d. net. Obtainable from all bookstalls on order, or direct from the publishers of *The Wireless World*.

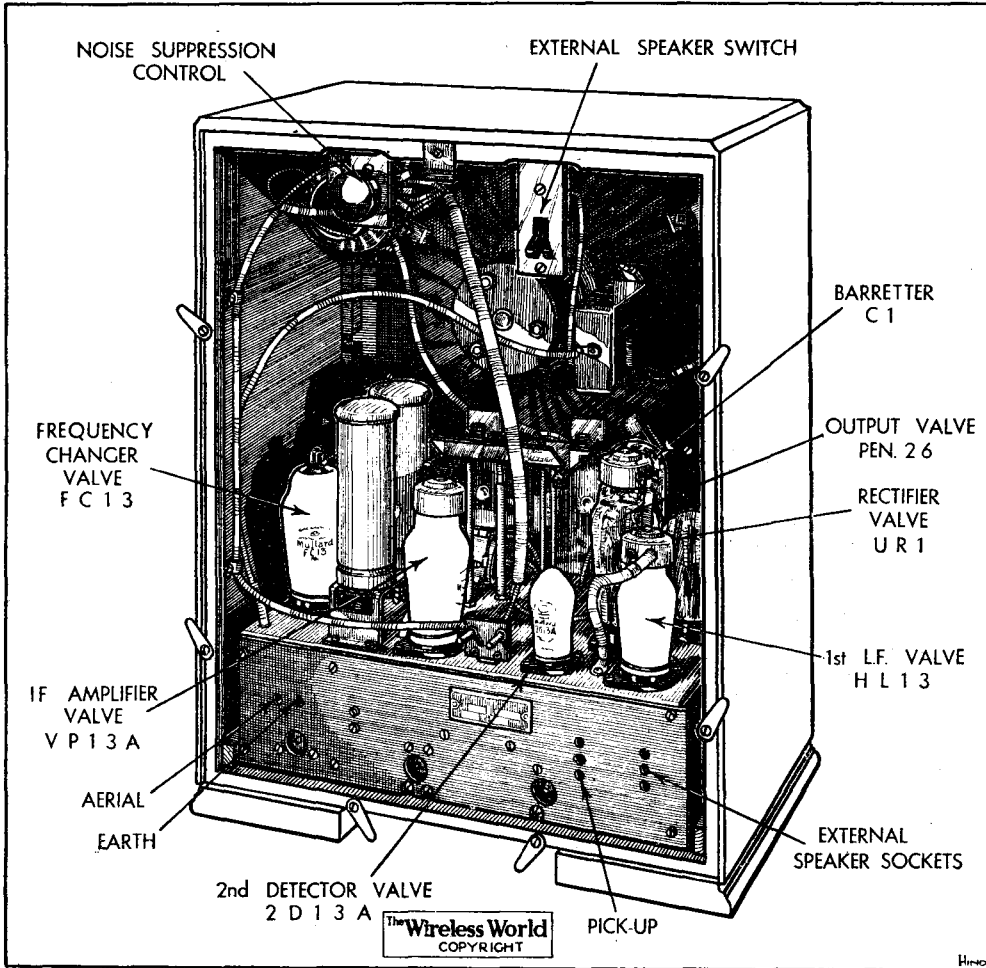

When the back of the set is removed the mains leads are automatically disconnected. Note the mains HF chokes behind the noise suppression control.

control connected across the primary of the output transformer. The external loud speaker connections are also taken across this winding so that a high impedance load will be required. A switch at the back of the set is included in the secondary circuit so that the internal loud speaker may be disconnected if desired.

The half-wave rectifier valve is indirectly heated and a barretter lamp is connected in series with the filaments to compensate for variations in the mains voltage. Low-resistance HF chokes are connected in both main leads to prevent interference reaching the set through this channel.

Even with the inter-station noise suppressor control out of action and with the set working at maximum sensitivity, the background noise was remarkably low on both AC and DC mains, the latter being known to be a troublesome source of interference noise.

The sensitivity of the set was such that

sender, which could not be cleared of interference from Droitwich and Radio-Paris. The long-wave band was free from self-generated whistles, but on the medium-wave band two fairly prominent heterodynes were noted at approximately 320 and 460 metres.

Reserve of Output

The quality of reproduction is much above the average and is of the clear type in which the various instruments of the orchestra seem to stand apart without acoustic cross-modulation. The bass response covers a wide range and the pedal notes of the organ revealed no obvious resonances in that region. With the set working at full volume the upper register seemed to require some attention from the tone control, but the reserve of output in this region is a useful asset in correcting the tonal quality of some of the Continental stations.

Mechanical Highlights Seen at the Show

Interest at Olympia No Longer Confined to Circuits

AS the designer has had fewer purely electrical innovations than usual with which to concern himself during the present season, it is natural that greater attention has in most cases been paid to the mechanical details of the new sets. As a result this year's productions are certainly better engineering jobs than anything previously turned out by the wireless industry.

Although the subject is, perhaps, a rather joyless one, it should be put on record that the new sets hold out greater promise of immunity from breakdown than their predecessors. And, to continue on the same or even on a more doleful note, if faults do develop it will be easier than ever before to put them right. It appears that the almost universal practice of suspending components merely by their connecting wires has been responsible for a good deal of trouble lately, and so several manufacturers are now avoiding it altogether. In the Ferranti Lancastria and Halcyon chassis, for example, it is noticed that clips and supporting brackets are provided for even the smallest and lightest condensers and resistances. The same tendency is noticeable elsewhere, and perhaps a final look-round will show that it has been carried to an even greater length.

In the matter of accessibility the Hal-

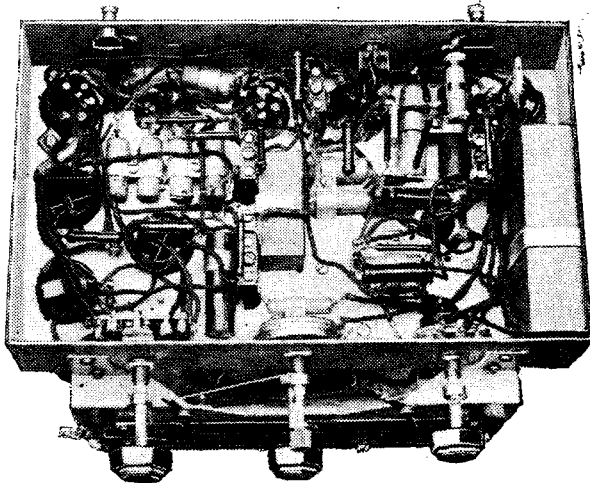

The components of the Ferranti Lancastria are arranged on the single-layer principle for accessibility, and are all firmly supported.

cyon set already mentioned is so arranged that the chassis may be withdrawn for test or examination with a minimum of trouble. An even more unconventional method of providing access to the com-

ponents is to be found in the R.G.D. Model 704 radio-gramophone; the chassis is mounted on its side in such a way that its under-side (or what would normally be its under-side) is uncovered merely by



To provide good accessibility, the chassis of the R.G.D. Model 704 is mounted on its side, and is covered by an easily removable side panel.

removing a side panel.

But let us turn to more cheerful topics than faults and their rectification, and, as a start, take the Aerodyne remote-control tuning system, which is both mechanically and electrically a highlight of the Show. When our readers tried their hands, over a year ago, at designing receivers that were intended to be much more convenient in operation than the average specimen, many of the most promising efforts called for some form of remote control. But, at the time, no mechanical device generally available offered the possibility of sufficiently close adjustment for controlling the tuning system of the modern set, and so these schemes have had to remain in abeyance.

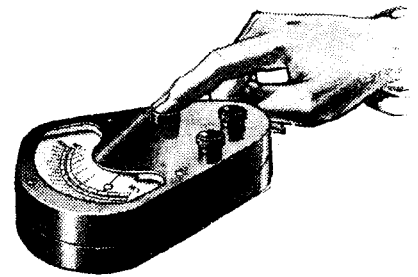

Armchair tuning: the remote-control unit of the Aerodyne set.

The Aerodyne solution of the problem is a dual one, both mechanical and electrical. The tuning condenser is rotated slowly by an electric motor by pressing a button at the remote point, which controls both forward and reverse rotation; on reaching roughly the desired tuning position the final operation of precise tuning is carried out electrically. In effect the receiver circuits are pulled into precise resonance. The control unit at the distant point carries a scale over which a pointer moves in sympathy with that on the set itself; this is done electrically, and there is no mechanical connection between the receiver and control panel.

Studying Comfort

With regard to the convenience of operating directly controlled receivers, particularly those of the upright console type, which are becoming popular, there seem to be two sharply but fairly evenly divided opinions. One school of designers maintain that the users of their sets will operate them while standing up, and accordingly mount the tuning scale at a convenient angle of about 45 degrees with the horizontal. The other says that the average listener prefers to sit down to the job, and so provide a vertical scale. Ferranti seems solid for the first method, while H.M.V. caters for both in different models.

Tuning scales are generally much larger and more readable than formerly, and

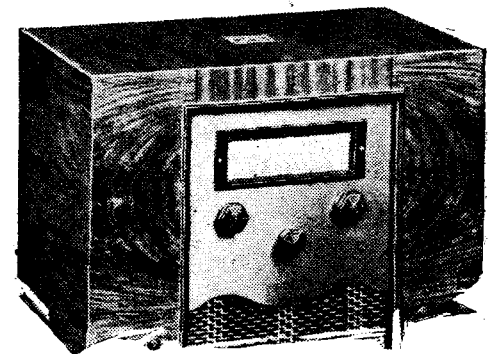

An H.M.V. console with vertical tuning scale for operation while seated.

Short-wave Broadcasting

More Listening Below 50 Metres

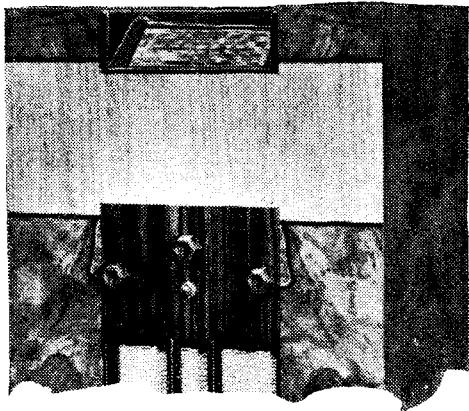

For "standing-up" operation: the sloping tuning panel of a Ferranti console receiver.

when nearly everyone is moving in what is obviously the right direction it would be invidious to pick out any particular firm for commendation—or the reverse. With the principal exception of the C.A.C. "scanning disc" dial, described elsewhere in this issue, most of the scales are on conventional lines, but the geographical grouping of stations by nationalities in the Mullard sets is a new idea.

Why should the user of a battery set have to remove the back of his set, possibly taking out several screws in the process, merely to change the LT cell? He often has to do so, but in the new H.M.V. superhet a neat trap-door with a hinged bar is provided. These little details, perhaps unimportant in themselves, are indicative of the general clean-up process that is going on.

In general, the basic layout of the typical set has undergone no change, but there are two or three receivers which show unusual methods of construction. In the latest Allwave International model a folded metal chassis provides not only mechanical support, but also electrical inter-stage screening, and, what is possibly more important in an all-wave set, the shortest possible grid and anode leads; with this object the valves are placed with base and cap of alternate ones adjacent.

Two of the new Ekco sets are also laid out on unconventional lines. The Model 76 has an L-shaped chassis, with components mounted on all four sides of the assembly; this provides in effect three screened sections. In the frame-aerial superheterodyne a double-deck chassis is used with the receiver above the power equipment. Although this construction, which gives improved accessibility, is often used in specialised receivers, it is seldom found in a standard broadcast set. Incidentally, the Ekco sets look extremely workmanlike, and the technique of handling bakelite as a cabinet material seems to have been thoroughly mastered.

IT is hardly necessary, in view of the profusion of material elsewhere on the subject of the Exhibition, to stress the fact that short-wave broadcasting is receiving very fine publicity at the moment. So many all-wave receivers are in evidence that the more sceptical members of the listening public are, at last, beginning to realise that there really are broadcasting stations below 50 metres and that it is not entirely a matter of imagination.

Most of these all-wave receivers have a short-wave side so designed that it is, in general, only suitable for the reception of fairly strong broadcast. This is as it should be, as it is only that aspect of short-wave work that is likely to appeal to the purchaser of a fairly expensive receiver.

The staggered valve mounting of the Allwave International set provides extra screening and short paths for grid and anode leads.

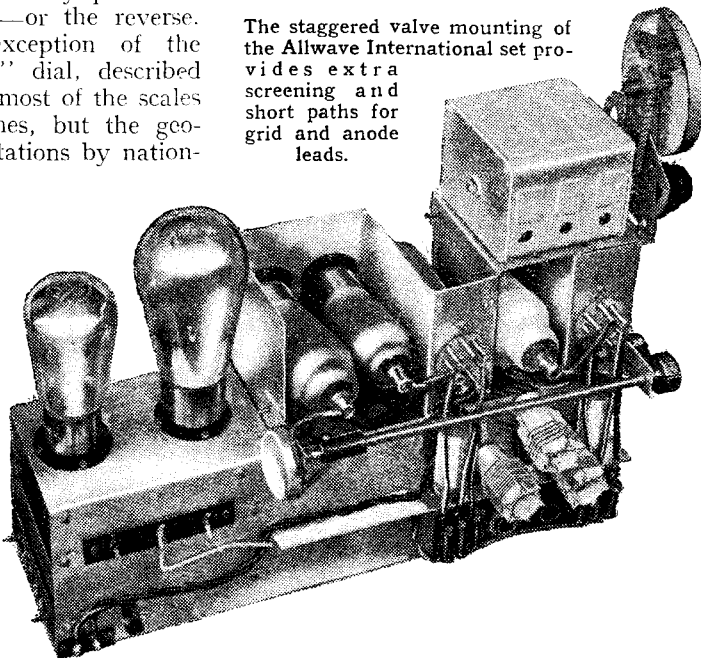

Some of the short-wave receivers at the Show, however (although they are mostly intended for export) are real "all-round" sets, which will do anything that a specially designed and home-constructed receiver will do.

Short-wave broadcasting will undoubtedly be coming before a much wider public this winter, and it is to be hoped that conditions will remain favourable and give them a first impression that is not a disappointment.

At the time of writing an all-wave superheterodyne is in use, and about twenty-five short-wave stations can be received at really good strength. W2XAD (19.56 metres) and W8XK (19.72 metres) are, as usual, the best Americans. Rome and Zeesen are usually stronger than any stations heard on the medium waves except the local National and Regional; and the next best stations are the 49-metre South Americans.

Sydney (VK2ME) has not yet been heard, owing to absence on one Sunday and appalling local interference on the next. There obviously will not be any trouble in receiving real programme-value from that station, however.

Readers who are able to listen between midday and 4 or 5 p.m., even if only at week-ends, will do well to keep a close watch on the band between 19 and 10 metres, on which several very interesting transmissions have recently appeared.

OPL (Leopoldville, Belgian Congo) was recently heard, testing with Brussels, at a perfectly amazing strength. The wavelength was about 15 metres. Rio de Janeiro (PSA) has also been heard on 14.2 metres, just above Buenos Aires (LSL) on 14.19. Both these stations were considerably stronger than the average South American station above 30 metres.

Many of the stations between 19 and 10 metres, although listed as commercial or experimental, may be heard putting out some sort of musical programme from time to time. Bandoeng (PMA) on 15.5 metres seems to make a regular habit of it.

South American Newcomers

A new station in the 25-metre band is Sancti Spiritus, Cuba (CO9WR). This station has been logged between 10 p.m. and midnight on several occasions, and by several readers. Medellin, Colombia (HJ4ABA) is the only representative of South America on this band; he works on 25.6 metres, just below Pontoise, and may be heard from 11 p.m. or 11.30 p.m. onwards.

Other comparatively new stations worth looking for are Panama City (HP5J) on 31.28 metres, Havana (COH) on 31.8 metres, Guayaquil (HC2AT) on 35.72 metres, and Dordrecht (PI1J) on 42.4 metres.

New schedules for the 19-metre band will probably be announced within a week or so, as the fade-out is occurring perceptibly earlier every night.

Just now the 31- and 25-metre bands are rather uninteresting, and it pays one to listen mostly on 19 and 49 metres, apart, of course, from the amateur bands, which always seem to be filled up.

MEGACYCLE.

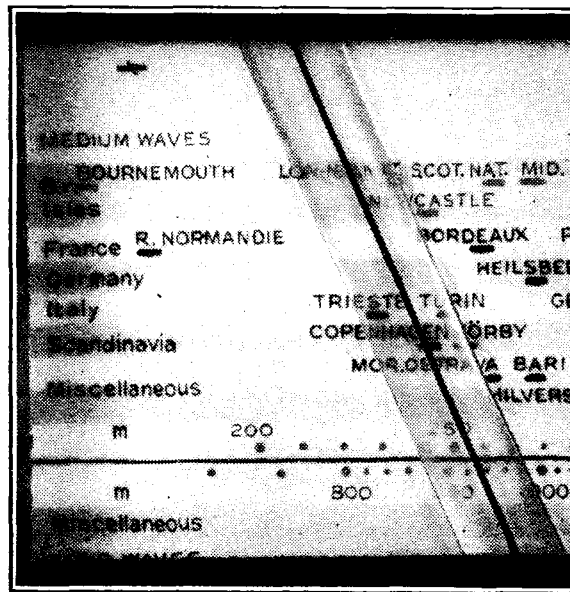

Part of the "geographical" station-name scale of a Mullard receiver.

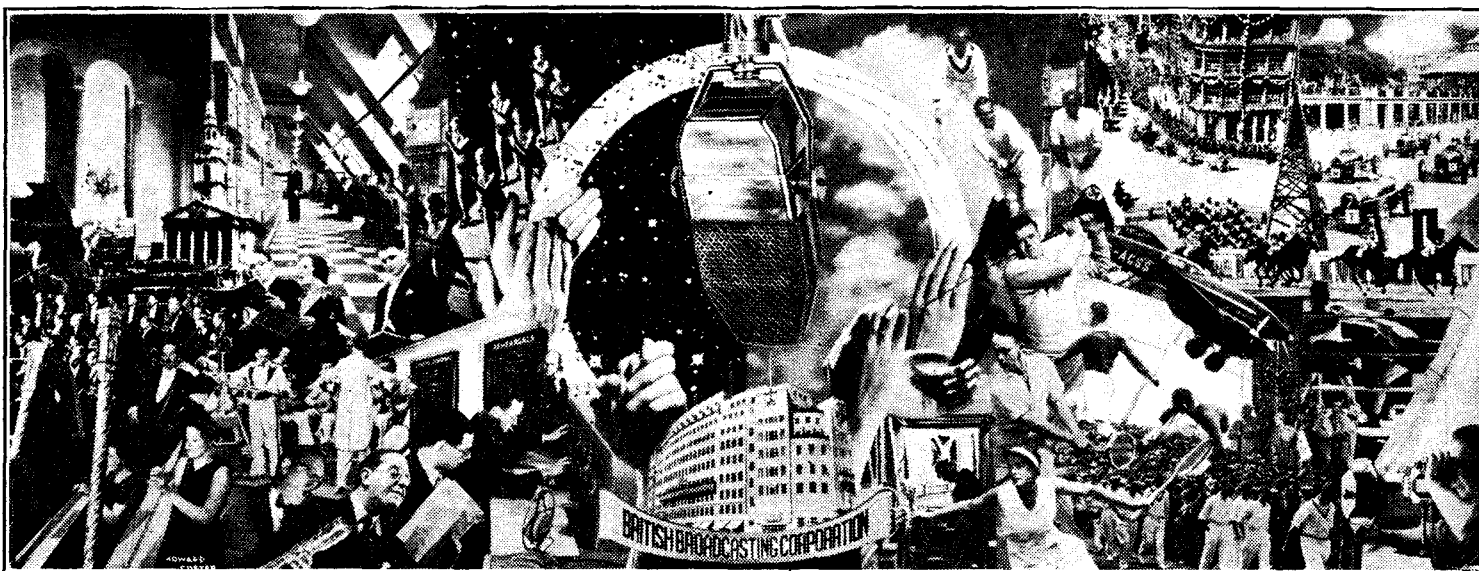

BROADCAST BREVITIES

Variety with the Lid Off

IT is great fun watching broadcast variety with the lid off in the theatre at Radiolympia, but, in my view, the cream of the entertainment is to be had in the semi-darkened hall when Eric Maschwitz, John Sharman, and Brian Michie are rehearsing the dress rehearsal.

Rehearsal

At least this is what I think I was witnessing last week. To the accompaniment of a mixed grill of noise—carpentry, organ tuning, arguments—"In Town To-night" held the stage in the middle of the afternoon.

Cabman and the Mike

The engineers' dexterity in placing the ribbon microphones is interesting to watch. Those who have seen the show recollect the surprising entrance of a hansom cab complete with horse and driver.

At rehearsal the hardest job was to make it easy for the cabman to drive in without having his hat knocked off by the suspended "mike." He had to come near enough to the dangerous looking instrument to give his remarks the confidential touch, but the old grey mare seemed doubtful.

Michie as Genuine Constable

By the way, that giant, Brian Michie, unknown to the audience, is playing a dual rôle on the stage. Dressed as a policeman he is part of the London scene, but his ulterior purpose is to keep things on the move like a real policeman, and instil confidence into the nervous amateurs who make up the cast for "In Town To-night."

By Our Special Correspondent

Why Not In Latin?

Over the proscenium arch there is a beautiful superscription exhorting those who are watching their favourite radio stars to hear them on a modern radio set.

Talking with various B.B.C. impresarios I found general wonderment that the motto was not in Latin. But, after all, what is the Latin for Alec Moody?

Those Dummy Pipes

It was a pity, I thought, that the remarkable Electrone organ was hidden by a stack of dummy pipes. If the little black box, four feet square, which houses the entire mechanism could have been displayed in all its minuteness, the general public would have been given a more truthful impression of the Compton Organ Company's achievement.

Coping with the Bass Notes

As it is the ordinary man might be forgiven for thinking he was hearing an improved cinema organ. The lowest pedal note corresponds to a 16-foot pipe (32 cycles). The electrical reproduction of the pedal notes is effected by means of a bass chamber designed specially for the occasion. Four Voigt units with double power diaphragms are used, while other Voigt units with appropriate horns are used for the middle and upper frequencies.

Few aspects of British broadcasting are omitted from the illuminated photo-mural displayed on the B.B.C. stand at Olympia. Above is a reproduction of the central panel of the triptych. The right-hand panel, dealing with Corporation's technical activities, is shown on page 239 of this issue.

Railway on the Radio

VERY wisely the B.B.C. will not spoil the Great Western Railway Centenary broadcast by introducing the comic element as in the case of the L.N.E.R. programme a few weeks ago. The devisers of the programme which is to be given on the National wavelength on August 31st hope to bring pleasure to many thousands of railwaymen all over the country. The programme will be based on a journey from Paddington to Penzance with side trips through the Welsh border and up to Swindon.

Records en Route

The driver of the Cornish Riviera express will take part, and there will be records provided by the mobile recording unit. These have definite entertainment value, but to the technically minded railwaymen they will be "musical" in more senses than one.

National Radio Debt

BRITISH listeners are at the moment under a debt of obligation to the American broadcasting networks, both N.B.C. and Columbia. In other words, the number of hours of programme material relayed in this country from America is out of all proportion to the meagre amount of entertainment we have broadcast to the other side.

Reciprocation?

It is true, of course, that time and the Heaviside Layer conspire to make it easier for us to hear America than for America to tune in to us, at any rate on the medium and long waves.

The B.B.C. is, however, seriously considering wiping out the debt, possibly by means of recorded programmes which may be relayed during the evening listening periods in America.

B.B.C. Offices in New York

Another important step towards strengthening the ties between the English speaking peoples may soon be taken by the establishment of B.B.C. offices in New York. This move was, in fact, suggested editorially in *The Wireless World* of July 12th.

One of the Corporation's own staff would be put in charge, and his duties would include, among other things, the studying of American broadcasting conditions the choice of suitable programmes for relaying to this country and general liaison work.

Why Not In Empire Cities?

But if New York is to have a B.B.C. "ambassador" why not Ottawa, Melbourne, Cape Town, and other important cities of the Empire? Canada and South Africa, which have both adopted the B.B.C. type of organisation, should certainly be included in the scheme.

Goodbye, Vienna . . .

"THE Night Life of Budapest" is the title of a series of four B.B.C. broadcasts on September 24th, 25th, 27th and 28th next, featuring café and cabaret life in the Hungarian capital.

Applications of the NEW VALVES

A Brief Review of Some of the Latest Types

DEVELOPMENT in valves is now steadily carried out by the various firms concerned, and the results are no longer kept back until the Olympia Exhibition, but are made evident in a steady stream of new types throughout the year. Consequently, although the specimens presented as brand new at the show may seem fewer than usual, the new valves produced during the radio year which has just ended are hardly less numerous than before.

A newcomer which happens to coincide with Olympia is the Marconi and Osram X41, and it is a valve which is of particular interest to the short-wave enthusiast. It is a triode-hexode frequency-changer, and on the medium and long waves its chief advantage over the heptode is its higher internal resistance. On short waves, however, two distinct merits are claimed for it—the ease with which oscillation can be obtained and the absence of interaction between the signal and oscillator circuits. The hexode section has variable-mu characteristics and it is recommended that the triode section be used with a tuned-anode oscillator as shown in Fig. 1.

The amplitude of oscillation should be adjusted to produce about 12 volts on the triode grid, and this is checked most readily by measuring the current through the 50,000 ohms grid leak; it should be about 0.2 mA/V, but the amplitude of oscillation is by no means critical and quite wide variations from the optimum affect the efficiency to only a small degree. The valve is for AC operation with a 4-volt heater, but an AC/DC model, the X31, is also available; this, of course, has a 13-volt 0.3 ampere heater.

The Hivac output tetrode, known as the Harries valve, can be substituted for an ordinary pentode without involving any changes in connections beyond seeing that

the bias resistance has the correct value. The characteristics are claimed to be straighter than those of a pentode and the output for a given degree of distortion to be greater. The midget valves shown by this firm involve no special technique, for they can be treated in exactly the same

vides detection, delayed AVC, and an output of some 3.5 watts. The values shown on this diagram vary somewhat with different makes, but they will permit a good performance with any valve. The only component with regard to which the maker's instructions must strictly be ad-

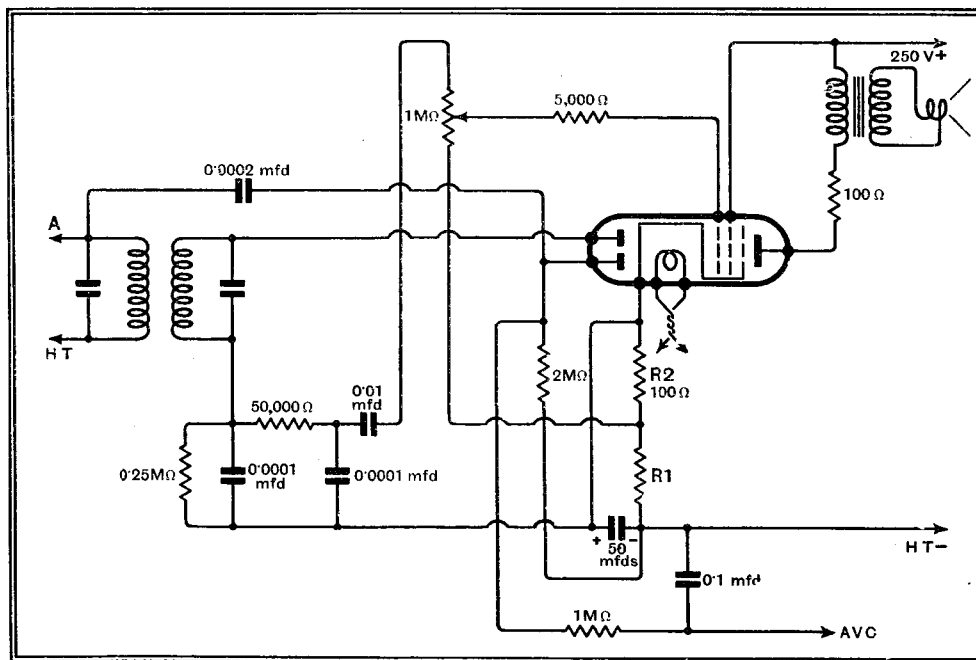

Fig. 2.—Typical connections for a duo-diode output pentode are given here. The AVC delay voltage is governed by the value of R1.

way as the ordinary valves. Owing to their small size, however, they lend themselves well to the construction of portable apparatus. They are also available with Frequentite bases and these specimens should appeal to those interested in short and ultra-short wave reception.

Another valve which is to be found in nearly every maker's range is the duo-diode output pentode. A typical circuit is shown in Fig. 2, and it will be seen that it pro-

hered to is the bias resistance R2. The amount of delay on AVC is controlled by R1, and it will usually be satisfactory to make this resistance about 100 ohms. Typical valves of this type are the Marconi and Osram DN41, the Mazda Pen DD 4020 and AC2/Pen DD, and the Ferranti PT4D, PTAD, and PTSD.

Universal type valves are employed chiefly in AC/DC sets at the present time, but since the majority of them have 13-volt heaters, they are suitable for car sets and are often employed for this purpose. Output valves and rectifiers of the true AC/DC type usually require a higher heater voltage, so that many makers duplicate these types in different heater ratings. Thus the Ferranti PTSD has a 26-volt 0.3 ampere heater for AC/DC sets, while its counterpart for car radio, the PTAD, has a 13-volt 0.6 ampere heater.

The question of obtaining large power output has not been ignored during the past year, and the "low-loading" system enables 30 watts to be obtained from a pair of PX25A valves. A pair of the new DA30 valves will give 45 watts in this system with only 500 volts HT. At the other end of the scale, the battery user has the choice of QPP and Class "B." Mullard have the PM2B Class B valve and the QP22A double-pentode which has

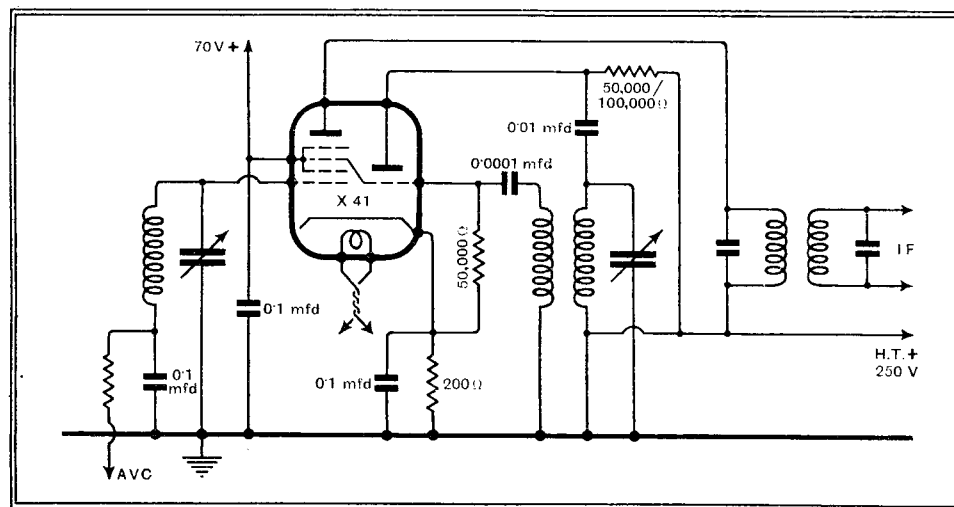

Fig. 1.—The recommended circuit connections for the triode-hexode frequency-changer are shown here. A tuned-anode oscillator circuit is advised for the best results.

Applications of the New Valves—

a 9-pin base and gives an output of over 1 watt. Mazda have also a QPP valve of this type, the QP240, and two Class B models, while Cossor have a Class B type rated for 2 watts output. The Marconi and Osram QP21 valves have 7-pin bases, as also have their Class B types.

Special purpose valves are beginning to make an appearance. These are not intended for general use, but for cases where specially stringent requirements render them advisable. A case in point is the first valve of a microphone pre-amplifier. The degree of amplification

needed with good-quality microphones is often so high that it is difficult to obtain good results with ordinary valves. Not only must the insulation of the grid be very good but the interelectrode capacities must be low and the valve free from microphony and other forms of noise. The Osram A537 is designed for cases such as these and it is claimed to be particularly silent in operation. It is a triode with a mutual conductance of 1.5 mA/V, and it is fitted with a top-cap for the grid. Steatite insulation is used. Although it is indirectly heated, battery operation is recommended for the most silent results.

engaged on their home-work until about the same time. As the house is a small one this makes it impossible for any kind of loud speaker set to be used during that part of the evening when some of the best programmes are going. The lady of the house has recently installed a crystal set, which enables her to listen-in when she likes without disturbing anyone else. Given a good aerial and earth, an unaided crystal set should bring in any of the 50-kilowatt Regional stations pretty well at ranges up to 40 or 50 miles. Droitwich is often well received at places 100 miles or more away. Where long-range reception is desired—or greater signal strength for those who are hard of hearing—it is a simple matter to make up a small self-contained single-valve amplifier operated by batteries. Using a valve of the medium-impedance class, which is all that is necessary for telephone working, the high-tension current drain is minute. It runs to only about 1.5 milliamperes, and, since the low-tension current is but 0.1 ampere, batteries of a very small size can be employed.

Random Radiations

By "DIALLIST"

This Year, Next Year . . .

AT long last we have an announcement from the Postmaster-General that the London high-definition television service should begin testing some time in February. Regular services are to start "as soon as practicable" after that. Mr. J. L. Baird, I see, does not expect the service to be in full swing much before this time next year—and probably he is not far out in his estimate. I don't think I am inordinately impatient by nature, but it does seem to me rather absurd that we should be kept waiting all this time for television transmissions when the Baird station at the Crystal Palace, had it been taken over as a stop-gap whilst the other was under construction, could have been conducting a most valuable series of test transmissions all this summer. Both amateur experimenters and many of the future manufacturers of television receiving sets know that there is a great deal to learn about reception on the ultra-short waves, and they would have been overjoyed to have had such transmissions available.

Why Not a Temporary Station ?

It is still not too late to bring the Crystal Palace station into action temporarily. The trouble is, of course, that two rival systems are recommended for adoption by the Television Committee and that the station belongs to one of them. Surely, though, it is to the interest of both parties to get transmissions going as soon as possible; otherwise public interest may fizzle out to some extent owing to the long wait. E.M.I. have, I believe, a plant in full working order at their Hayes factory. Could it not be arranged that transmissions designed not for entertainment but purely for the benefit of experimenters should be given on one evening a week from the Crystal Palace and on another evening from Hayes, each programme to last, say, an hour? There is no question that if these were made regularly at times previously announced great use would be made of them. For one's first experiments in short-wave reception it is not necessary to own a television receiver; a set designed for dealing with speech alone is sufficient. If, then, we cannot have experimental television transmissions during the next few

months, may we not have at least transmissions of speech on the ultra-short waves?

A Giant Receiver

I HAVE just been reading a description of a set which claims to be the largest all-wave receiver in the world, and I should think there is very little doubt that it is. This gigantic set has just been installed in one of New York's big hotels, and its output is taken to no fewer than 2,000 loud speakers situated in the various public rooms, sitting rooms and bedrooms of the hotel. In each private room there is a loud speaker provided with a rotary switch, which enables any one of the six alternative programmes that have been selected by those responsible, to be turned on. Guests are charged a fee for the use of the apparatus.

Running this great set is a big job and quite a staff is required for the purpose. The programme department selects items from both U.S.A. stations and short-wave stations all over the world. Then the engineering department discovers by test which of the short-wave programmes can be well enough received to be placed "on tap." This done, a broad-sheet is printed, showing guests exactly what is available. Three men are on duty all the time at the control panel and the distributing board.

In time to come receiving equipment of this kind may find its way into the headquarters of most broadcasting authorities throughout the world. It would be invaluable for relaying purposes, particularly for relays of the "surprise item" kind.

A Crystal Revival

ONE rather interesting feature of the Olympia Exhibition is that crystal sets are to be seen on more than one stand. I think I am right in saying that last year there was not a crystal set at the Show, and I believe that there was only one the previous year. There is no doubt that many people have come to realise lately that, so long as you make allowance for its limitations, the crystal set can be very useful. In one home that I know the husband has work to do on most evenings which demands considerable concentration. Two sons of the house are day boys at a neighbouring public school, and they are

New Post at the B.B.C.

IT was announced recently that a new post, that of Deputy Director General, had been created for Vice-Admiral Sir Charles Carpendale, who was almost due to retire, under the age limit, from his position as Controller of Staff. The new appointment will be popular, since it means retaining the services of one whom the B.B.C. could ill afford to lose. When the Admiral retired some months ago from the Chairmanship of the International Broadcasting Union the delegates were unanimous in their tributes to his tact and to his strength when strength was needed. He has been an outstanding success at the B.B.C., and as Deputy Director General he should have further and wider scope for his abilities.

An Awful Thought

WITH no small apprehension I read the announcement that the trial of a mechanical town crier at Chesterfield has proved an unqualified success and that other towns are likely to adopt the idea. The mechanical town crier, it appears, is a kind of municipal public address van equipped with gigantic loud speakers on the outside, whilst within there is both a microphone and a playing table for gramophone records. During the tests records were used, being repeated mechanically at intervals after the manner of those which bid us stand clear of the gates in Underground Railway lifts. Ingenious, no doubt, but to me the mechanical town crier seems fraught with menace. In the townlet in which I live we have a human town crier complete with quaint costume and bell. Every now and then he appears in our streets and emits curious noises. Nobody that I know has ever succeeded in understanding a word of his announcements, though, having seen advertisements and posters, we realise that he is striving to attract us to this fête, that football match, or those athletic sports. He is picturesque and, owing to his small though distorted output, merely a minor nuisance; but the loud speaker van, capable of a high tale of watts, parading our streets and lifting up its voice every few moments, is a horror not to be thought of. Let us hope that the thermionic valve will not be permitted to render this disservice to suffering humanity.

Olympia's "Side-Shows"

Provided by the B.B.C.,
G.P.O. and R.M.A.

"SIDE-SHOW" is no misnomer for two of the B.B.C. stands at Radiolympia. One, which houses the amplifying gear, is needlessly concealed from the public gaze in the south gallery, and the other, setting forth among other attractions a remarkable photo-mural of the Corporation's activities, has been deposited in an out-of-the-way corner behind the Post Office "village." Readers who accidentally stray into this remote portion of the Exhibition will discover treasure trove in the form of an historic collection of B.B.C. microphones as used since 1923, and two fine models of the Droitwich station. The anti-interference campaign provides the keynote for the other

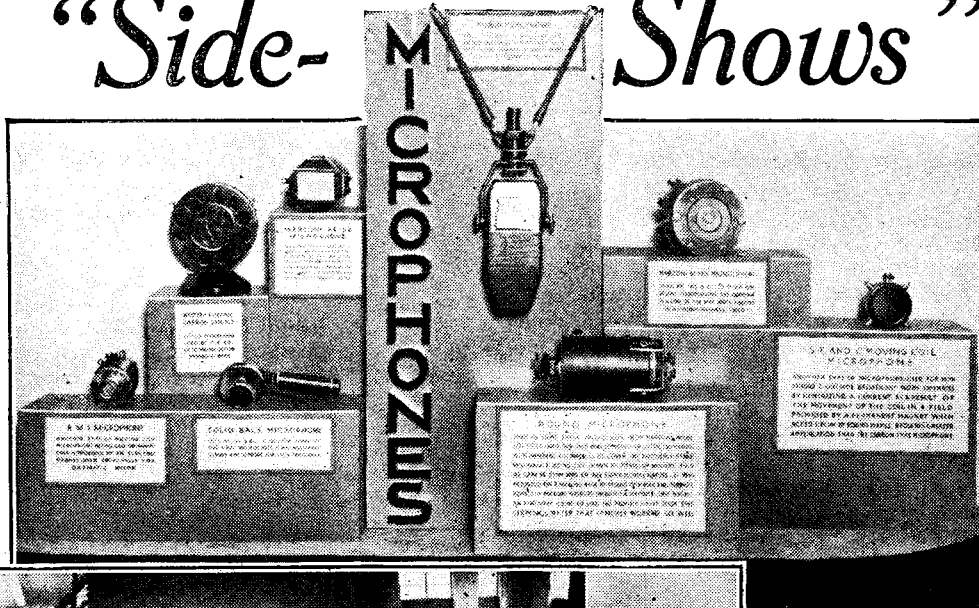

Microphones ranging from the solid-back type of 1923 to the "ribbon mike" of to-day are seen above in a photograph taken on the B.B.C.'s stand. On the left is a section of the photo-mural showing the technical side of the Corporation's work. Exterior and interior views of the Droitwich station can be picked out. The National and Midland transmitters are in the centre.

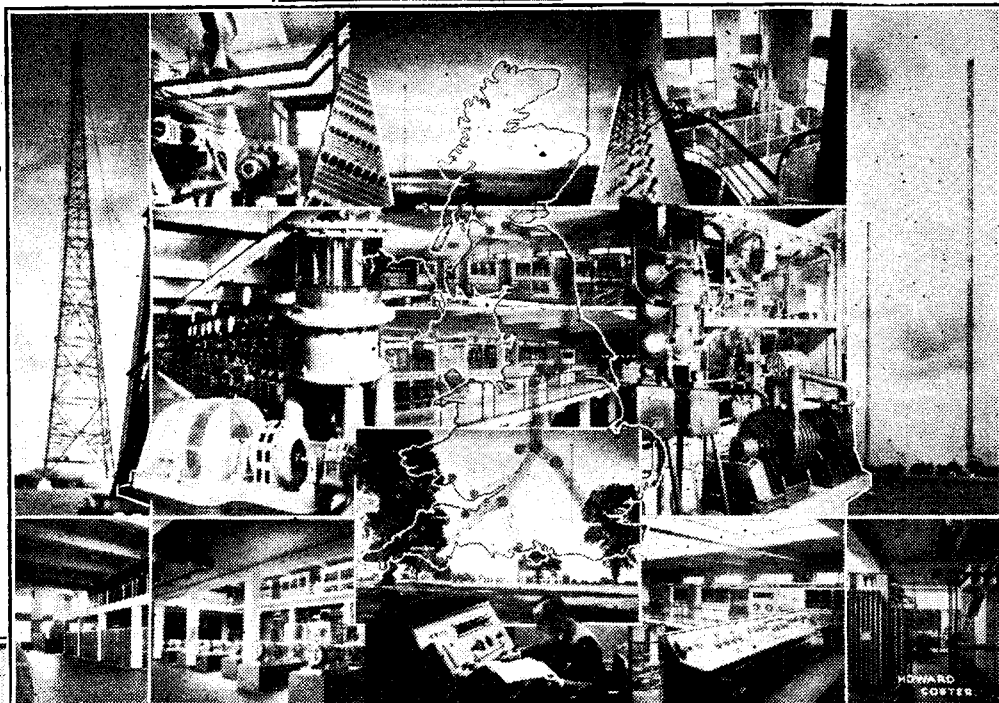

A visitor to the G.P.O. anti-interference stand takes the first step towards cutting out the crackle by filling up a questionnaire form. The right-hand photograph was taken in the screened room housing radio-therapy apparatus. The walls are sprayed with metallic compound and the window contains a wire mesh screen.

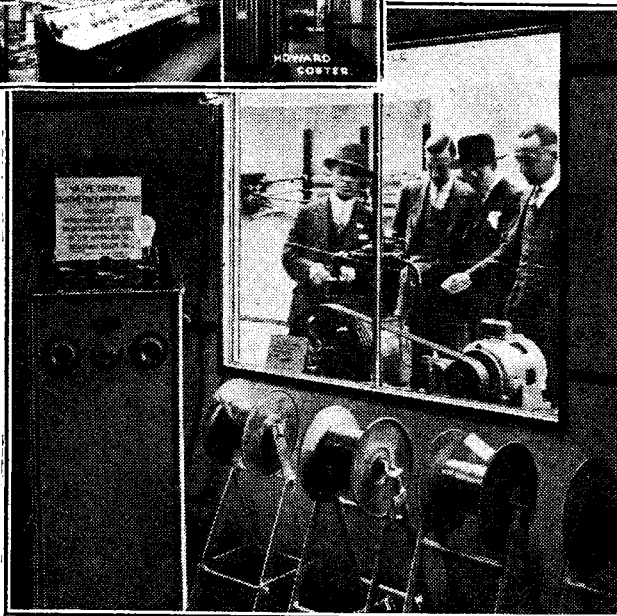

"side-shows." Even more effectively than last year the Post Office is showing the ordinary listener how he can rid his reception of this bugbear while respecting the interests of the man with the offending apparatus. Sound advice is available for all who suspect that their electrical appliances may be causing trouble, and one of

the most striking exhibits is a screened room housing radio-therapy gear. The walls have been sprayed with a zinc compound, and even the windows incorporate a wire mesh screen. The room is thus radiation-proof. The R.M.A., backing up the efforts of the Post Office, run a helpful Anti-Inter-

ference Bureau staffed by engineers of the Electrical Research Association, the B.B.C., Belling and Lee, Ltd., and other suppressor makers. A publication distributed free explains to the public in simple language the difference between heterodyne-interference, atmospherics, and electrical interference.

Letters to the Editor

The Editor does not hold himself responsible for the opinions of his correspondents

Electrical Interference

THANK you for the attention you are drawing to the present lack of legislation for the control of electrical interference.

For the past few years I have had to tolerate intermittent noise from a nearby lift which covers all wavebands. A partially successful effort to mitigate this nuisance has been made, but it is still there, even on my LF amplifier alone. Condensers my end help, but do not cure. But now a new devil has been raised which finishes any attempt to listen on a wide frequency band.

It does seem a queer state of affairs that permits anyone to destroy the pleasure of their neighbours at any time they desire. At the present time I am using some £60 worth of short-wave apparatus when I am permitted. If an amateur transmitter causes BCL interference, he will be duly decapitated. If I blow a motor horn after 11.30 p.m. or buy a cooking draught out of hours the utmost majesty of the law will be invoked against me with expensive consequences. But just let me buy a nice cheap electric motor and I may enjoy myself by blotting out reception locally, free of charge.

I trust that shortly steps may be taken to bring some help to sufferers from this irritating trouble. Continental nations, where incidentally radio is controlled by the Government, have got on with the job, but we have a committee. L. C.

Empire Broadcasting

IN your excellent paper you from time to time give correspondents an opportunity to ventilate their grievances, and to point out what, to them, is still lacking as regards information about wireless receivers generally. The greater interest now being taken in short-wave reception, which has been

precisely. Is it impossible to give sensitivity figures for a receiver tuning from 13-80 metres? or, are manufacturers afraid of the awful disclosures? *The Wireless World* would be doing its overseas readers a great service if it published a list of well-known SW receiver sensitivity figures, and would give as a standard for comparison the figure to be expected from a simple straight four-valver. The *Indian Radio Times* contains a plethora of advertisements for English and chiefly American SW receivers, ranging from 4-16 valves, straight sets and superhets, but, apart from the usual laudatory superlatives, there is nothing to indicate just how efficient the various instruments are. In spite of what has been said about the necessity for selectivity AVC, and other refinements, the thing that will sell one SW receiver in preference to another, in this part of the world at any rate, is its known greater over-all amplification or sensitivity.

Assam. W. F. WHALEY, M.D.

Accumulators for HT

WHILST appreciating Mr. Joughin's remarks regarding the design of battery-operated receivers, particularly in respect to their economic operation, may I point

out that there is a method of obtaining HT currents of 30 milliamps at a cheaper running cost and with a greater overall efficiency than by means of the lead HT accumulators?

Speaking purely from a technical standpoint, and omitting any trade interest which I might have, I regard the Milnes HT units as being the most economical and efficient means of running any battery receiver which calls for a constant drain of up to 30 milliamps, or with large Class B output receivers a momentary drain of 40 milliamps. I am referring now to the standard size Milnes HT units. There are larger-capacity models which will give even greater output currents. What is more, the overnight system of recharging the HT unit from LT accumulators ensures that the HT supply is always maintained at its maximum value, thus eliminating the loss of efficiency and deterioration of quality due to a partly discharged HT battery.

The running cost of such HT units varies slightly according to the local prices for charging accumulators. But at 6d. per 2-volt 60-ampere-hour cell a four-valve Class B receiver may be used for twelve hours per day at a total running cost of 1s. per week.

I should be pleased to give any of your readers who live in my district any advice they might require, free of charge or obligation of any kind, on this matter.

S. R. BRAZIER.

203, Acton Lane, W.4.

In Next Week's Issue

The Wireless World

COMPACT BATTERY TWO

A SPECIALISED receiver designed primarily for small yachts, but also suitable for use in other circumstances where ordinary facilities are not available, and where extreme compactness is desirable.

aerial, and the circuit arrangement employed gives an excellent range with only two valves.

LIST OF PARTS

After the particular make of component used in the original model, suitable alternative products are given in some instances.

- 1 Variable condenser, 0.0005 mfd. J.B. "Popular Log" 1038
(Formo, Polar, Utility)
- 1 Dial Claude Lyons—General Radio Type 703A
- 1 Variable condenser, 15 mufds. J.B. "Minor Midget"
(Eddystone)
- 1 Variable condenser, 0.0003 mfd., solid dielectric Polar "Compax"
(Graham Farish, J.B.)
- 2 Fixed condensers, 0.0001 mfd. T.C.C. "M."
- 1 Tubular condenser, 0.5 mfd. Bulgin PCP5
(Dubilier, Ferranti, Polar-N.S.F.)
- 1 LF Transformer Varley "Nictet," 1:3.5 ratio
(Ferranti, R.I.)
- 1 Coil, unscreened, iron-cored Wearite IC6
(Bulgin, Colvern, Goltone)
- 1 Rheostat, 10 ohms Kabi
- 1 Resistance, 250 ohms Dubilier
- 1 Resistance, 1 megohm Dubilier
(Amplion, Bryce, Eric, Ferranti, Graham Farish, Claude Lyons, Polar-N.S.F.)
- 1 Tapped Bias Potentiometer Eddystone 938
- 1 Three-point Switch Bulgin S13
- 1 2-way socket strip Bulgin P54
- 1 3-way socket strip Bulgin P6L
(Belling-Lee, Clix)
- 3 Knobs Bulgin K14
- 1 HF Choke Kinva Standard Type
(Goltone, Varley, Wearite)
- 1 Ammeter, 0-0.5 amp. Bulgin DM4
(Electradix)
- 2 Valve holders Bulgin VH26
- 1 Bicycle Lamp Battery, 3 volts Ever Ready 800
- 1 HT Battery, 60 volts Siemens Standard V.1
- 1 Pair Headphones, 2,000 ohms Ericsson
Wood, Sistoflex, Screws, Wander plugs, Wire, etc.
- Valves: 2 Hivac XL.

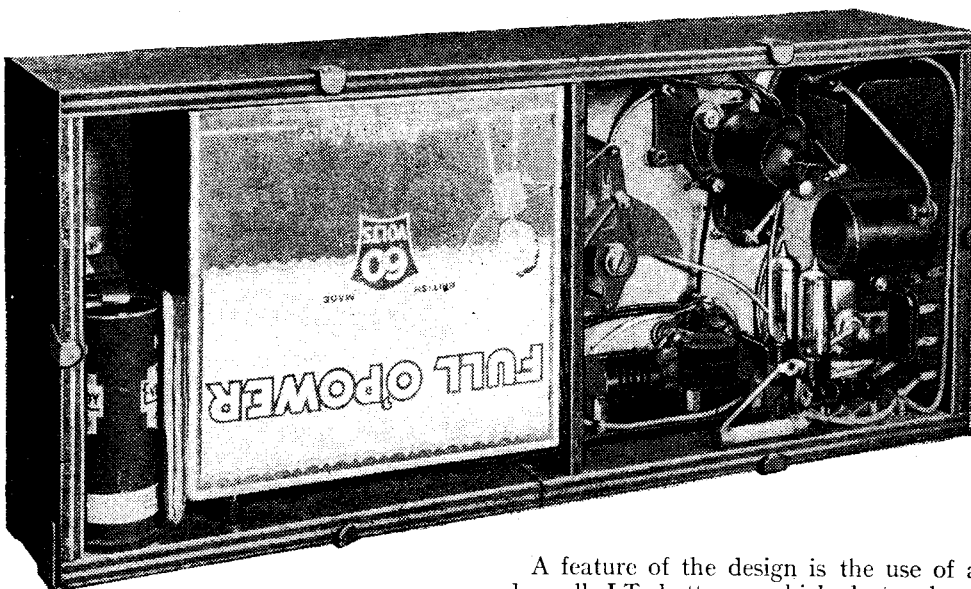

A feature of the design is the use of a dry-cell LT battery, which lasts about three weeks in normal use and can be replaced at a cost of 8d. The set, which is for headphone reception, is intended to work with a short (and often inefficient)

hosted by *The Wireless World*, prompts me to write and make the plea that the performance of short-wave receivers should be available for each type definitely and

The Wireless World

THE
PRACTICAL RADIO
JOURNAL
25th Year of Publication

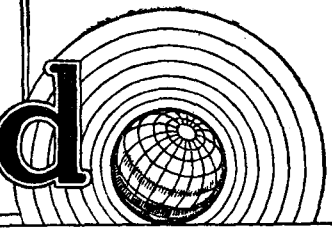
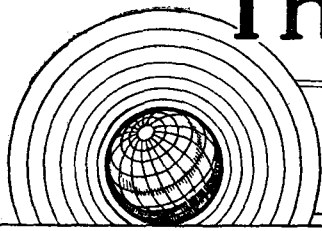

No. 835.

FRIDAY, AUGUST 30TH, 1935.

VOL. XXXVII.

No. 9.

Proprietors: ILIFFE & SONS LTD.

Editor:
HUGH S. POCOCK.

Editorial,
Advertising and Publishing Offices:
DORSET HOUSE, STAMFORD STREET,
LONDON, S.E.1.

Telephone: Hop 3333 (50 lines).
Telegrams: "Fthaworld, Sedist, London."

COVENTRY: Hertford Street.

Telegrams: "Autocar, Coventry." Telephone: 5210 Coventry.

BIRMINGHAM:

Guildhall Buildings, Navigation Street, 2.
Telegrams: "Autopress, Birmingham." Telephone: 2971 Midland (4 lines).

MANCHESTER: 260, Deansgate, 3.

Telegrams: "Iliffe, Manchester." Telephone: Blackfriars 4472 (4 lines).

GLASGOW: 26B, Renfield Street, C.2.

Telegrams: "Iliffe, Glasgow." Telephone: Central 4857.

PUBLISHED WEEKLY. ENTERED AS SECOND CLASS MATTER AT NEW YORK, N.Y.

Subscription Rates:

Home, £1 1s. 8d.; Canada, £1 1s. 8d.; other countries, £1 3s. 10d. per annum.

As many of the circuits and apparatus described in these pages are covered by patents, readers are advised, before making use of them, to satisfy themselves that they would not be infringing patents.

CONTENTS

	Page
<i>Editorial Comment</i>	241
<i>Compact Battery Two</i>	242
<i>Current Topics</i>	245
<i>Batteries or Mains?</i>	246
<i>Impressions of Olympia</i>	249
<i>Glasgow Radio Show Plan and Guide</i>	251
<i>Tone Compensation</i>	252
<i>Listeners' Guide for the Week</i>	256
<i>Burton AS5 Reviewed</i>	258
<i>Broadcast Brevities</i>	260
<i>Broadcasting in South America</i> ..	261
<i>Radio Data Charts—IX</i>	262
<i>Readers' Problems</i>	264

EDITORIAL COMMENT

The Room and the Speaker

Questions of Location

IN an article published in last week's issue the author discussed a number of points which should receive attention if a new set is to be given a really good start when it is first installed in the home. The advice was directed principally to purchasers of new receivers, but it could also be studied with profit by those whose business it is to install sets in purchasers' homes, and whilst some of the recommendations made may relate to points already familiar to them, we think we are correct in saying that the choice of the best location for the receiver in a room from the point of view of acoustics is a matter which has been very badly neglected.

It is possible to purchase a receiver capable of extremely good reproduction quality and yet ruin its performance by an unfortunate choice of location for the set in relation to the normal positions which would be occupied by those who listen to it.

The problem is scarcely one which can be solved theoretically in advance of setting down the set in a room. The furnishings, the general shape of the room, location of doors and windows, all have some bearing on the problem, and it is really only possible under normal home conditions to ascertain the right position by trial and error. Assuming that good quality and a satisfactory performance for the set is required by the owner, he, or she, should be prepared to go so far as to rearrange the room to suit the position of the wireless set rather than set it down in any vacant corner which looks as if it would do.

In general, the best position for the loud speaker will be found to be one where it is not near any walls or other surfaces which would tend to reflect the sound waves projected from the diaphragm. If the radiation from the loud speaker happens to impinge on a door, remarkable changes in conditions of reception in a room can be observed, depending on the angle of the door in relation to the speaker. The loud speaker should not be too near the listener, which reminds us once again of the desirability of separating the loud speaker from the receiver so that the best conditions of reception can be enjoyed whilst having the controls of the receiver conveniently placed for the listener to work.

Simplifying the Problem

At this year's Radio Show there were some examples of high-quality receivers where the speaker was designed as a separate unit, and the majority of set manufacturers to-day supply models where an extension loud speaker can be fitted to operate under conditions equal to the built-in speaker which itself can be shut off at will. It may take a long time to educate the public and to convince the manufacturers as to what is the ideal arrangement, but it seems fairly safe to prophesy that in the not-far-distant future separation of the speaker from the set in all high-quality wireless reproducers will be the rule and not the exception; when once this has been achieved, the problem of locating the speaker in the ideal position for the acoustics of the room will be far more easily and satisfactorily solved, for then the set can be placed without consideration of acoustics and bearing in mind only the convenience of the user. The accommodation of the loud speaker alone in the ideal position will then be a comparatively simple matter.

COMPACT

A Sturdy Receiver

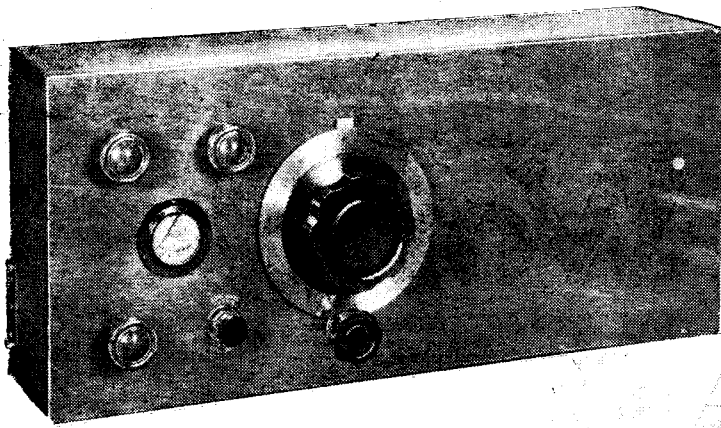

Thanks to the provision of a filament current meter on the front panel, the use of a dry LT battery becomes entirely practicable.

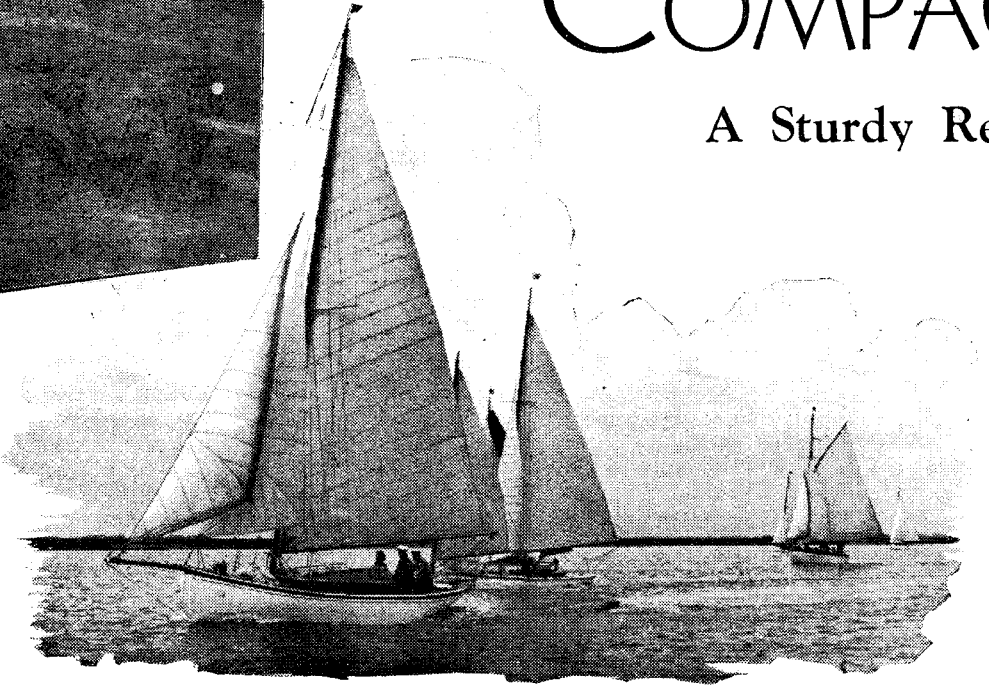

ALTHOUGH weather forecasts are not yet infallible the yachtsman who ventures to sea nowadays without a set capable of receiving them is taking unnecessary risks. The specialised set described in this article is planned firstly for small cabin boats, but has obviously many other applications

By "RADIOPIHARE"

IT is always a more interesting task for the wireless man to plan a specialised receiver than a domestic broadcast set, for the design of which there are many well-established conventions which cannot be ignored. For instance, there is not yet complete agreement as to the best type of receiver for a small yacht. Requirements for large yachts are almost the same as those prevailing on shore, but in small boats and particularly in sailing craft conditions are vastly different; lack of space, violent movement, and the need for extreme dependability and robustness all go to make up a set of conditions that do not exist elsewhere.

Of all the desirable features, dependability is probably the most important. A small yacht, tumbling about in a seaway, is no place for repairing a break in No. 47 wire! Still less is such a task to be relished if, anticipating bad weather and a pos-

sible change of plans, one is working against time to get ready for reception of a forecast.

All other things being equal, the simplest circuit will make up into the most reliable receiver, and that is why, after experience of much more complicated and ambitious circuits, the writer chose a detector LF arrangement for his own boat set. A two-valve single-circuit combination on these lines is just good enough for the job on the scores of sensitivity and selectivity. With regard to range, condi-

tions are so good on the water that even a few feet of aerial provides all the stations one needs, while restriction of aerial input combined with the judicious use of reaction helps to avoid interference in all ordinary circumstances.

With a large aerial interference would admittedly be rather a problem, and some slight alterations might be necessary. But, in the writer's experience, anything but the shortest of aerials is a nuisance; it is bound to get foul of the rigging, and in any case must be constantly taken down and set up again.

Thanks to the low filament consumption of the valves used, it becomes possible to use a dry-cell LT battery, which, it is submitted, is a great advantage. The accumulator and its recharging is a constant worry to the week-end boat-sailer. A standard type of bicycle lamp battery, on the other hand, is thrown away when exhausted; it is obtainable almost everywhere for 8d., and seems to last for about three weeks of ordinary steady use—possibly for half a season of week-ends. Voltage variations, the bugbear of dry-cell LT,

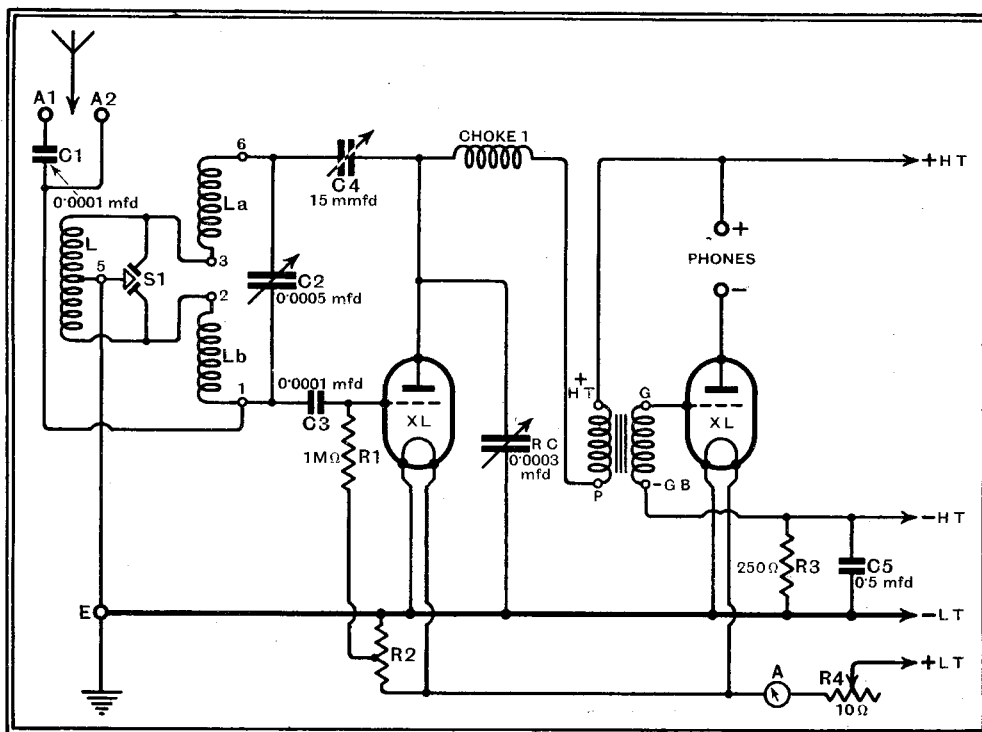

Complete circuit diagram. The medium-wave coil, which is interrupted at its centre point, comprises the windings La and Lb. The long-wave coil is marked L.

BATTERY TWO

Primarily for Use in Small Yachts

have been overcome by inserting in the filament circuit a cheap ammeter; this, in conjunction with a rheostat, enables the user to work the valves properly and also to know when the battery is due for replacement. The ammeter makes all the difference between practicability and impracticability of the dry-cell LT battery.

In Favour of Headphones

Another feature of the set is that it is arranged for reception by means of headphones instead of a loud speaker. This was done primarily to reduce weight and bulk and also because under many conditions headphone reception is preferable to that of a necessarily under-powered speaker. When one has become accustomed to the modern standard of quality, anything less good becomes annoying. Another point in favour of the 'phones is that the carrying power of sound over water in still air is extraordinary, and a loud speaker may disturb other users of an anchorage which would otherwise be a haven of peace and quiet.

As already implied, reaction control is

all-important in a set such as we are considering, and from this point of view our old friend the "throttle-controlled Hartley circuit" is hard to beat. In addition, it has the advantage that, if the set is used as a rough-and-ready direction finder with a frame aerial, the so-called vertical effect can be balanced out fairly accurately.

Referring to the accompanying diagram, reaction feed-back is controlled jointly by C4 and RC; the former is adjusted initially to the setting giving best results, and subsequent control is carried out by means of RC only. With the exception of the fixed grid potentiometer R2, which is provided in the interests of smooth reaction, and the resistance R3, across which grid bias for the LF valve is developed, the circuit does not call for comment.

With regard to construction, it seems much more important to reduce the back-to-front dimension than to go to extreme lengths to secure general compactness. If necessary, the set could be compressed into a container of even smaller dimensions than those shown in the lay-out and wiring plan.

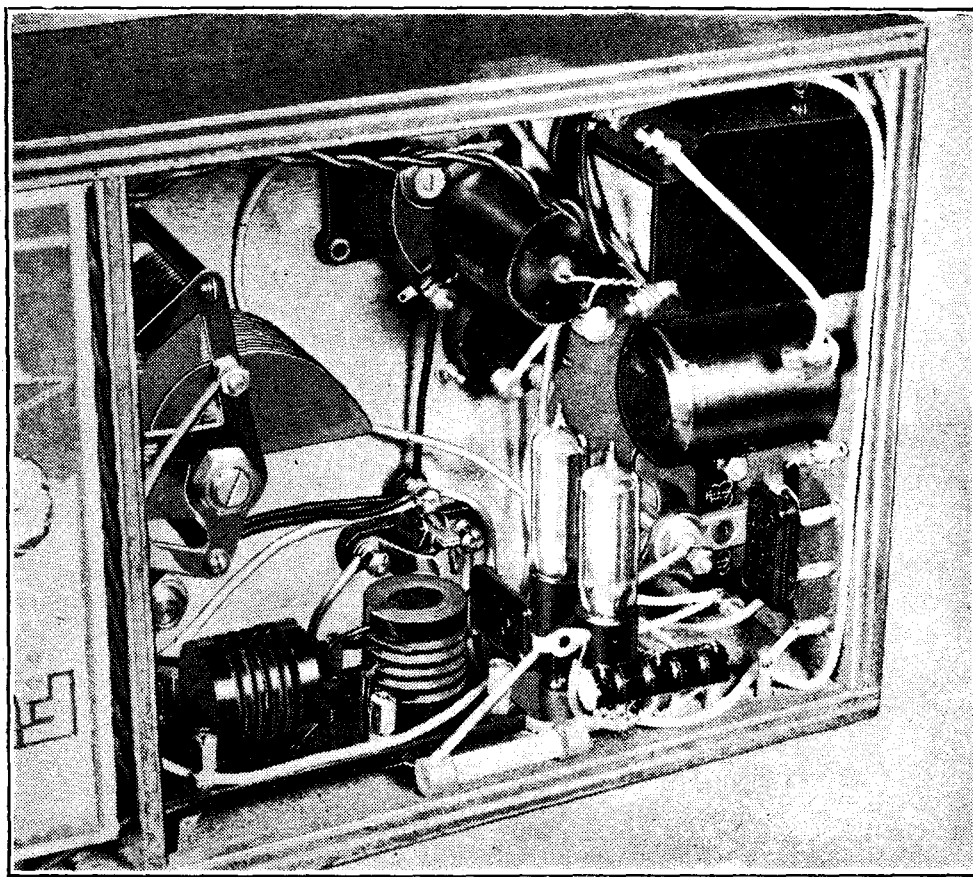

Although the receiver is compact there is no undue crowding of components. Note that the valve holders are raised on short distance-pieces.

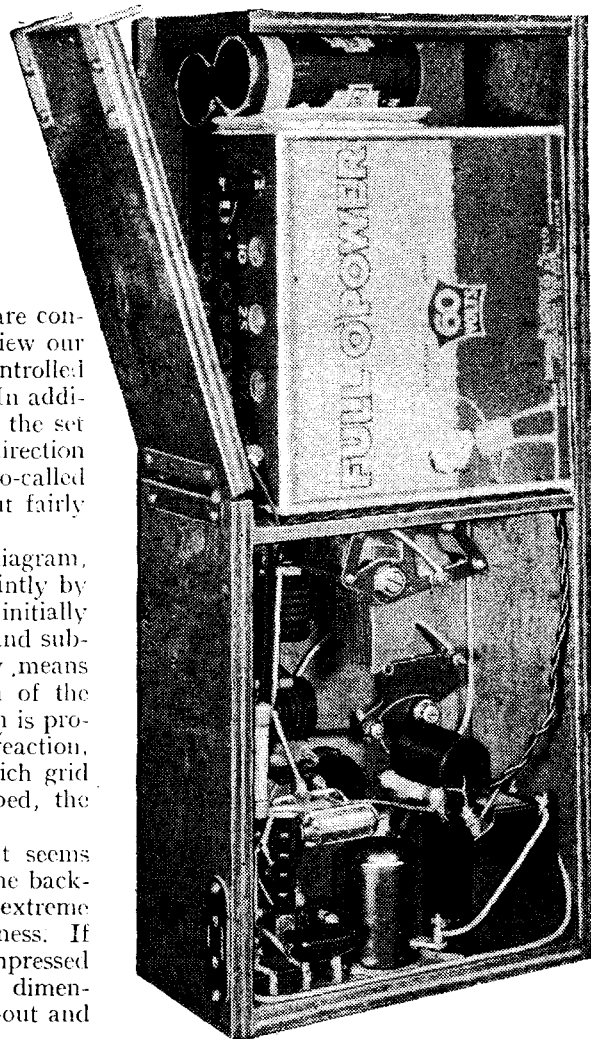

Showing the hinged flap which allows easy access to the LT battery for replacement.

It will be noticed in the accompanying illustration that space is provided in the case for a 60-volt HT battery and for the dry LT battery already mentioned. Matters are so arranged that the latter may be inserted after opening a hinged flap in the bottom of the case; the metal strips with which the battery is provided make contact with corresponding strips of springy brass suitably mounted on the back of the front panel and on the side panel; in fact, the principle is that employed in electric bicycle lamps of the type in which the battery is intended to be used. Connections between these spring contacts and the receiver section are made by strips of copper foil, protected by a covering of Empire cloth fixed by shellac varnish.

Shock-absorbing Mounting

The case itself is of simple design and can be made of $\frac{1}{4}$ in. plywood; gaboon (a kind of mahogany) is better than the usual soft wood and harmonises well with the average cabin fittings. The back may be extended half an inch or so at each end in order that it may be screwed to the bulkhead. Alternatively, a shock-absorbing mounting may be devised by drilling a hole through the projections at each corner and suspending the set by means of stout rubber bands passing through the

Compact Battery Two—

holes and round screw hooks in the bulk-head. This idea comes, of course, from the aeroplane receiver.

Ready-made coils for the circuit chosen are not available, but it is fortunately an easy matter to modify ordinary commercial dual-range coils. The Wearite coil used in the receiver illustrated is very simply altered by first disconnecting all wires and removing the two reaction

otherwise be taken as a guide to external connections.

It will be noticed that the condenser dial specified is of a type generally reserved for oscillators and other precision instruments, and its use in a comparatively simple set may appear to be an extravagance. The obvious retort is that nothing can be too good for one's "little ship"; there is also the technical consideration that no ordinary slow-motion dial is really

may therefore be earthed, and complete freedom from hand-capacity effects thus obtained. Failing a dial of this kind, it is better to use a plain one rather than an ordinary reduction-gear mechanism.

It should be remembered that the reaction condenser RC operates in the reverse sense to the ordinary control; reaction feedback is increased by *reducing* its capacity by anti-clockwise rotation of the knob. The initial procedure is to set

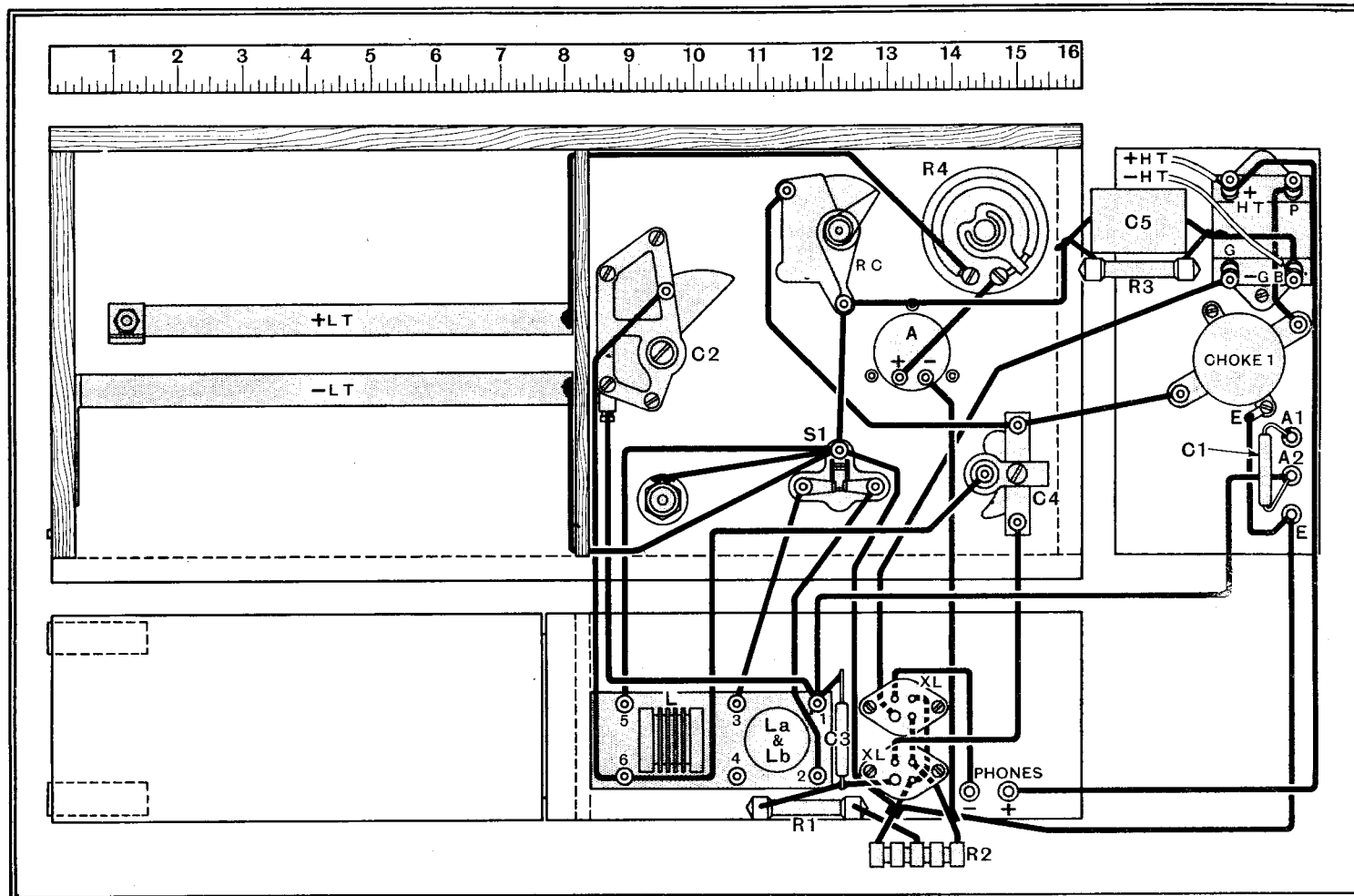

Practical wiring plan, with scale of inches for ascertaining dimensions and positions of components. Note that the bush of the slow-motion condenser drive knob (to the left of switch S1) is earthed. The inside back-to-front dimension of the cabinet is only $3\frac{1}{16}$ in.

windings. The medium-wave (litz wire) winding is then cut at its centre point, while a tapping is made to the centre point of the long-wave coils. The various ends and the tapping are finally connected to terminals numbered as in the circuit diagram; although this numbering is arbitrary, the practical wiring plan cannot

suitable for a Hartley circuit of which both sides are above earth potential, and so hand-capacity troubles will arise unless special precautions are taken. The dial used has a metal backing disc, insulated from the condenser spindle, through which the slow-motion drive is transmitted by a friction drive; the metal disc

C4 so that the vanes are about half enmeshed and then to rotate RC from maximum towards minimum capacity until the point of maximum sensitivity is reached. If there is any trace of backlash, an experimental reversal of connections to the ends of the potentiometer R2 should be tried.

LIST OF PARTS

After the particular make of component used in the original model, suitable alternative products are given in some instances.

- | | |
|--|---|
| 1 Variable condenser, 0.0005 mfd., C2
J.B. "Popular Log" 1038
(Formo, Polar, Utility) | 1 Resistance, 250 ohms, R4
Dubilier |
| 1 Dial, Claude Lyons.—General Radio Type 703A | † Resistance, 1 megohm, R1
Dubilier |
| 1 Variable condenser, 15 mmfds., C4
J.B. "Minor Midget"
(Eddystone) | (Amplion, Bryce, Eric, Ferranti, Graham Farish, Claude Lyons, Polar-N.S.F.) |
| 1 Variable condenser, 0.0003 mfd., solid dielectric, RC
Polar "Compax"
(Graham Farish, J.B.) | 1 Tapped Bias Potentiometer, R2
Eddystone 938 |
| 2 Fixed condensers, 0.0001 mfd., C1, C3
T.C.C. "M."
Bulgin PCP5 | 1 Three-point Switch, S1
Bulgin S13 |
| 1 Tubular condenser, 0.5 mfd., C5
(Dubilier, Ferranti, Polar-N.S.F.) | 1 2-way socket strip
Bulgin P54 |
| 1 LF Transformer, Varley "Niolet," 1:3.5 ratio
(Ferranti, R.L.) | 1 3-way socket strip
Bulgin P61 |
| 1 Coil, unscreened, iron-cored, L, La, Lb
(Bulgin, Colvern, Goltone) | 3 Knobs
Bulgin K14 |
| 1 Rheostat, 10 ohms
Kabi | 1 HF Choke
Kinva Standard Type
(Goltone, Varley, Wearite) |
| | 1 Ammeter, 0.05 amp.
Bulgin DM4
(Electradix) |
| | 2 Valve holders
Bulgin VH26 |
| | 1 Bicycle Lamp Battery, 3 volts
Ever Ready 800 |
| | 1 HT Battery, 60 volts
Siemens Standard V.1. |
| | 1 Pair Headphones, 2,000 ohms
Ericsson |
| | Wood, Sistoflex, Screws, Wander plugs, Wire, etc. |
| | Valves: 2 Hivac XL. |

COMMERCIAL ENQUIRIES

ENQUIRIES have been received from commercial organisations as to sources of supply of the following articles. Replies, which should be accompanied by the appropriate postage for home or foreign letters, and which should bear the appropriate reference number, will be forwarded by *The Wireless World* Editorial office.

C.E.8.—Modern A.C. sets in the 12-14 guinea class, with permanent-magnet loud speakers mounted externally to the receiver. (Home.)

C.E.9.—Aerial equipment generally, and particularly masts, insulators, guide arms, wire strainers, etc. (Home; for export.)

CURRENT TOPICS

R.M.A. and the Show

THAT the number of licensed listeners will reach 8,000,000 during the coming season is the view of the Radio Manufacturers' Association following the results of Radiolympia, 1935. It is estimated that of the 1,800,000 receivers represented by orders placed at the Show, 800,000 will go to homes which were previously without sets.

Curbing the Noisy Neighbour

THE possibility of a decree restricting the power of pri-

master-General is now considering the claim.

At the Open-Air Theatre

A UNIQUE public address system is being used at the Open-Air Theatre, Regent's Park, London, where Mr. Derek Farrar, of the Trix Company, controls from a screened cabinet a large number of microphones which are switched in and out to accord with the action of the players. Visitors to the Theatre will know that these methods actually assist towards making the audience forget that loud

Events of the Week in Brief Review

The Wireless World. During the War he was an instructor in the Wireless and Electrical School of the R.A.F. His exceptional gift for winning the affection of everyone around him was made patent during his long term with the Radio Research Board.

5-Metre Field Days

THREE mobile 5-metre stations, G2KI, G2VV and G6RS are to work in conjunction with a fixed station, G5VB, near Tattenham Corner, Epsom Downs, on Sunday, September 8th, when a field day will be held by the Thames Valley Amateur Radio Society.

Readers of *The Wireless World* who can take part or assist with reports are requested to communicate with the Hon. Secretary, Mr. James N. Roe (G2VV), 27, Baronsfield Road, St. Margarets-on-Thames.

On the following Sunday, September 15th, a 5-metre field day is to be held at Colney Heath by the Golders Green and Hendon Radio Society. All interested are asked to communicate with the Secretary, at 8, Denehurst Gardens, Hendon, N.W.4.

The Paris Show

TELEVISION will occupy a back seat at the Paris Radio Salon which is to be held at the Grand Palais from September

5th to the 15th next. The Organising Committee, in announcing the event, puts the public on its guard against "attempts by unscrupulous persons to dispose of apparatus alleged to be capable of receiving ordinary broadcast and television simultaneously."

Radio in the R.A.F.

FROM twelve to sixteen months' training as wireless operators, armourers and photographers will be given to 300 boys for whom vacancies will occur next month in the Royal Air Force. Entry is open to boys between 15½ and 17½ years of age on the 1st August and who have attended a secondary, junior technical or central school up to the age of 15½. Full particulars can be obtained from the Air Ministry (Boy Entrants Department), Adastral House, Kingsway, London, W.C.2.

The Empiric Receiver

AN error occurred in the description of the photograph of the Empiric Pocket receiver on page 219 of last week's issue. The model shown weighs only 31 ounces, and, although similar in some respects to the "police" type of wireless set, has been designed for use on broadcasting wavelengths.



"CONTROL ROOM," REGENT'S PARK. Mr. Derek Farrar maintaining his vigil during a performance in the Open-Air Theatre, Regent's Park. The elaborate public address system is referred to on this page.

vate radio receivers to an output of 2 watts is being considered by M. Langeron, Prefect of the Paris Police. A vigorous campaign supporting the scheme is being conducted by the *Paris Journal*.

Trolley Bus Interference

INTERFERENCE suppressors may soon be fitted to overhead trolley wires instead of to the vehicles themselves, following the success of experiments conducted last week in the presence of Ministry of Transport, B.B.C., P.O., and London Passenger Transport Board officials at Hampton Court.

The suppressors take the form of condensers to replace the heavy current choke coils at present mounted on the trolley buses. They will probably be fitted to standards at intervals of 200 yards along the road.

Broadcasting House for Marseilles

MARSEILLES, newly provided with a powerful regional station, is demanding a Broadcasting House equivalent to those in the leading capitals of Europe. The French Post-

speakers are in use, for the sound level remains remarkably constant.

Short-wave Stars

THREE interesting "galaxy of stars" programmes are being relayed during September by W2XAF (31.48 metres, 9,530 kc/s). On September 4th, at 7 p.m. (E.S.T.), Jessica Dragonette will sing with Rosario Bourdon and his celebrated orchestra. On September 11th at the same time the artist is Tito Guizar, accompanied by the International Orchestra. At 7 p.m. (E.S.T.) on September 18th the artist is Aida Doninelli.

The Late Mr. J. F. Herd

WITH deep regret we have to record the death from pneumonia, on July 22nd last, of Mr. James Fleming Herd, M.I.E.E., M.Inst.Rad.E., at the early age of forty-seven. Mr. Herd, who was Senior Scientific Officer in the Radio Department of the National Physical Laboratory, was a frequent contributor to our sister journal, *The Wireless Engineer*, and on a number of occasions his work appeared in



ANNOUNCERS ALL. Visitors to the Berlin Radio Show were permitted, after a simple voice test, to announce numbers given by the Radio Orchestra

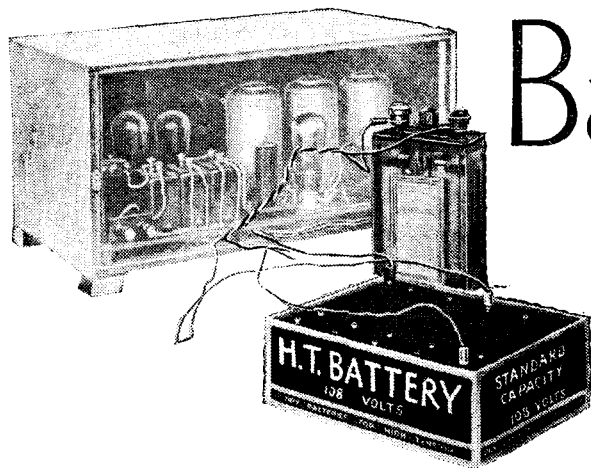

Battery or Mains?

By

M. G. SCROGGIE,

B.Sc., A.M.I.E.E.

TO the majority of those whom it concerns, the question of "Batteries or Mains" is very soon settled. Is there a mains supply available? If so, a mains set; if not, a battery set. All quite simple and no further argument needed.

The assumption, of course, is that a mains set is so immeasurably superior to a battery set that the question of having to choose does not arise; it is invariably decided by the force of one particular circumstance.

Readers who are not in the habit of taking things for granted whenever they can might care to go into the matter more thoroughly and sift the evidence in judicially impartial style. What follows is one attempt to do so.

The alternatives in question are methods of obtaining power for receivers so it is logical to judge them in terms of the unit of power taken over a period of time; the Board of Trade Unit, or kilowatt-hour or, to analyse it still more closely, the thousand-volt-ampere-hour. The price charged for this article by electricity supply companies and corporations varies astonishingly from place to place, but nowhere does it exceed 1s., and it may be as low as ½d.

High-tension battery power is not sold on this system, but is priced at so much per volt. The remaining factors of current and time are only dimly suggested by such additional data as "Triple Capacity" or "Amazing Life." So to make a direct comparison on a basis of B. of T. units it is necessary to carry out life tests on batteries. A typical present-day 120-volt HT battery selling for 7s. 6d., when tested under conditions similar to those of actual use until the voltage has dropped to about 70 per cent. of the starting figure, is found to cost something like £3 per unit—about 1,000 times as much as power from the "Grid."

This certainly seems to provide a devastating argument. And when all allowances have been made—and we shall find that there are a good many—nobody is likely to succeed in justifying batteries on a running-cost basis. But before accepting a comparison that by itself would be misleading, let us look at the extenuating circumstances.

First we have been talking about HT power only; LT power for battery-driven

sets is almost invariably derived from an accumulator cell, and even when the charging station has justified its name as much as its nerve and competition in the district permits, the cost per unit is much below £3; so the average for the whole set is reduced.

Next, whereas battery power is directly available for the set, mains power is partly dissipated in transformers, chokes and rectifiers. The cost "delivered to the door" may therefore be from 30 per cent. to 200 per cent. higher than that "ex-mains." In a DC or "universal" receiver, for example, a considerable proportion of the mains voltage usually has to be wasted before it is applied to the valve heaters.

Further, by adopting such devices as QPP or Class B, the battery set can be made to consume less current for maximum volume, and far less current for average volume; in other words, it makes much better use of the current it consumes.

HT Accumulators

These three considerations help to diminish the huge disproportionality of price. Then the "dry" HT battery is by no means the only sort to be had. We have already observed that power from accumulators is cheaper. What about the HT accumulator? There are some licencees whose answer to this question could be written only on sheets of water-cooled asbestos. There are others (who became vocal in the correspondence columns recently) who are as enthusiastic in its favour. The fact is that the HT accumulator is a good friend and a bad enemy. Sympathetically treated, it is the most perfect form of HT supply. But it is not likely to be so for general purposes.

Take as an example a typical 10-volt unit, for which the official recharging fee is 6d. Assuming that the full rated 5 ampere-hour capacity is used every time, the cost per unit is only 10s. The first cost and depreciation are heavy, however; and if these are worked out as a running cost the price per unit is considerably increased. On the other hand, if charging is done at home from the mains—and assuming due care and attention are lavished on the batteries—the cost of charging is far lower, not so very

COST OF HT CURRENT PER B.o.T. UNIT

From the Mains	½d. to 1s.
From HT Accumulators	10s.
From Dry Batteries	£3

WHAT our contributor describes as "sordid considerations of cost" must enter largely into any comparison between mains and battery sets. The figures he gives above seem to indicate that on this basis everything is in favour of the mains, but there are other factors, discussed in this article, which tend to even up the balance

much more than the cost of direct mains drive by the time it reaches the receiver proper; depreciation is reduced by home charging, and the inconvenience of cartage is eliminated. In favourable circumstances the cost handicap may be reduced to very close figures indeed.

An alternative is to hire HT accumulators. There seems to be considerable difference of opinion about the success of this scheme. Probably much depends on the nature of the particular hire service in the district. On the whole the indications are against this being the ultimate solution of the problem.

Still another form of HT battery is the Milnes unit. It is a nickel-cadmium-alkali accumulator, free from several of the less endearing traits of the usual lead-acid battery. Another special feature is the change-over switch enabling the charging to be done *in situ* from a somewhat augmented LT battery—6 volts instead of 2. The price of a couple of LT cells must therefore properly be allowed for in any estimate of costs. The whole scheme is really very cleverly worked out, and is not at all restricted to the more knowledgeable listener—quite otherwise, in fact.

Comparative Costs

Some idea of cost can be obtained by taking as an example a 120-volt "Minor" unit as recommended for a receiver drawing about 10 milliamps; the sort of duty to which the ordinary HT battery is put. Assuming an average of twenty hours per week in use, one cell is charged per week at a cost of, say, 6d. (official by Exide for the type of cell advised). The cost per B. of T. unit works out at one guinea. Per year the cost is £1 6s., and for the same from dry batteries, £3 15s. The difference, £2 9s., would pay for the extra equipment (£3 7s. 6d. for the Unit, 17s. for two extra cells, making £4 4s. 6d. in

CONSIDERATIONS OF COST AND PERFORMANCE

all) in less than two years. Under reasonable conditions of use the life is much longer than that of a lead HT accumulator; certainly longer than two years. And the voltage varies far less than in a dry-battery system. But that point comes later. The running cost, of course, can be far less if charging of LT or HT can be done at home from the mains.

Mains Equipment

In comparing these various battery alternatives we have already taken some account of the initial cost (which can always be reckoned over a period as an addition to the running cost). This is another item that whittles down the mains set's initial advantage in power cheapness. There are transformer, rectifier, smoothing chokes and condensers, for AC; the same less transformer and rectifier for DC, and less transformer but plus barretter, or its equivalent, for "universal." These items have cheapened amazingly since the mains set first appeared, and mass production of receivers has enabled the difference in cost between mains and battery-driven sets to become less and less. In the higher price classes it has become common for them to be priced the same, and recently the battery set has even been listed at a higher price!

There are several reasons for such an anomaly.

People who can afford the more expensive types of receiver or radio-gramophone can generally be counted upon to have electricity in the house. Consequently the higher the class of a receiver the more difficult it is to get one for battery drive,

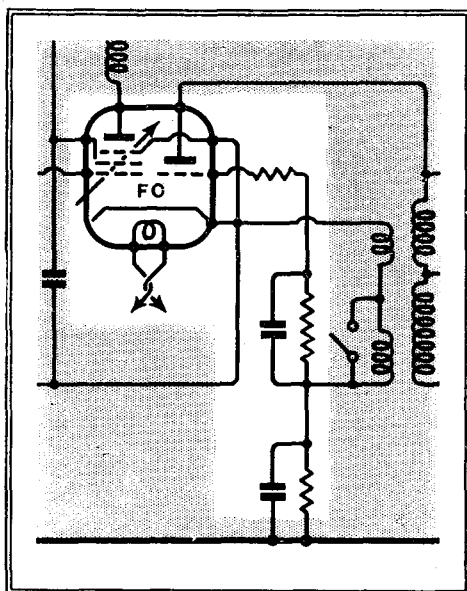

An advantage of the independent cathode; circuits of this kind are ruled out for battery valves.

the fewer the number produced, and the higher the cost of production. Manufacturers simply don't want to be bothered to turn out a hundred or two of battery models.

Again, such sets have to include a well-designed QPP, or Class "B" stage, which is considerably more expensive than a plain indirectly heated pentode. A high-class permanent-magnet loud speaker costs more than the energised version. Probably one or even two extra valves are required for comparable performance. All this goes a very long way to offset the cost of the "power pack."

But in the cheaper market it is quite different. The quantities are reversed—more sets are sold for batteries than for mains. The simpler battery valves are very cheap. The power pack in the mains version becomes a large proportion of the whole.

Initial cost (and valve replacement cost), then, cannot be definitely awarded to either battery or mains, but the former has the benefit of any balance.

Performance Factor

So far, it looks as if the predominant consideration has been the sordid one of cost. Turning to the more worthy considerations of performance, it is still difficult to avoid financial contamination. In order to prevent distortion, when reproducing at from good room volume upwards, it is essential to be able to handle plenty of power. Efficiency and high quality are still to some extent incompatible. If we want the very best reproduction we must be prepared to waste lots of power. Even at the maximum price per unit, power from the mains is cheap enough for us to be lavish with it. But batteries . . . each milliwatt is like a trickle of gold dust. Economy systems—QPP, etc.—can be good, very good, but never quite so good as systems that have oceans of power in which to splash about. Output, then, or quality, must be lumped with running cost as a mark to the good on the mains-drive side.

Now, at last for a point that is unequivocally in favour of batteries—hum. There is no need for hum to be a serious matter in a mains-driven set. It *can* be quite negligible. But to make it so demands considerable thought and expense, or luck. Besides ordinary or common hum there is modulation hum, and increasing amplification and short-wave coverage tend to make hum a problem, even if only an incidental problem.

Besides extensive smoothing, a mains-driven set requires decoupling. So does one driven by small dry batteries, but hardly to the same extent. And with an

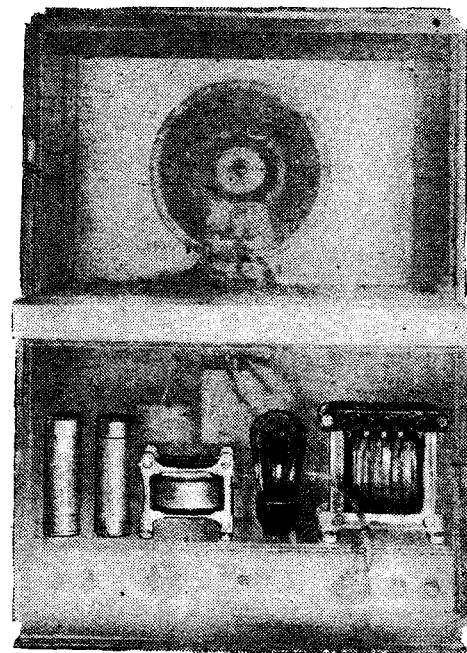

HT accumulator decoupling may be dispensed with altogether in most normal designs, so compensating at least in part for the lower voltage that considerations of cost enforce.

This is a point that especially favours HT accumulators to the disadvantage of mains. Almost exactly the reverse judgment must be passed on the next—the risk of destructive short-circuits. Unless the leads are very discreetly fused a short-circuit in an HT accumulator system may do grave damage to the expensive battery, and is almost certain to wreck anything, such as valve filaments, that constitute the "short." The same is true to a less extent with dry batteries. Mains valves, however, cannot be burnt out—except, possibly, DC valves if the series resistor is short-circuited—and a momentary flash is usually harmless to the power supply. There is, however, rather greater fire risk in a mains set, if a short-circuit persists.

Reliability

Regarding continuity of service, it is probably fair to say that far more listeners have been let down by batteries than by failure of the public supply. But whereas the former have a chance to study the Parable of the Foolish Virgins, kick themselves brutally, and vow good resolutions, the latter are stuck through no fault of their own; unpredictably, irremediably stuck.

It is to be regretted that there is one other crime of which certain supply authorities are guilty; namely, that of grossly exceeding the statutory tolerance in voltage variation. Less has been heard about this lately, and it is hoped that the gradual extension and consolidation of the "Grid" network will ultimately eliminate the trouble. Whereas a few are inconvenienced in this way by mains variations, all users of dry batteries have to put up with a continually dropping voltage; and as the maximum output from the power valve depends on the *square* of the HT voltage, the deterioration of results is

Battery or Mains? —

serious. A properly used lead accumulator is the most constant source, and the Milnes battery is not far behind it.

Considering now the reliability of the set itself, including valves, there can be no doubt that the battery-driven receiver wins. This is quite what one would expect. It has fewer components, and those components have fewer electrical and heat stresses to withstand. The same applies to the valves, with the possible exception that the filaments are more easily broken by mechanical shock than are the heaters of mains valves.

But for design purposes one would choose indirect heating every time. The unipotential cathode leads to better characteristics than does a filament that has to serve the double duty of cathode and heater, with a gradient of voltage along it. The advantage of a cathode that is independent of heater, and can be used for separate "automatic" bias, for coupling, and for other purposes, is increasingly felt in modern designs. And, of course, a 4-watt heater gives scope for higher mutual conductances than a 0.2 watt filament.

But if it is an advantage to have an independent cathode and heater, it is sometimes a deciding advantage to have a complete receiver independent of external connections. The portable set is not in the commanding position it once enjoyed, but sometimes there is no alternative. Here, then, is a field for battery sets. Small portable equipment, particularly for ultra-short waves, and with 'phones, or not-so-loud speakers, experimental or test oscillators; light, "go-everywhere" portables, receivers supplementary to the "concert grand"; here the consumption is so low that the dry-battery cost may be even lower than the distributed capital value of alternative mains equipment.

For the home receiver of modest output or for enthusiastic experimenters, even when mains are laid on, it may sometimes be possible to make out a good case for a Milnes battery or HT accumulator. But, after having examined every aspect of the case, it must be admitted that these are the exceptions and that the general rule with which our chapter opens still holds. Nevertheless, there *are* such things as exceptions, and there *are* a few points on which battery drive wins outright.

Random Radiations

By "DIALLIST"

A Sad Business

THE fire at the Berlin Radio Exhibition was a dreadful affair. The fire started at half-past eight in the evening when the halls were thronged with people, and but for the excellent safety precautions, which enabled the buildings to be closed with great rapidity, the loss of life might have been appalling, for many of them were constructed chiefly of wood.

The sympathy of all wireless folk will go out to the Germans, for they have worked so hard to make their 1935 Wireless Exhibition a great success, and before the conflagration the attendance had been well up to expectations. An enormous amount of valuable apparatus must have been lost, though salvage crews worked hard to rescue as much as possible. It is satisfactory to read that the greater part of the extensive television exhibit was saved. How the fire broke out is as yet a mystery, though a short circuit in one of the wooden buildings seems the most likely explanation.

A Short-wave Long Hop

THE engineers at the Berlin high definition television transmitting station, which has an experimental relay post in the Brocken mountains, have been surprised at receiving reports that both their sound and their vision transmissions have been well received in New York, a distance of over 3,500 miles. Berlin uses wavelengths in the neighbourhood of 6 metres, and this is, I believe, the first time that anything like such a distance has been spanned by ultra-short waves.

Readers may remember that a good many months ago I was bold enough to predict that, though their main service area was

of the quasi-optical order, ultra-short-wave transmissions might be found to reappear at enormous distances, the skip area being a very large one. This prophecy seems to have been borne out by the reception of Berlin in New York. It is too early yet to say that reappearances at long range will always occur, but the probabilities are that this will be so, the skip distance depending partly upon the actual wavelength used and partly upon the condition of the upper reflecting layers.

Television in Germany

THE high-definition television apparatus exhibited at the Berlin Show was very interesting for it embraced several different systems. No fewer than twenty receiving



SLOPE SPADES. The Labour Corps turned out to aid in salvaging radio sets from the fire at the Berlin Show.

sets for sound and vision were on view. The Fernseh Company, which is associated with the Baird system, showed both 320-line and 180-line images. Another system which attracted a good deal of attention is the Karolus, which is developed by the Telefunken Company. The German Post Office had an exhibit of 2-way sound and vision communication over telephone lines and kiosks, and it is announced that a regular service of this kind will be in operation between Berlin and Leipzig early next year.

I cannot help fearing that unless facilities for research are given to our manufacturers by means of experimental television transmissions there is some danger of an invasion by German products of markets that might be ours. German manufacturers have been able to go ahead right through the summer, and they have produced a considerable variety of double-channel receivers for which they are anxious to find markets outside, as well as inside, their own country. They might not be able to "dump" sets into this country, but they could possibly compete seriously with our own makers in other markets. It would be sad indeed if we allowed ourselves to be left in the lurch purely through apathy on the part of those who are responsible for the television services.

Berlin Gloats

THE German papers made a great deal of the fact that though a big section of the Berlin Radio Exhibition was devoted to television there was nothing in that line to be seen at Olympia. How right the German manufacturers were in giving prominence to television was shown by the huge attendances at the Berlin Radio Exhibition before the fire. I only wish that ours had seen matters in the same light, for public interest in this new department of wireless would have been enormous.

Nothing very ambitious would have been needed. A talkie film would have answered admirably for this purpose of giving simple explanations; you may remember the excellent talkie explaining the working of the Cathode Ray Tube that the N.P.L. staged last year. Then demonstrations on a small scale of low-definition and high-definition television would have given the audience an insight into matters that are still largely mysteries to the man-in-the-street.

Huizen Rings Down the Curtain

THE Dutch Broadcasting Authorities announce that the Huizen transmitting station is to be put right out of commission. Its voice will be heard no more, for the Kootwijk plant can be used for both the daytime 10-kilowatt transmissions and those with an output of 100 or more kilowatts, which begin at 7.40 in the evening. Listeners will be sorry that Huizen is to cease to exist, for in the past it has proved a most excellent standby, and one cannot help feeling a certain affection for so old a friend.

You have probably wondered why it is that the change-over from medium to high power takes place at so odd a time as twenty minutes to eight in the evening. The reason is that Holland does not adopt Greenwich time or Central European time. She has a time of her own which is 20 minutes ahead of ours. At 7.40 p.m. British time, then, it is 8 o'clock in the evening by Dutch time, the hour at which the chief programmes begin.

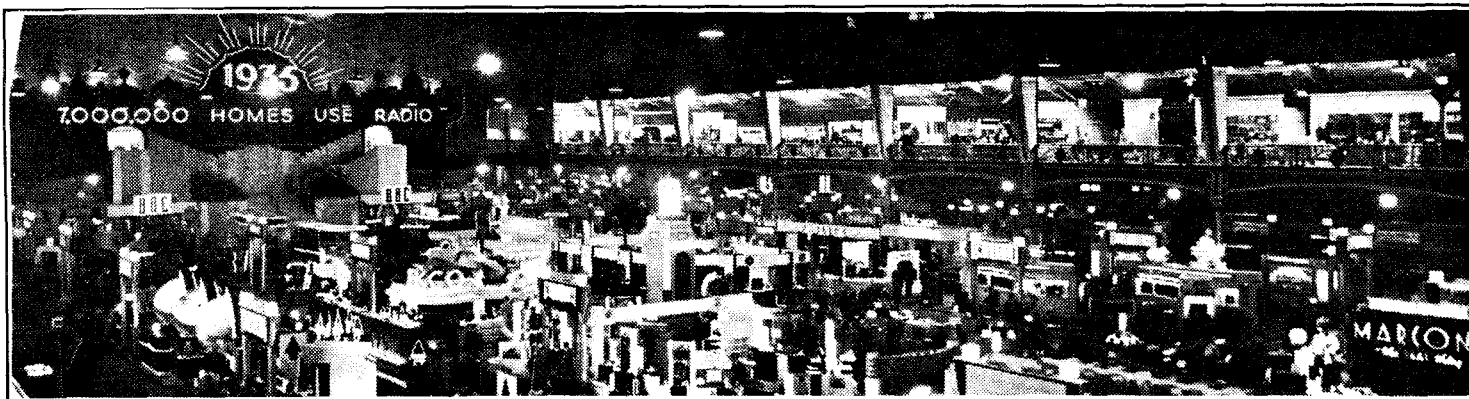

Impressions of Olympia

"Diallist's" Reflections on the Show

MY first impression as I stood just within the big entrance doors of Olympia was that the 1935 Exhibition looked, at a casual glance, not so very different from those of previous years. But the truth about the Exhibition is—to submit an old saying to 100 per cent. distortion—*plus c'est la même chose, plus ça change*. Stands covered with receiving sets, stands displaying valves, loud speakers, batteries and components, look very much the same at a distance as year follows year; but it was impossible to spend many minutes in a more detailed inspection without realising the vast progress that has been made in the past twelve months.

There are those to whom progress means reduced prices. If you're looking for cheaper sets than those of yesteryear your quest is likely to be a vain one. Prices have not come down and that, paradoxical as it may seem, is to my mind one of the best signs of progress. Last year we came perilously near the danger point in the matter of prices, and cut-throat competition this year would have been fatal. But if the price of sets has been very rightly maintained you get a great deal more for your money to-day than you did twelve months ago. Should you decide upon a set in the 11-guinea to 12-guinea class you will find that it contains many of the refinements which were regarded as luxuries and seen until recently only in much more expensive sets.

Reduction in Valves

One of the most remarkable achievements has been what may be termed the potting of the superhet. No so long ago the minimum number of valves in such sets was round about 7—H.F. (if you wanted selectivity plus sensitivity), combined first detector and oscillator, two I.F. stages, a second detector, a first L.F. stage and an output valve. Now the great majority of the moderately priced superhets achieve excellent results with but a trio of valves—purely wireless valves I mean, for I don't count the recti-

fier in mains sets. This has been made possible by the development of "port-manteau" or multi-electrode valves of highly efficient types. Thanks to them, the potted superhet of quite remarkable performance can be offered at a very modest price.

And these small superhets are far better than anything of the kind that we have seen before. A couple of years ago the lower priced sets of this kind were often without any kind of automatic volume control; even last year the automatic volume control used in the smaller sets was not always too effective in its action. Those of this year's vintage that I have tried show remarkable progress in this direction.

Reliable "Extras"

Then there's the visual tuning indicator, which is so much to be desired in the superhet intended for operation by the man in the street and his better half. This year it is not confined to the luxury sets. My one fear is that the general excellence of sets priced between 11 guineas and 12 guineas may possibly lead a large section of the public to form the fixed idea that such prices are as much as anyone should pay for his or her receiving set, no matter how healthy the state of the bank balance. It was this kind of thing that led to the virtual disappearance of high-tension batteries of large capacity, with rather tragic effects upon the design of receivers for battery operation; you will find few battery superhets offered to-day and though it is definitely possible to make battery sets capable of a very respectable undistorted output, the great majority are now designed largely to achieve economy in high-tension current.

It would be sad indeed if the bigger and more costly set for mains operation were elbowed out by the cheaper models. I don't think that there is much chance of this, for though there are many who will always buy what is cheapest, there are also many who have come to realise that in wireless, as in so many other

things, you get exactly what you pay for.

Apart from radio-grams this year's luxury sets, even in all-wave form, seldom run to much beyond 20 guineas. But many of them are beautiful things, well worth every penny of the extra cost. They contain refinements (and what a difference refinements make!) that you cannot possibly expect to have in less costly apparatus. One of the most delightful of these is variable selectivity. Last year, when the Lucerne Wavelength Plan had not outgrown the troubles of infancy, the great demand was for selectivity at almost any price. The price was apt to be rather a heavy one, resulting in "woofy" reproduction containing very little of the higher frequencies. At one time it seemed that there might be no choice between the high-quality receiving set, confined almost entirely to the local programmes, and the ultra-selective receiver which enabled dozens of foreign stations to be received with indifferent quality.

Variable selectivity, which, so to speak, enables you to cut your top according to your heterodynes, is a neat and effective solution of the problem. Both local and distant stations become receivable at their very best.

Other Refinements

Next there is suppression of noises in between stations by means of quiescent automatic volume control or the squelch-valve circuit. You are not bothered as you pass from station to station with squeaks and whimpers (or worse things than that) from the smaller fry, whose field strength is insufficient to make good reproduction possible. They are just blotted out and all is well. It is, though, desirable that there should be some means of putting the controlling circuit out of action when required; otherwise the set would not be usable for that picking up of weak and distant stations in which not a few of us indulge at times.

To me the all-wave set is the ideal form of radio receiver. Though most of us

Impressions of Olympia—

derive the bulk of our wireless entertainment from the home stations, listeners have shown in no uncertain manner that they want to be able to reach out farther afield on occasion. Nearly every set to-day is, in fact, a long-distance receiver. Its interest and its usefulness are enormously increased if by the mere movement of a switch you can change over to one or other of the short-wave bands. All-wave sets were to be seen here, there and everywhere at Olympia, and I was very much struck by the design and appearance of many of them.

Comparison with U.S.A.

It is rather curious that, apart from radio-grams, there are no receiving sets of the really big class—sets, I mean, with from ten to fifteen valves, such as are widely used in the United States. I cannot help feeling that there would be a considerable demand for these. It might be a little time before they caught on, but once people had begun to see what amazing results could be obtained by the liberal use of valves they would soon become more and more popular. There is already a notable demand for the largest kind of radio-grams, costing about £100, with automatic record changing and all kinds of other luxuries. Would there not be a still bigger demand for the purely wireless set of many valves, which could probably be sold at somewhere between £30 and £50?

Television

I was sorry to find no composite television exhibit at Olympia, though some time ago a kind of half-promise was made that there would be one. I can't help thinking that such an exhibit would have been useful in many ways. The history of television has perhaps been a little unfortunate in this country. Again and again during the past eight or nine years the public has been told that television was an accomplished fact; again and again it has found that there was many a slip 'twixt cup and lip. High definition television is an accomplished fact—it has been so for more than a year now. Demonstrations in a small theatre would have prevented enthusiasm from evaporating, and they might have provided an admirable opportunity for driving home in a practical way the oft repeated warning that the television set cannot possibly replace the "broadcast" receiver for many a year to come.

On the whole, a most satisfactory Exhibition, mercifully almost free from those stunts which in some past years have promised to "revolutionise radio" without in fact achieving anything revolutionary. Quiet, steady progress is the keynote of this year's manufacturing programmes, and quiet, steady progress is a whole lot more valuable than irresponsible leaps and bounds.

Athlone to Relay America

Big Broadcast Changes in Ireland

(By Our Dublin Correspondent)

REOrganisation of the Irish Free State system of broadcasting is now in progress under the guidance of Dr. T. J. Kiernan, the new director, and is on such a big scale that the transition period will not be completed till nearly the end of this year.

Negotiations are proceeding between the Free State authorities and the authorities of several European countries with a view to an exchange of programmes. Several satisfactory replies have been received, and it is expected that by October an experiment in this will be made for the first time in the Free State.



Dr. T. J. Kiernan, late Irish Free State Commissioner in London, who is now in charge of Irish broadcasting. Important changes are already taking place in programmes and administration.

The second plan of the new Director is to establish a short-wave receiving station to permit of the relay from Athlone of important American and foreign programmes. For this purpose a site is being sought by the engineers of the Department of Posts and Telegraphs outside Dublin. Reception at the General Post Office, where the Free State studios are, would be unsuccessful, and I understand that it is very likely that a site will be chosen in the Phoenix Park.

The Free State is making a determined effort to deal with the problem which faces all radio authorities, viz., the development of radio drama. Technical advice will be given by the Free State authorities on dramatic material under the direction of Mr. John MacDonagh, who has been appointed Production Director of the station.

The hope is that by co-operation between the Irish stations and writers a

technique will be evolved. Every encouragement will be given to enable original productions, in Irish and other languages, to be broadcast.

Prizes for Humour

Another interesting development, to come off here soon—in fact it is practically revolutionary—is the production of plays by the station itself instead of, as has been the practice in the past, relying on contributors. For this a register of players will be prepared and auditions will be given to new players in an effort to find fresh talent.

Registers will also be made of singers and instrumentalists who will be examined and graded according to merit and seniority. Authors will be invited to submit plays, sketches, dialogues, and monologues in Irish and English. The formation of a Radio Committee in Galway has proved to be very successful; they have already enrolled members in five counties and are arranging for a series of broadcasts. The tendency is to reduce the number of broadcasts by Irish traditional players, and to replace dull lessons in Irish and foreign languages by sketches, plays, stories and lectures of a bright and interesting character.

It is probable that portable wireless sets will be used more and more in running commentaries on sporting events. The practice of the B.B.C. in getting prominent visitors to London to give their views of England is being followed in Dublin and many English and American visitors have already spoken on the radio.

One of the problems set the Director is to find good humorous characters for talks. Prizes are to be offered in order to lure native humour to the microphone.

The news service has also been improved, and instead of long rigmaroles of official announcements we have "snappy" items which delight the heart of the sub-editor. In short, the Athlone Station is in the process of its biggest change, a process which will take at least twelve months to complete. And it is all being done with something like £2,000 extra from the licence funds.

Berlin Radio Show

Next week's issue will contain a fully illustrated review of the most interesting features seen by our representative who visited the Show



To-day, August 30th, the Radio Show opens at Glasgow, having moved on from Olympia. It is, of course, the same display as far as the exhibits are concerned, and our Olympia Show numbers can equally be regarded as a guide to what to see at Glasgow. The Exhibition is open daily from 2 to 10 p.m., except on August 31st, September 4th and 7th, when doors open at 11.30 a.m.

	Stand No.
AERODYNE Radio, Ltd	27
Allied Music Traders, Ltd.	34 & 68
BALCOMBE , Ltd., A. J.	44
Ballantine, Robert	7
Beethoven Radio, Ltd.	50
Belling & Lee, Ltd.	13
Biggar, Ltd., Alexander	25
Black, Ltd., Michael	37
Blackadder, William	71
Britannia Batteries, Ltd.	11
British Broadcasting Corporation	<i>Special Exhibit</i>
British "Wireless for the Blind Fund"	49
"Broadcaster & Wireless Retailer"	77
Buchanan, Garnet R.	20
Burndept, Ltd.	36
CHLORIDE Electrical Storage Co., Ltd.	47
City Accumulator Co., Ltd.	1
Clarke & Co. (M/c), Ltd., H.	45
Clydesdale Supply Co. (1922) Ltd.	41
Cole, Ltd., E. K.	29
Columbia Gramophone Co., Ltd.	62
Cossor, Ltd., A. C.	31
Cuthbertson & Co., Ltd.	73
DECCA Gramophone Co., Ltd.	26
Denholm, J. Stuart	39
Dulcetto-Polyphon, Ltd.	3
" ECONASIGN " Co., Ltd.	14
Edison Swan Electric Co., Ltd.	52
Eddystone Radio	69
Elder, Ltd., David	26
Ever Ready Co. (Gt. Britain), Ltd.	35
Ewing & McIntosh, Ltd.	42

List of Exhibitors

	Stand No.
FERRANTI , Ltd.	60
GENERAL Electric Co., Ltd.	28
Gow & Sons, J.	66
HARPER & Co., Wm.	18
Hartley Turner Radio, Ltd.	48
Hellesens, Ltd.	5
High Vacuum Valve Co., Ltd.	24
His Master's Voice (The Gramophone Co., Ltd.)	51
Houghtons the Wholesalers (Ensign, Ltd.)	58
Hunter, James R.	6
ITONIA , Ltd.	55
JOHNSON Talking Machine Co., Ltd.	8
KOLSTER-Brandes , Ltd.	67
LAMPEX Radio	54
Lissen, Ltd.	33
McMICHAEL Radio, Ltd.	61
Machell & Son, Thomas	16
Marconiphone Co., Ltd.	30
Methven, Simpson	34 & 68
Muir & Bryden	38
Mullard Wireless Service Co., Ltd.	59
Munn's Radio Service	57
NORTH British Machine Co., Ltd.	56

	Stand No.
OLDHAM & Son, Ltd.	76
PATERSON'S	34 & 68
Philips Lamps, Ltd.	53
Post Office	<i>Special Exhibit</i>
Pye Radio, Ltd.	32
RADIO Gramophone Development Co., Ltd.	2
The Rapid Radio Co.	49
Robertson, James	46
Ross & Adam	74
SCOTTISH Radio Retailers' Association	70
Siemens Electric Lamps & Supplies, Ltd.	78
S.R.R.S. Co.	64
Steele, Ltd., W. S.	21
Stirling Hunter, Ltd.	75
Stratton & Co., Ltd.	69
Thompson, Diamond & Butcher	15
Thomson & Brown Bros., Ltd.	17
Tideman, C. G.	63
ULTRA Electric, Ltd.	43
VICS Radio, Ltd.	40
WATERHOUSE , Ltd., Frederick	72
Westinghouse Brake & Signal Co., Ltd.	9
Whiteford & Co., James	12
Whiteley Electrical Radio Co., Ltd.	10
"Wireless & Gramophone Trader"	22
"Wireless for Hospitals" Fund	79 & 79a
Woolfson, Ltd., Philip	19
YOUNGS' (Glasgow), Ltd.	4

Tone Compensation

A Discussion of Its Merits

By M. G. SCROGGIE, B.Sc., A.M.I.E.E.

TONE Compensation cannot be treated as a simple fitment to the modern receiver which will correct for variations in intensity at all frequencies in such proportions as to maintain correct relative loudness. This article discusses some of the difficulties which have to be taken into account.

LISTENERS of discrimination have no difficulty in noticing, even if the best "straight-line" high-power reproducer is employed, that when the volume level is altered there is a considerable difference in the lifelikeness of the result, and that this difference is not solely one of volume. When the output is reduced by means of the usual volume control so as to be acceptable to an afternoon tea-party in a small room, the proportions of low, middle, and high tones from the loud speaker are exactly the same as when it is turning out as much as a real band at close quarters. Yet the balance of tone does not sound the same; it sounds deficient in bass.

This is quite a well-known effect, for which the peculiarities of the human ear are responsible. The quality-enthusiast may do what he pleases to make his apparatus treat all frequencies alike, but his ear is a link in the chain that he can neither control nor leave out of account. Common experience is fully confirmed by scientific measurements, which show that the ear is much less sensitive to low than to middle and upper middle tones, and that the difference becomes more marked as the volume diminishes.

It is seldom desirable to have programmes reproduced in one's home at the same volume as the original. It is even less desirable to have them reproduced at

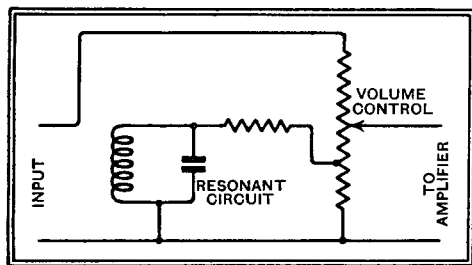

Fig. 1.—Circuit of a simple type of tone-compensated volume control.

life-size strength in the next-door neighbour's house or garden. So, assuming the considerable reduction in scale imposed by social amenity (not to speak of the output stage of the receiver), attempts are sometimes made to restore the balance of tone by means of a tone-compensated volume control.

A Representative Circuit

An example of this in a radio-gramophone that is regarded as the last word in refinement is the circuit arrangement shown in Fig. 1. A parallel resonant circuit tuned to about 50 cycles per second is tapped across the lower

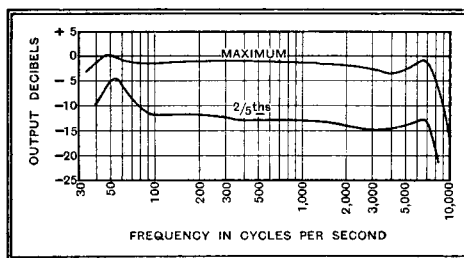
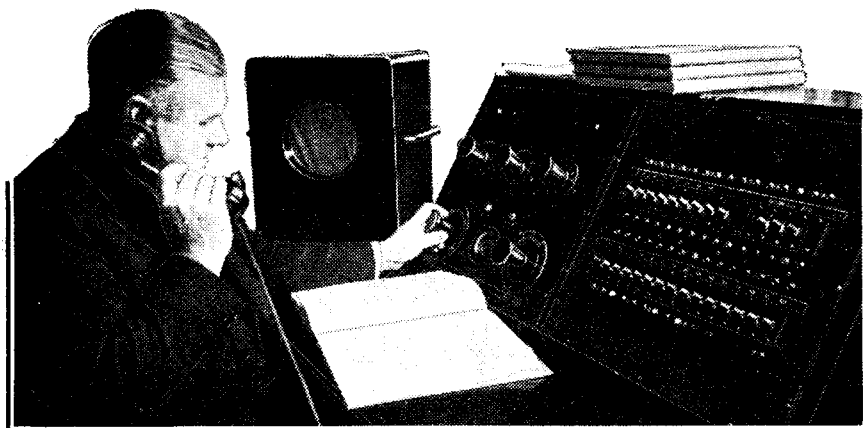

Fig. 2.—Characteristics of simple tone-compensated volume control, showing effectiveness of bass reinforcement.

portion of the volume control. When the control is set to maximum this circuit has a negligible effect on the balance of tone; but as the slider is moved towards the tapping there is an increasing tendency for the impedance at 50 cycles and thereabouts to be greater than at higher frequencies. Consequently the bass notes are lifted above the rest. Below the tapping there is no further modification. Fig. 2 shows the frequency characteristics with the volume control set at maximum and at two-fifths.

A disadvantage of this and similar systems is that the volume corresponding to any specified setting of the volume



The only true basis for compensation begins at the transmitter. The B.B.C. control engineer can spoil any efforts at tone compensation which the listener may make at the receiver end.

control depends on such things as the strength of the particular station being received, the average depth of modulation thereof, or the sensitivity of the gramophone pick-up. It might happen, for example, that full volume could be obtained with the control set at two-fifths, giving full compensation when actually none should be needed according to the intention of the designer.

Such, at any rate, is the criticism offered by the American Hazeltine concern, which has presented an ingenious alternative under the name of A.B.C.; meaning Automatic Bass Compensation. This development may necessitate a reconsideration of the expression "As simple as A B C," for it includes an extra pentode and a double-diode-triode, and the suggested circuit diagram shows seven valves from the first LF onwards, exclusive of power rectifier. Reduced to skeleton form, the circuit of the system is as in Fig. 3, and the performance characteristics are shown in Fig. 4.

How the Circuit Works

It is not difficult to follow the action; in addition to the normal amplification chain from detector to output transformer there is an auxiliary chain giving a bass tone amplification considerably greater than the other, so that if it is allowed to function to the full extent of its ability the flat frequency characteristic receives a very decided boost at the low end. When the volume at the output transformer is large, the voltage available therefrom is rectified by the diode section of the second A.B.C. valve and applied through a suitable filter to the grid of the first valve, which has variable-mu characteristics, and which therefore shuts down in proportion to the volume. The bass boost is thus taken off when the volume is full, and applied when it is at a reduced level. A potential divider and switch at the grid of the second valve enables the action of the A.B.C. to be reduced or cut out altogether.

Tone Compensation—

In return for two extra valves—not of the simplest kind—and a few dozen components, one may reasonably look for a considerable degree of refinement and perfection in the results. To judge of this it is interesting to compare Fig. 4 with Fig. 5, which shows the intensity of sound required to produce sensations of equal loudness over the whole frequency scale. The scale on the left-hand side gives the relative intensities of sound as measured by the amount of alternating pressure set up in the air. The right-hand scale measures the loudness of the sound when judged by a normal ear. The lowest line, marked 0, joins all points where sound is only just audible. From this it can be seen that the ear is most sensitive at about 2,000 cycles per second, at which a sound 95 decibels below the arbitrary zero can be detected. A sound of 32 cycles per second requires to be no less than 70 decibels stronger than this to be just heard. The other lines similarly join all points corresponding to sounds 10, 20, 30, etc., db louder than just audible. A clear distinction must be made between strength (or intensity) and loudness of sound. However intense a sound may be, it cannot be loud to a man who is stone deaf. And even to a normal ear a

sound of a certain intensity may be loud, soft, or inaudible, according to its frequency. For example, a sound of -40 db. is inaudible at 32 cycles per second, is very faint indeed (about 5 db. above

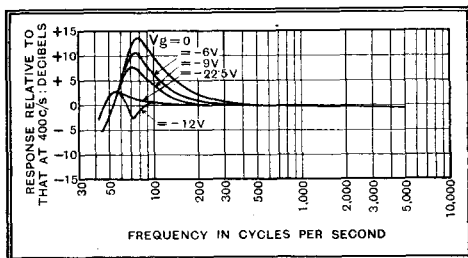

Fig. 4.—Characteristics of automatic bass compensation. The V_g figures are the controlling grid bias to the first A.B.C. valve derived by rectifying the signal potentials obtained from the output stage.

threshold) at 64, and is well over 50 db. at 3,000. Fifty decibels corresponds to ordinary conversational strength. Loud radio may be 70 db., and when turned down to sleeping baby volume is in the region of 35 or 40.

Comparing this diagram, Fig. 5, with that of Fig. 4, we find that the latter makes no provision for the loss of high tones. However, this loss, between the 40 and 70 db. loudness lines on the dia-

gram, is not very large, and is so high up the scale as to be out of the bands usually fixed for a selective receiver. Below 70 c/s there is a very rapid fall, so evidently this part of the scale also is disregarded; again a matter of commercial expediency. The rising bass is a good deal more sharply peaked than would seem desirable from the curves of Fig. 5, which show the rise beginning from 2,000 or 3,000 c/s. The reason given for this is to retain naturalness in speech reproduction—a point that will be considered later. But where the cure seems to be least appropriate to the alleged disease is in the rate at which it is applied. V_g is the grid bias on the first A.B.C. valve, and is proportional to the output to the loud speaker. As V_g drops to one-half, from 12 to 6 volts, a matter of 6 db., nearly the whole of the compensation comes into action. The remaining drop, from 6 to zero, an infinite number of db., evokes a negligible further amount of compensation.

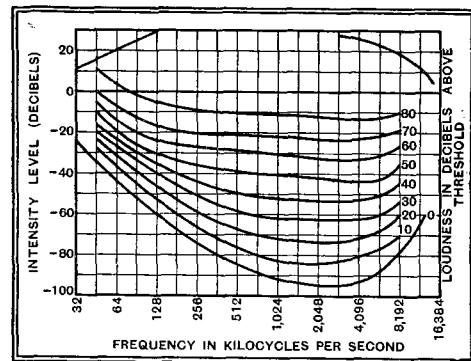

Fig. 5.—Diagram showing the intensities of sound required to give various degrees of loudness judged by a normal ear.

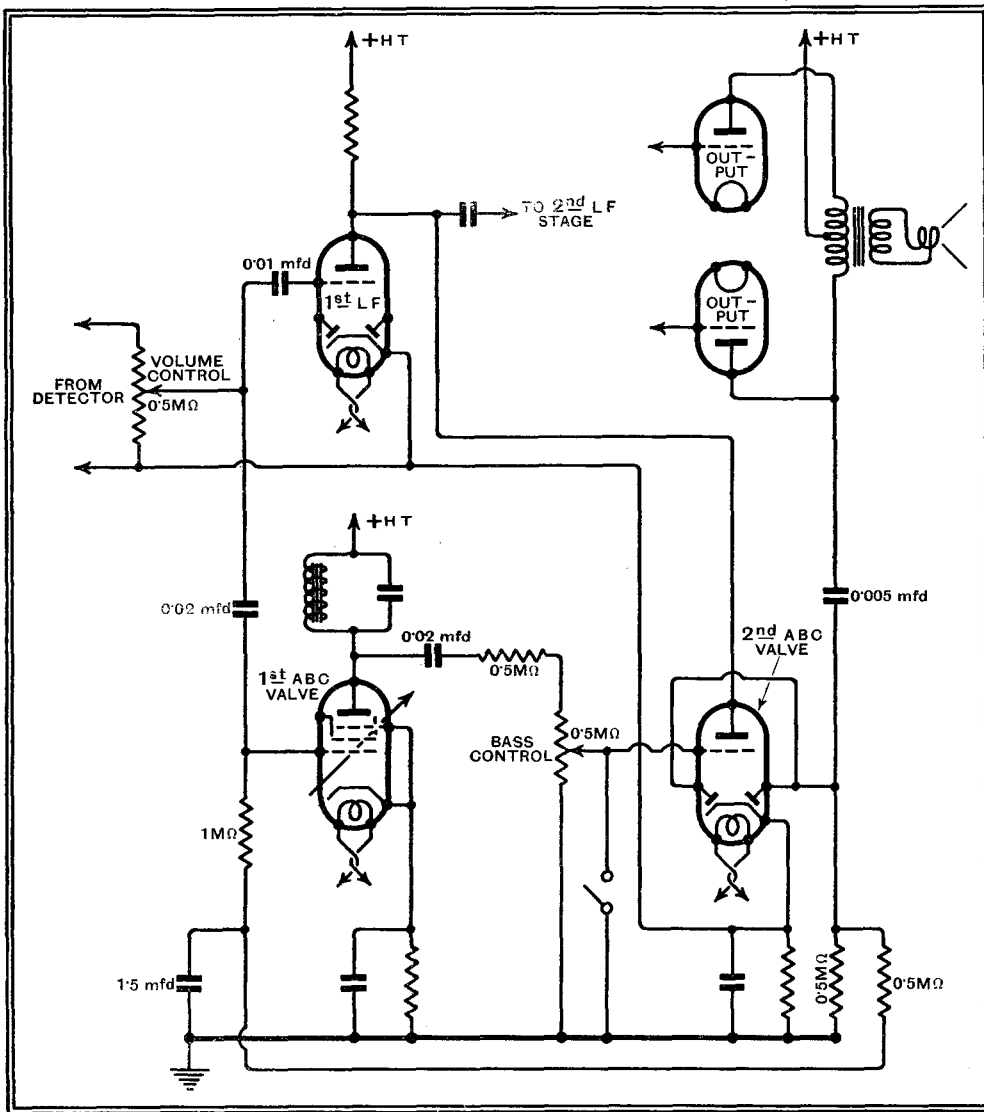

Fig. 3.—Skeleton circuit diagram of an "automatic bass compensation" system. The two lower valves are the additional ones required.

One of the advantages put forward for A.B.C. against tone compensation of the simple volume-control sort is that it takes into account the variations in musical amplitude from *ff* to *pp*. Considering this; suppose we have reached a fortissimo in the music which presumably requires something like the full output of the set to reproduce, and consequently the bass lift is automatically absent. Assuming perfection throughout the apparatus, we are listening to a perfect rendering of the original. But it is too loud for our suburban lounge and we turn down the volume. The output declines and the low tones *would* decline out of due proportion if it were not for the action of A.B.C. in bringing reinforcements. So far, according to plan.

But if we are among the social menaces who must have the music life-size in the interests of realism, we leave the volume control "flat out." In due course the outburst subsides into low orchestral mutterings, *pp*, and the output voltage drops, bringing the bass boost into action. Why? If one were listening to the music direct, would one desire the conductor to give special attention to his bass instruments to make up for the deficiencies of hearing? Surely that has already been attended to instinctively; and as the music, though now weak, is still as loud as the original—

Tone Compensation—

in fact, louder, because the control engineer has probably brought up his amplifier gain—it is difficult to see how bass boost can be justified. And if the whole piece of music is being reproduced below natural size there is just as much need for compensation during a *ff* as during a *pp*, and more need if the activities of the control engineer are taken into account.

Complications Arise

The only true basis for compensation is the amount of scaling down—or up—between the original and the loud speaker. This bears little relationship to the receiver volume control setting, and still less to the output transformer voltage. When band numbers are being announced, the speaker murmurs gently into the microphone and may be inaudible a few yards away in the studio. Yet his voice emerges from the loud speaker at a comparable number of decibels to the whole band. Whereas the band is probably a reduced image, needing some extra bass for naturalness, the voice is an enlargement, needing reduced bass for naturalness. Short of a private line to the control room it is not evident how we can do the right thing about it by our own efforts.

It is up to the B.B.C., if to anyone. An approach to a justifiable system might be worked by assuming a standard normal room volume for the listener and introducing automatic tone compensation at the transmitting end in suitable proportion to the enlargement or reduction from the original involved in the stages between microphone and aerial. The receiver volume control could then be compensated to allow for departures from "standard room volume." But the latter without the former is as likely to make things worse as better.

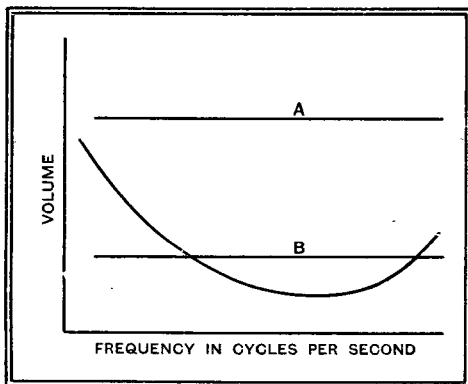

Fig. 6.—A and B represent high and low volume respectively from an amplifier and reproducer with perfectly level characteristics, compared with the curve of threshold hearing from Fig. 5.

We have already seen that compensation in the A.B.C. system has been confined to a sharp peak "in order to retain naturalness in speech reproduction." This is merely an acknowledgment of the failure of a system based on receiver output to cope with conditions which may actually demand the reverse treatment. In other words, the cure-all is made only moder-

ately effective in any one direction lest it should aggravate opposite symptoms.

Having discovered these fallacies underlying the practical application of tone compensation, it may be as well to go a little further and examine the theoretical assumptions underlying it.

The common explanation is to compare the characteristic of the ear, as in Fig. 5, with the flat characteristic of a perfect amplifier and show that when the volume is high (A Fig. 6) the whole musical scale is well represented; whereas, when the volume is reduced (B Fig. 6), the low and the extremely high tones become inaudible.

This conception arises from an imperfect distinction between intensity and loudness; and, in fact, sloppy thinking about the whole problem. The fact that the overall characteristic of the system is level does not permit one to conclude that the frequencies comprising a programme are evenly distributed in intensity. They are changing from moment to moment, of course, but at an instant when the impression received by the ear is one of uniform distribution over all frequencies, the intensity put out by the

loud speaker is represented, not by a horizontal straight line, but by one of the loudness lines of Fig. 5.

Adjustment of the volume control has the effect of sliding this line bodily up or down, and if all the loudness lines were parallel there would be no need to discuss tone compensation. But they are not, so to preserve the uniformity of tone a suitable compensation is necessary. The real trouble is that in a fraction of a second, as the programme proceeds on its appointed way, the whole balance of tone is different, and the former compensation fails to fit the new conditions.

This perhaps can be seen more definitely by making a few simple calculations based on Fig. 5. The vertical line between 64 and 128 c/s., which is actually about 90 c/s., may be taken as a representative bass tone; and 720 c/s (midway between 512 and 1,024) as representative of the middle tones that constitute so much of the most audible parts of an average of programmes. The intensity and loudness of these can be compared for various assumed conditions, remembering that any adjustment of receiver volume changes the intensity, but that the corresponding loudness must be derived from Fig. 5. The receiver is assumed to be dis-

tortionless, so that the relative intensities at 90 and 720 c/s are unaffected by adjustment of the volume control.

It is convenient to compare them in parallel columns. In the first example the two frequencies 90 and 720 c/s are assumed to be equally loud, at 65 db.; and the corresponding sound intensities are taken from the diagram. It will be noted that the receiver has to reproduce the low note 10 db. stronger for equal loudness. Now suppose the level to be reduced by 30 db. by means of a non-compensated volume control. The two notes are now no longer equal; the 90 c/s is 25 db. softer.

TABLE OF COMPARISONS.

90 Cycles per Second.		720 Cycles per Second.		Remarks.
Intensity.	Loudness.	Intensity.	Loudness.	
-16 db.	65 db.	-26 db.	65 db.	Loud reproduction; equally balanced.
-46 "	10 "	-56 "	35 "	Both reduced 30 db. by non-comp. volume-control; 25 db. discrimination between two frequencies.
-32 "	35 "	-56 "	35 "	To preserve equality, 14 db. of tone compensation introduced.
-28 "	45 "	-45 "	45 "	Original loudness in studio.
-16 "	65 "	-33 "	57 "	Reproduced at full volume: bass note 8 db. stronger than middle note.
-32 "	35 "	-63 "	27 "	Reduced 30 db. by tone-compensated vol. control: still 8 db. discrepancy.
-32 "	35 "	-40 "	50 "	Original loudness; unequal balance.
-16 "	65 "	-24 "	67 "	Reproduced at full volume: balance is affected by 13 db.
-30 "	40 "	-54 "	37 "	Reduced 30 db. by tone-comp. vol. control; discrepancy increased to 18 db.

To put matters right, the low note intensity must be given 14 db. compensation, as in the third line.

Having now fixed the amount of tone compensation required for a reduction in volume of 30 db. from the maximum, we go on to look at another example. Again, the two notes are equal, but heard in the studio at the lower level of 45 db. This might be the gentle murmuring of the announcer or the notes of the crooner. The corresponding intensities are -28 and -45. If the conditions are again such as to provide an intensity of -16 db. with volume control at intensity maximum, 12 must be added. The loudnesses are then 65 and 57, an excess in the bass of 8 db. Hence the sepulchral tones imparted to the announcer or crooner when reproduced in magnified form. Using the tone compensated volume control to abate this nuisance, the result is still found to be 8 db. higher in the bass.

Lastly, consider a crooner with a higher-pitched voice, so that the 90 c/s component is only 35 db. and the higher tone is 50. Performing similar calculations, we find that at full volume from the loud speaker the two frequencies are very nearly equalised; an exaggeration of 13 db. And when the tone compensated

Tone Compensation—

volume control is used, the bass note is actually louder than the treble; a total error of 18 db.

Other examples could be selected to show application of the same tone compensation resulting in the opposite effect, of inadequate bass reproduction. Nostrums are advertised to cure everything from bow-legs to knock-knees with one and the same dose, and no doubt this outlook lies behind the use of tone compensation.

The Masking Effect

Not even these simple calculations can give a full idea of the complexity of the problem, for they are based on the assumption that the loudness of one sound is unaffected by the presence of other sounds heard at the same time. Actually, of course, a sound heard weakly becomes weaker still or even inaudible if other louder sounds break in on it. This phenomenon is painfully familiar to those who use the telephone. So it is not legitimate to calculate the loudness of two simultaneous notes independently, much

less the many notes that make up speech and music.

There are two escapes from this imbroglio. One is to obtain a reproducer capable of almost unlimited output, having a perfectly level characteristic; to obtain a suite of listening rooms suitable for every type of programme; and to adjust one's volume control to give approximately the same intensity of sound as the original. One will have to be very quick and clever to anticipate the control engineer.

The other is to use radio to give the pleasantest sound that can conveniently be extracted from it. In that case it does not so very much matter whether one includes tone compensation or not, seeing that disturbance of the original balance of tone is bound to take place either way. All that matters is to get the nicest-sounding balance of tone. Or perhaps if it is a manufacturer who is considering the position he will lean toward including tone compensation (provided that the cost is moderate), for it is an example of modern progress.

Between these two there is plenty of room for that blessed word, compromise.

watts, authority having been received from the Federal Radio Board for the increase. WMAQ works on a frequency of 670 kilocycles (447.7 metres), and may be receivable in this country during the coming winter. Actually few Transatlantic stations, no matter how great their output rating, have been well received for a long time now if their wavelengths have been much over 350 metres. If Transatlantic reception runs true to form the longer-wave stations should be heard as we draw nearer to the next sunspot maximum. D. EXER.

BOOK REVIEW

"Les Ondes Courtes et Ultra-Courtes: Leurs Applications," by P. Hémarquier and H. Piraux. (Paris, Dunod, 1935; viii+323 pp. Price Frs. 38.60.)

IN his preface to this book the celebrated French physicist, M. André Blondel, well describes it as "an engrossing work which one reads with as much interest as a novel"; and it may be added that one need not be a distinguished physicist in order to feel this. For there is little in the first 200 pages or so which the "man-in-the-street"—assisted by

Distant Reception Notes**New French Stations Testing**

AFTER many delays the French Post Office authorities are now making good progress with the National Broadcasting Scheme based upon the Ferrié plan. Readers have probably heard three of the new stations testing outside programme hours. These are Toulouse, Lyons and Lille. The construction of other high powered stations is reported to be well under way, and transmissions from some of them should be heard before very long. Since its present location does not fit in with the scheme, Radio Normandie is being informed that it must move from Fécamp to a site near Rouen. This means that it will go from the coast to a point about 45 miles inland, and it will be interesting to see whether this has adverse effects upon its reception in this country.

M. Mandel, the Minister of P.T.T., evidently intends to keep a firmer hand on the private stations in his country. It is stated that Radio Normandie will retain its right to broadcast only so long as it complies strictly with the regulations governing wavelengths, output power and so on. This is a good sign, but one hopes especially that the rest of the French private stations will be brought to heel in the same way.

For some reason or other Kootwijk now states its output power officially as 100 kilowatts, though a week or two ago the figure given was 150. The 150-kilowatt Brasov is stated to be testing on the 1,875 metre wavelength. Presumably the tests take place at times when Kootwijk is not working, but I have not so far managed to pick up Brasov. Probably my attempts to do so have been made at the wrong times for a station of this power should certainly be well heard in this country when it is in sole possession of a wavelength so excellent for covering long distances.

It is difficult to see why the Austrian

"RADIO ROMANIA."
A picture just received from Roumania showing the 150-kW station at Brasov in the final stages of construction. Brasov is scheduled to use Kootwijk's wavelength of 1,875 metres, and unless adjustments are made, mutual interference seems inevitable.

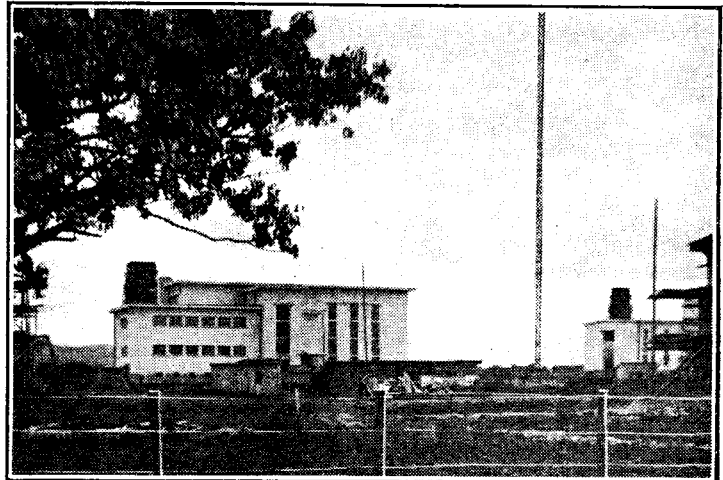

authorities still keep the Vienna experimental station going on a wavelength of 1,250 metres. One hears it occasionally when Kalundborg and Leningrad are silent, though the output power is only 0.5 kilowatt. There is no possible chance of Austria securing a long wave channel, for the wave-band between 1,000 and 2,000 metres is already over-full, and the Madrid station has yet to be fitted in.

Russian Kilowatts

The great trouble on the long waves at present is the unconscionable number of powerful Russian stations that are occupying channels. There are no fewer than nine of them with wavelengths ranging from 1,071.4 to 1,724 metres, and between them they have a total output of 950 kilowatts. They occupy no fewer than seven individual channels. Russia is a large country, but this does seem to be the lion's share, or should one say the bear's?

An American friend writes to tell me that the Chicago station WMAQ, which is at present rated at 5 kilowatts, is to raise its power in the next month or two to 50 kilo-

Chapter 7 and its well-known photograph of the splash in a quiet pool—need fail to understand, and the story of the development of the short and ultra-short radio waves is certainly the most fascinating chapter in the history of that most fascinating science, "Wireless." The existence of Ladner and Stoner's "Short Wave Wireless Communication," which covers, in a more quantitative fashion, the same field as a large part of the French book, reduces the importance of the book for the English reader; but even he will find much to interest him in the volume, particularly in the long chapter on the use of the waves in medicine; while the radio "amateur" will discover that in the later chapters—on small short-wave receivers and transmitters—he is catered for in a way not attempted by the English book, which is more interested in the large commercial equipments. With regard to ultra-short and micro-waves, work in this region has lately been so intensive in all parts of the world that nothing but a monthly or weekly journal can hope to be really up-to-date in this subject; but the authors carry the story at least far enough to point out that "it may be incorrect to state that the propagation of ultra-short waves is in no way altered by atmospheric conditions, since the phenomena of refraction are more or less connected with the state of the atmosphere and with the influence of the sun's light."

Listeners' Guide for



Photo:
M. W. Earley.

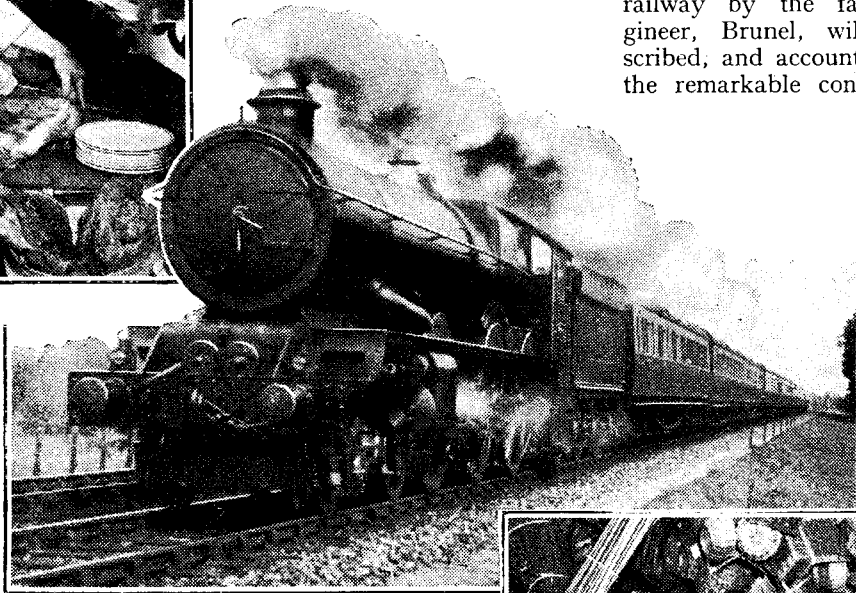

CANARY CHOIR

THOSE who bewail lack of originality in the B.B.C. programmes in these, the dog days, will find fresh talent to tickle the jaded ear on Wednesday next, September 4th, when a choir of British-bred canaries will demonstrate before the microphone the amazing strength and range of their song.

They will be under the direction of Mr. Frank Hocking, President of the British Roller Canary Association, who gives the first of four talks dealing with these popular and charming pets.

ANOTHER NERVE NUDGER

LISTENERS whose nerves are not of the strongest—and they have been sorely tried by recent broadcasts—are warned by the B.B.C. to think twice before listening to "Black Vengeance," which is to be broadcast on Wednesday next (National, 8) and Thursday (Regional, 9.10). This macabre play, which has been specially written for the microphone by Mrs. St. Loe Strachey, deals with a long-standing native curse that brought tragedy into a modern English home.

Listeners who are thinking twice about listening to it may care to know the worst.

Over a hundred years ago George Fellows, a planter in the West Indies, saved the life

RAILWAY CENTENARY. To-night at 8 the 100th birthday of the Great Western Railway will be celebrated in an actuality programme on the National wavelengths. Above is a typical West of England express near Reading. Speakers at the microphone will include a railway chef and the manager of the Lost Property Office.



of a girl who had been selected as the victim of a human blood sacrifice. The priest swore vengeance, and the planter's descendants grew up with the shadow of a dreadful death darkening their existence. How the long-awaited blow falls, how the grim priests of Voodoo claim their victim, is the theme of "Black Vengeance." I leave it to you.

RAILWAY CENTENARY

TO-NIGHT (Friday) there is a programme for those boys of all ages who are interested in railways. The main theme of this programme is the centenary of the Great Western Railway, which actually occurs to-morrow (Saturday), and listeners will be taken on an imaginary journey from Paddington to Penzance, the most

westerly rail point in England.

During the journey the story of each famous bridge or tunnel will be told, the building of the railway by the famous engineer, Brunel, will be described, and accounts given of the remarkable conditions of

SAINT-SAËNS CENTENARY

ALREADY we are verging on the fourth week of the Promenade Concert season. Undoubtedly the most significant night next week is Tuesday, the centenary of the birth of Saint-Saëns, and the concert will accordingly include the Violoncello Concerto in A Minor with Thelma Reiss as the soloist, the Fourth Pianoforte Concerto with Pouishnoff at the pianoforte, and the Symphony No. 3. The last named is somewhat unusual, being scored for orchestra, organ, and pianoforte duet. Marcel Dupré will be the organist, and the duettists Berkeley Mason and Ernest Lush.

Forthcoming "Proms" are to be broadcast as follows: Monday: Regional, 8; Tuesday: National, 8; Wednesday: Regional, 8; Thursday: National, 8.

MOTHER-IN-LAW

WHAT promises to be an oasis of fun in a sorry world is "A Marriage Has Been Arranged," a musical farce to be broadcast on Monday (National, 8).

The plot, which has been prepared by John Dighton from the story by Valentine Dunn, centres around a young man, his fiancée, and his prospective mother-in-law. The harassed hero decides that the only way to get rid of the mother-in-law—a firm-minded but unbeautiful widow—is to find her a husband. He enlists the aid of a friend running a matrimonial agency. A fierce ex-Indian army officer and an equally fierce explorer are the

30-LINE TELEVISION

Baird Process Transmissions.
Vision, 261.1 m., Sound, 296.6 m.

MONDAY, SEPTEMBER 2nd.
11.15-12.0 p.m.

Robert Easton (bass); Mario Lorenzi (harp solos); Vivien Lambelet (soprano); Cleo Nordi (dances); Cyril Smith at the piano.

WEDNESDAY, SEPTEMBER 4th.
11.0-11.45 p.m.

Sydney Jerome (syncopated piano solos); Betty Bolton (songs and dances); Rupert Harvey (cartoons and melody); John Rorke (songs); Laurie Devine ("most graceful dancer").

travel in the early days of British railways.

Living characters of the railway to-day who will come to the microphone will include the manager of the Lost Property Office, the drivers of the Cornish Riviera express and the Cheltenham Flyer, and the chef on the Torbay Express, who cooks luncheon for three hundred people a day in a room smaller than the average kitchen-scully.

I hear that the mobile recording squad has been busy in preparation for this unique broadcast, which will be given at 8 p.m. (National).

HURLING FINAL

Athlone broadcasts a commentary on the All-Ireland Hurling Final at Croke Park between 3 and 5 p.m. on Sunday afternoon.

the Week

Outstanding Broadcasts at Home and Abroad

HIGHLIGHTS OF THE WEEK

FRIDAY, AUGUST 30th.

Nat., 6.30, Burlesque: "Bertie, or Balham to the Bone." 8, "The Great Western, 1835-1935." 10, B.B.C. Orchestra, conducted by John Barbirolli.

Reg., 8, Beethoven Promenade Concert. 9.30, Arthur Young and his Youngsters.

Abroad.

Hilversum, 9.10, Tattoo and Gala Concert for Queen Wilhelmina's Birthday Eve.

SATURDAY, AUGUST 31st.

Nat., Promenade Concert. ¶B.B.C. Orchestra.

Reg., Fred Hartley and his Novelty Quintet. 9, Jack Hylton's Radio Review.

Abroad.

Vienna, 7.15, "Fidelio" (Beethoven) relayed from Festspielhaus, Salzburg.

SUNDAY, SEPTEMBER 1st.

Nat., London Zigeuner Orchestra. ¶Organ Recital by Marcel Dupré. Leslie Jeffries and Orchestra, Grand Hotel, Eastbourne.

Reg., B.B.C. Military Band. ¶Commodore Grand Orchestra. ¶Short Story: "The Chinese Picture," by Algernon Blackwood. ¶The Griller String Quartet.

Abroad.

Lipzig, 8, Opera: "La Traviata."

MONDAY, SEPTEMBER 2nd.

Nat., 8, "A Marriage has been Arranged." ¶Recital by Max Rostul (violin) and James Friskin (pianoforte). ¶Gershwin Parking-ton Quintet.

Reg., Wagner Promenade Concert. ¶"The Rocky Mountaineers."

Abroad.

Brussels II, 9, Opera: "Pallier" (Alpaerts), conducted by the composer. From the Brussels Exhibition.

TUESDAY, SEPTEMBER 3rd.

Nat., Mantovani and his Tipica Orchestra. ¶Saint Saëns Centenary Promenade Concert.

Reg., Celebrity Trio. ¶"Theatre or Cinema?" Talk by Denis Johnston. ¶Entertainment Hour.

Abroad.

Königsberg, 9, New Orchestral Music.

WEDNESDAY, SEPTEMBER 4th.

Nat., 8, "Black Vengeance," a radio play. ¶B.B.C. Military Band. ¶Transatlantic Bulletin.

Reg., Brahms Promenade Concert. ¶Recital of Irish Tunes by May Harrison (violin) and Herbert Hughes (pianoforte).

Abroad.

Munich, 9.35, Grieg Memorial programme.

THURSDAY, SEPTEMBER 5th.

Nat., 7, "Main Street of Song," a musical comedy. ¶Promenade Concert. ¶Victor Olof Sextet.

Reg., Pianoforte Recital by Philip Levi. 8.40, "The Nut Club." 9.10, "Black Vengeance."

Abroad.

Brussels II, 8, Classical Symphony Concert.

rival candidates, and before everybody is satisfactorily paired off, many complicated situations have to be straightened out.

Several new numbers have been written for the show by Peter Mendosa. The cast will include Doris Nichols, Valentine Dunn, Max Kirby, and Bobby Comber.

COMPOSER AT THE PIANO

Not all popular singers are distinguished for their musicianship, as is Peggy Cochrane, who has written many clever modern songs. On Tuesday she will give a quarter of an hour's programme of pianoforte solos and songs at the piano. It may be remembered that several of the quite haunting melodies included in the Nelson Keys revues were written by Peggy Cochrane.

OPERA ABROAD

PRAGUE opens the foreign opera programmes this week with a performance to-night at 7.30 of Smetana's three-act "Dalibor," relayed from the National Theatre. This opera, first heard when the National Theatre was opened in Prague

Vienna Philharmonic Orchestra. On the same evening at 8.40 Rome is broadcasting two light operas—"Madonna Imperia" by Alfano and "Il Tabarro" by Puccini.

A chance to compare two operas of the same title, "The Gipsy Baron," occurs to-night and to-morrow. At 8 o'clock this evening Brussels No. II relays Kollo's "The Gipsy Baron" from the Exhibition, and to-morrow Johann Strauss's more familiar opera of the same name will be given by Budapest No. I at 8.10.

On Wednesday Brussels No. I gives a concert version of Massé's "Les Noces des Jeannette" from the Exhibition studio at 9.15.

STORM TROOP MUSIC

THE Nazi Movement has its musical manifestations in the songs and marches of the Storm Troops. The first performance of some "new numbers" is to be broadcast from Königsberg at 8.10 on Thursday.

AN OPTIMIST TALKS

MR. RAWLINS, an American oil expert, believes that oil is



LOTTE LEHMANN and Luise Helletsgruber take part in the Vienna relay to-night (Friday) from Salzburg of Beethoven's "Fidelio," with the Vienna Philharmonic Orchestra conducted by Toscanini.

timist. If only for its novelty, this broadcast warrants tuning in the Kalundborg wavelength for a few moments on Sunday at 9 p.m.

A ROYAL BIRTHDAY

TO-MORROW is the birthday of H.M. Queen Wilhelmina of Holland, and Hilversum (Kootwijk) will celebrate the occasion very early with a relay from Rotterdam of a musical greeting by a choir of four thousand voices and the Rotterdam Brass Band at 7.40 a.m. Later in the day M. Vincent, the world-famous carillonneur, is giving a recital from the Royal Palace, Amsterdam, at 1.40 p.m.

RADIO BALL

COPENHAGEN radio balls are becoming a popular institution. There will be another on Thursday next from 8.10 to 2 a.m., when Louis Preil's dance orchestra will take the first turn till 11.15. Music will then be relayed from various restaurants.

On these occasions dancers are always present in the studio, as Louis Preil finds that this gives a more live atmosphere. THE AUDITOR.



Claude Hulbert and Tommy Handley appear in Entertainment Hour on Tuesday. Mantovani brings his Tipica Orchestra to the microphone the same evening.



in 1868, represents Smetana at the height of his powers.

Beethoven's only opera, "Fidelio," will be relayed to-morrow night at 7.15 by Vienna from Salzburg. This should be a great performance, for Lotte Lehmann will be singing Leonora, and Toscanini will be conducting the

to be found in the Jutland neighbourhood, and he has carried his convictions to the point of sinking bores just outside the town of Kolding. The Danish broadcasting authorities are sending "O.B." engineers and interviewers to visit the works at Kolding and interview the American op-

Burton AS5

Uniform Sensitivity and a High Degree of Selectivity on Both Wavebands

FEATURES.—*Type.*—Table-model superheterodyne for A.C. Mains. *Circuit.*—Octode frequency-changer — var.- μ pentode IF amplifier — double-diode second detector — pentode output valve. *Full-wave valve rectifier.* **Controls.**—(1) Tuning. (2) Volume and on-off switch. (3) Waverange. **Price.**—10 guineas. **Makers.**—C. F. and H. Burton, Progress Works, Walsall.

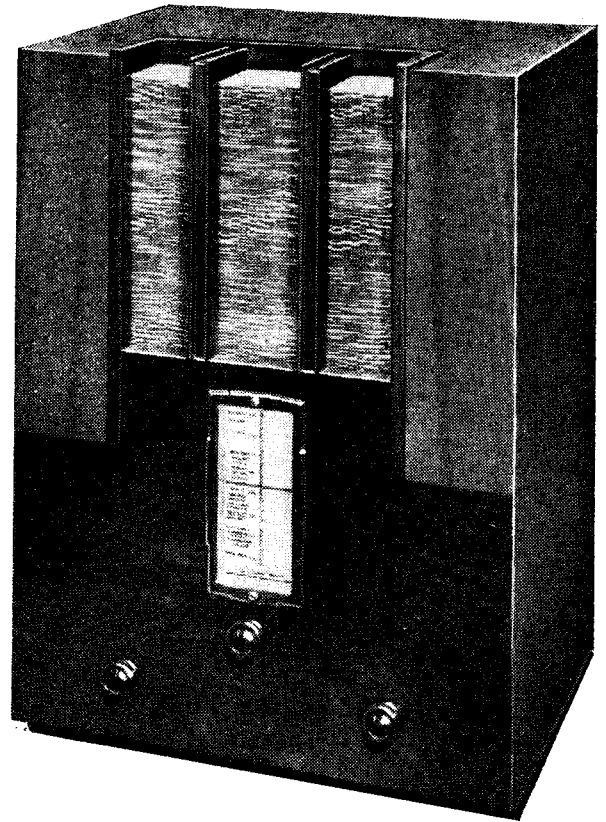

THE makers of Burton sets have hitherto specialised in the design of "straight" receivers, and when they decided to add a superheterodyne to their range of 1936 receivers no one would have blamed them for following the path so well trodden by their predecessors in this field. While the broad outline of the circuit shows that they have at least taken a peep down this road, in the detail design they have struck off on their own with characteristic independence of thought.

The aerial circuit includes an HF choke, short-circuited on the medium wave-range, which is designed to overcome whistles and repeat points of medium-wave stations on the long-wave band. To the same end, all the wiring of the pre-selector circuits which would otherwise be left open has been carefully screened.

The aerial coupling to the primary of the input band-pass filter is not switched when the waverange is changed. The object of this is to establish a self-resonant peak towards the top of the medium wave-

band so that the sensitivity is maintained where it would normally fall off due to the reduction in the L/C ratio. The same result has been achieved on the long wave-band by feeding the grids of the frequency-changer and IF valves from the same point in the AVC line without any form of decoupling. This is stated to introduce some incidental reaction which increases as the frequencies of the two circuits approach one another. The response is further aided by the "anti-break-through" choke, which is designed to peak high up in the range.

The frequency-changer valve is an octode and the first of the IF transformers is adjusted to give a band-pass response 6 kc/s wide. The second IF transformer is single-peaked, and while its secondary supplies the signal rectifying diode the primary supplies the AVC bias through the second diode. The signal diode is normally unbiased, but the noise sup-

pressor switch introduces a suitable bias from the cathode resistance of the pentode output valve. The high slope of this valve is relied upon to supply all the LF amplification required after diode rectification and it should be here noted that no provision has been made for the attachment of a gramophone pick-up. The extension loud speaker sockets are connected across the primary of the output transformer and the loud speaker field is used for smoothing. A humbucking coil is provided.

It is interesting to note that the power rectifier is of the indirectly heated type so that the smoothing condensers are un-

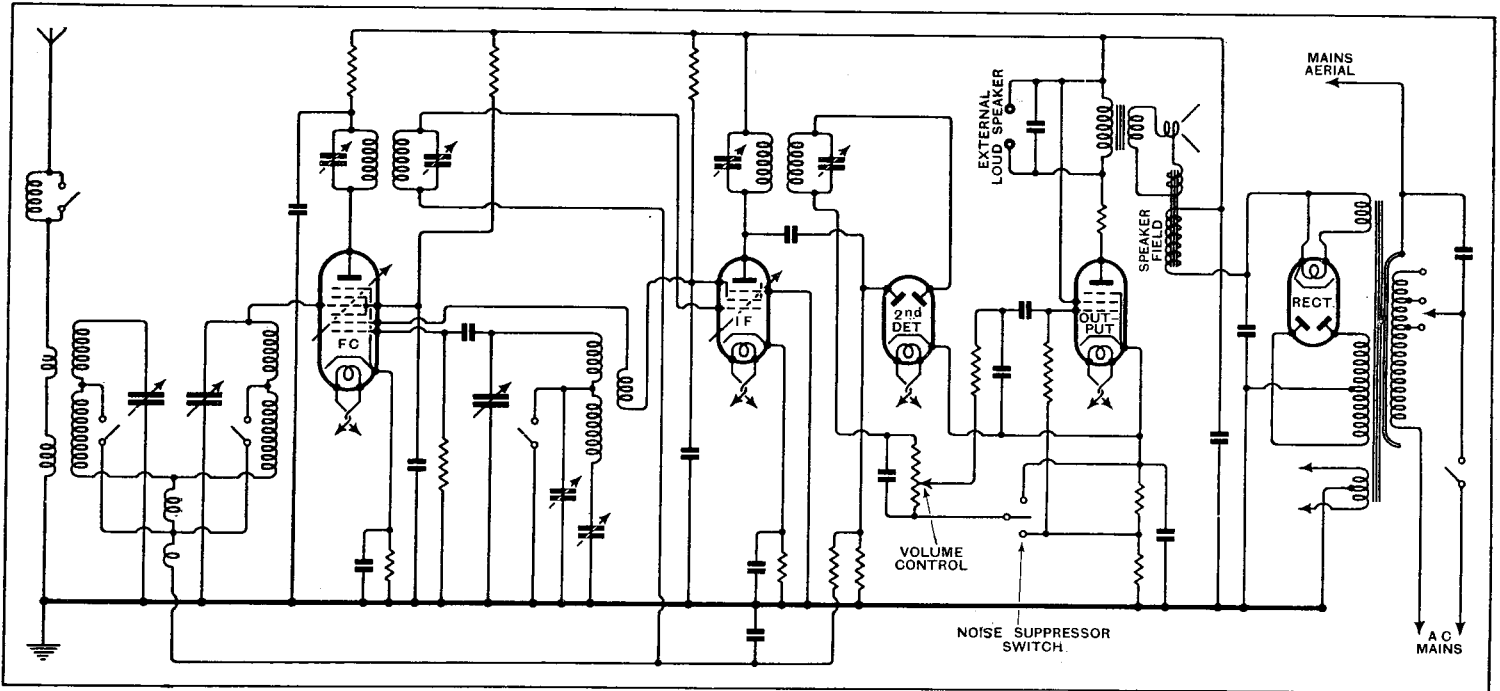

The aerial input and AVC circuits have been specially designed to give uniform sensitivity over both medium- and long-wave ranges.

Burton AS5—

likely to be subjected to more than the normal working HT voltage of the set.

The performance of the receiver is deceptive. Without the slightest fuss it pulls in all the Continental stations that sets with bigger circuit specifications seem to do with considerable greater expenditure of energy. The uniformity of sensitivity over both waveranges is remarkable, and, if anything, there is a slight tendency to increased range at the top instead of at the bottom of each wave-range.

Selectivity is unquestionably good and only a single channel was lost on either side of the London Regional transmitter

is hardly in need of a noise suppressor control. There is no trouble from whistles or any self-generated interference on the long waveband, and only one second channel whistle (at 485 metres) under the conditions of test stated above could be discovered.

The quality of reproduction does not show any obvious vices, and if there is some curtailment of the extreme top as a result of the high performance in the matter of selectivity it is not sufficiently serious to disturb the balance of tone. A special form of loud speaker mounting in which the axis of the diaphragm is tilted slightly upwards and the front of the unit is provided with an "air chamber," re-

porary mishandling the controls cannot be provoked.

In conclusion the makers are to be congratulated on the design of the illuminated vertical tuning scale which is accurately calibrated and gives a clear indication of the settings of all the principal European stations.

Murphy "28" Series

AC and DC Console Models Now Available

ALTHOUGH scheduled for release at the beginning of July, few will cavil at the delay in the appearance of these sets when the specification is examined.

The superheterodyne circuit comprises a signal-frequency HF amplifier, frequency-changer, IF stage, double-diode rectifier and AVC valve, LF amplifier with tone correction and inter-station noise suppression, and a pentode output valve. There are, in addition, two valves, whose special function is to correct reasonable errors of tuning on the part of the user. They are a double-diode rectifier and a pentode valve arranged to shift slightly the tracking of the oscillator in the event of careless adjustment of the tuning control.

There should be little excuse for inaccurate tuning, however, for the new tuning scale, let into the top of the cabinet, is of an improved type, quite free from parallax errors. The medium- and long-wave pointers work in slots in the same plane as the scale, which, in addition to wavelength calibrations, now carries a selection of station names.

As in previous Murphy Consoles, acoustic considerations have been given due weight in deciding the proportions of the cabinet.

There are separate models for AC and DC mains (no universal set is available), and both the A28C and D28C receivers cost £21 15s. Radio-gramophones on similar lines will follow shortly.

The Radio Industry

THE new season's Wearite catalogue is now available from Wright and Weaire, Ltd., 740, High Road, Tottenham, London, N.17. Like its predecessors, this publication is extremely helpful to amateurs, the uses and properties of the various components being profusely illustrated by circuit diagrams, graphs, etc. A separate list deals with Wearite standard testing instruments.

True Screws, Ltd., of 99, Clerkenwell Road, London, E.C.1, have just issued a list which deals not only with screws, but with a number of wireless parts such as terminals and tags.

To cope with increased business and new developments in marine and geo-physical apparatus, Burne-Jones and Company, Ltd., have moved into more modern premises at 309-317, Borough High Street, London, S.E.1. The telephone number is unchanged: Hop 0495.

A new illustrated pamphlet dealing with the Goltone Stratoformer noise reducing aerial system has been received from Ward and Goldstone, Ltd., Pendleton, Manchester, 6. Arrangements have now been made whereby long-wave reception can now be effectively carried out, and users of existing Stratoformers will be interested to know that auxiliary long-wave units are now available.

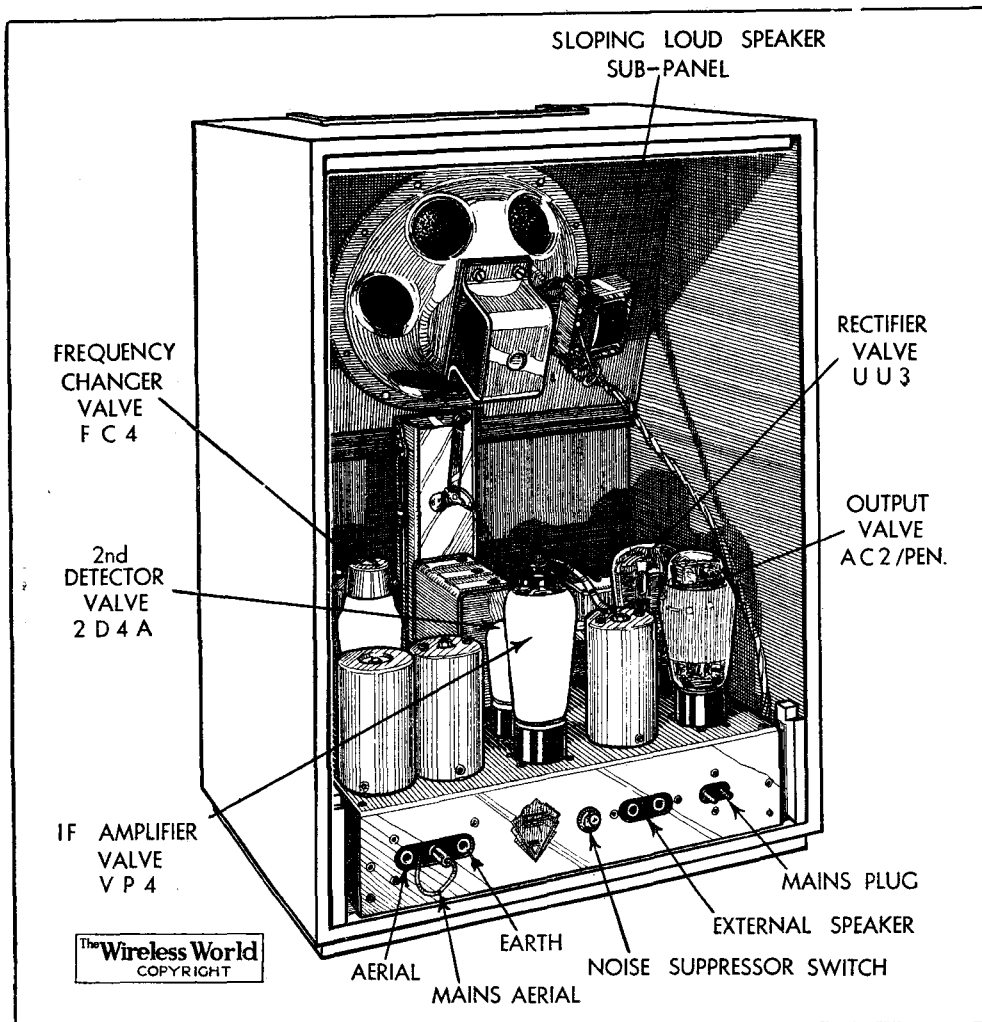

The chassis presents a particularly clean exterior appearance. Note the inclined loud speaker baffle.

when working the set in Central London, and considerably less than one channel in the case of the National transmitter. On long waves the German National transmitter was easily received clear of Droitwich and Radio Paris when both stations were working together. A little more volume might have been acceptable, but no doubt that would have resulted in some sacrifice of the exceptional freedom from background noise on this station. The noise suppressor control, incidentally, does not have any very marked effect on the general performance of the receiver, and it is only when receiving some of the weaker stations on the medium waves that its action is appreciated. The set, in fact,

sults in a type of sound distribution which removes the idea of a focus in the receiver cabinet itself.

Controlled Output

The automatic volume control gives equal signal strength from the West, North and Midland Regional transmitters, and only a small adjustment of the manual volume control was necessary to bring London Regional down to the level of the provincial stations.

The overall magnification and AVC conditions have been so adjusted that it is impossible to overload the output valve, and unpleasant distortion due to tem-

BROADCAST

By Our Special Correspondent

BREVITIES

A B.B.C. Bombshell

NOW is a black time for all ether searchers, world beaters, dial twisters and other such who have the misfortune to reside outside Great Britain. For, peradventure, they may be "logging" B.B.C. stations, slapping their chests exultantly and writing off for verifications. Alas, the B.B.C. has now decided not to issue verifications.

Precedent ?

The Corporation is, I believe, the first broadcasting concern in the world to adopt this attitude, and no doubt the International DX'ers Alliance, among other aspiring and perspiring bodies, is fervently hoping that the example will not be followed.

We all realise that members of these organisations admire and trust each other, but it is useful for reference purposes to have written verification when a station hunter using a 2-valve reflex in Ohio knows he has heard a recital on the domra in Singapore.

What Amateurs May Think

No doubt many amateurs will accuse the B.B.C. of churlishness, pointing out that they always enclose a stamped addressed envelope with verification requests, even if the stamps are not valid outside their own State. It ought to be understood, however, that it is not the postage question that bothers the B.B.C.

Their point of view, and it deserves to be considered, can be summarised under three headings.

B.B.C.'s Point of View

First, the Corporation feels that details of the transmissions can often be had from the advanced programme lists, and because unscrupulous use has been made of this information in the past, the value of any written confirmation is negligible. Secondly, official verifications are often used for advertising purposes. Thirdly, foreign transmissions, especially on short waves, are frequently relayed locally, with the result that many wireless novices imagine they have performed some incredible feat of DX work when, in reality, they have picked up a nearby relay.

Welcome Correspondence

The B.B.C.'s new decision applies to long, medium and short wave transmissions, though naturally it mostly concerns the last.

In a statement to the Empire Press the B.B.C. says: "The object of our Empire transmis-

sions is mainly to provide a service of news and entertainment to listeners in all parts of the Empire, and we feel that the lasting success of our Empire service will depend on the matter received rather than the method of its reception. . . . Correspondence of a constructive nature relative to programmes, or of a technical nature, will, we can assure listeners, be always welcome."

Other Points of View

Many readers will possibly feel that the Corporation has not given an answer likely to satisfy those listeners who may be reckoned as representing the "sporting" side of the pastime. If any readers have a new point of view to put forward I should welcome letters for publication.

the next few days, I understand, a similar order will reach the Marconi-E.M.I. Company.

It looks as if there really will be something to talk about soon in the realm of television.

Hospital Wireless

ONE of the most practical pieces of philanthropy during the past few years has been the *News-Chronicle* Wireless for Hospitals Fund. I use the word "practical" advisedly, having studied the manner in which the money is being applied.

An expert committee, including B.B.C. engineers, has now designed a "model hospital equipment." The receiver is a superhet. with AVC. There is a basic power output of 10

criticisms as those contained in the new Bulletin of the American Women's National Radio Committee which is campaigning to eliminate objectionable and distasteful broadcasts.

A "Cissy" Programme

"What a pitifully small percentage of all that is broadcast is really good," writes Luella S. Laudin, Editor of the Bulletin, and there follow such terse comments as "Radio at its worst," describing N.T.G. and his chorus girls; "just plain noise" *apropos* the Louis Prima five of New Orleans, and "the worst programme on the air," describing the John Charles Thomas serial, "Home on the Range." The G-men programme by Phillips Lord draws this comment: "This 'cissy' version of the adventures of our red-blooded G-men may be safely heard by old ladies with very weak hearts."

Miss Laudin also deplors the "personally conducted tour of the intestinal tract" represented in the advertisements of the Vox Pop series.

Forthcoming B.B.C.

Dramas

B.B.C. plans for autumn radio drama include many revivals as well as a few original plays specially written for the microphone.

Among adaptations will be Edgar Wallace's "On the Spot" and Tchekov's "Uncle Vanya," and a specially written version of Sapper's "Bulldog Drummond" is promised for early October; Eden Phillpott's "Devonshire Cream" will be heard in November, and Margaret Kennedy's "The Constant Nymph" in December.

Original Plays

The original plays include "Congo Landing" by Horton Giddy, author of the naval thriller, "In the Shadow." This time the dramatist turns to the air, and will tell the story of a record-breaking flight which ends in a forced landing in the jungle.

A play of the French Revolution entitled "Brumaire" by Anthony Ellis will be produced by Robin Whitworth early in October, while another unusual play will be an English version of "In Small Print" by the Polish writer, Madame Kolowska. Lance Sieveking has collaborated with M. Joseph Renaud, French radio-dramatist, in a new work which he has called "The Boomerang Bet." It concerns a fantastic wager made by a millionaire and the curious way in which the bet is eventually won.

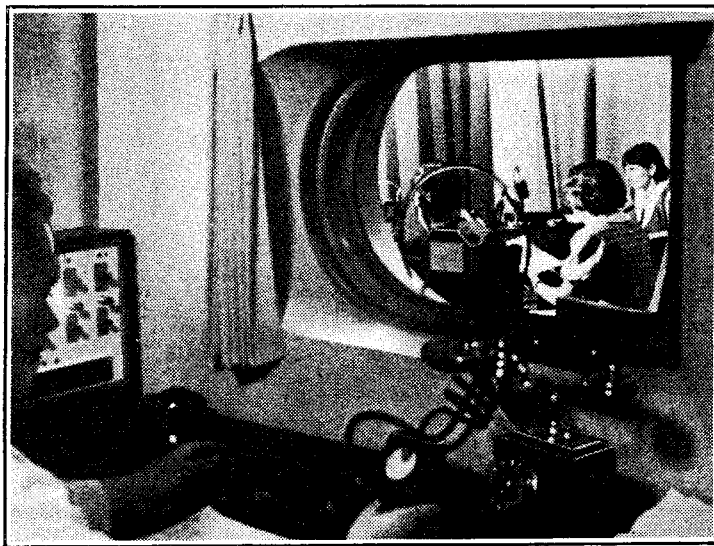

"G.B.S." IN FINLAND. A picture taken recently from the control cabinet in the Helsinki studio during the broadcasting of a Bernard Shaw play.

From the B.B.C. Postbag

"PLEASE would you kindly send me full particulars on the Wireless to the above address. Yours truly . . ."

Exit 30-Line Television

AFTER a long and not very distinguished life the B.B.C. experimental 30-line television service expires on September 15th. A year ago the mourners might have been many, but with the imminence of real television, there will be very few tears on the bier.

Already the B.B.C. has placed an order with the Baird Company for high-definition television equipment at the Alexandra Palace, and within

watts, but each hospital can have any number of 10 watt units which will, incidentally, be interchangeable, thus reducing manufacturing costs.

Near the entrance to each ward a control box would be situated with resistances which could be automatically switched in in accordance with the impedance of the loud speakers in use. Power output would be arranged on a basis of 1 watt per loud speaker point or per two hundred pairs of headphones.

Criticism with a Punch

WHEN it comes to broadcast programme criticism, women win hands down. No man, so far as I know, has had the courage to issue such outspoken

Broadcasting in South America

The Buenos Aires Wave Plan

By J. GODCHAUX ABRAHAMS



South America's most modern and striking city, Buenos Aires is often referred to as the New York of the South.

BETWEEN March 28 and April 19 last delegates from the Radio Administrations of the Argentine Republic, Bolivia, Brazil, Chile, Paraguay and Uruguay met at Buenos Aires at a Regional Conference to discuss the establishment of a broadcasting union on the lines of the International Broadcasting Union, Geneva. Decisions were taken in respect to general technical matters, and in particular to the allotment of wavelengths and frequencies to the transmitters in the individual states. In the allocation of channels, a minimum separation of 10 kilocycles was adopted in the band 550-1,500 kilocycles, but in the case of stations operating in Montevideo, Buenos Aires and La Plata the separation was extended to 20 kilocycles in order to prevent mutual interference.

As in the case of the Plan de Lucerne, three kinds of channels were adopted, namely, (a) exclusive wavelengths, (b) inter-

national common wavelengths, and (c) national common wavelengths. The new allocation of channels is to come into force on January 1, 1936.

More Stations for European Listeners

Generally speaking, the scheme has not affected in any great degree the better known transmitters in the Argentine Republic, and most of the Buenos Aires stations will be retaining their present wavelengths. From the list, however, it would appear that Uruguay, Chile, Paraguay, Brazil and Bolivia are planning a development of their respective broadcasting systems, and for the benefit of distant listeners to transatlantic broadcasts particulars of existing stations of a power of 1 kilowatt and over, and their subsequent changes, are given hereunder.

ARGENTINE REPUBLIC

Metres.	kc/s.	Call Sign and Station.	kW.
201.3	1490	LU12 Rio Gallegos	1.0
234.4	1280	LU7 Bahia Blanca (2 kW. and 1240 kc/s. (241.9 m.) in 1936)	1.4
236.2	1270	LS9 Vicente Lopez	6.0
277.8	1080	LT3 Rosario (Santa Fé)	4.5
340.9	880	LV2 Radio Central Cordoba (960 kc/s. (312.5 m.) in 1936)	2.0
365.9	820	LV7 Tucuman	1.0
375	800	LU2 Radio Nacional, Bahia Blanca (2 kW. and 900 kc/s. (333.3 m.) in 1936)	0.5
384.6	780	LT1 Broadcasting del Litoral, Rosario, Santa Fé	4.0
468.8	640	LV12 Tucuman (in 1936)	2.0
483.9	620	LV3 Cordoba	2.0

BUENOS AIRES

Metres.	kc/s.	Call Sign and Station.	kW.
222.2	1350	LS6 Radio del Pueblo	4.5
229	1310	LS7 Buenos Aires (10 kW. in 1936)	4.0
236.2	1270	LS9 Radio La Voz del Aire	6.0
243.9	1230	LS8 Radio Stentor	15.0
252.1	1190	LS2 Radio Prieto	30.0
260.9	1150	LR8 Radio Paris	7.0
270.3	1110	LS5 Radio Rivadavia	5.5
280.4	1070	LR1 Radio El Mundo	50.0
291.3	1030	LR9 Radio Fenix	4.0
303	990	LR4 Radio Splendid	15.0
315.8	950	LR3 Radio Belgrano	25.0
329.7	910	LR2 Radio Argentina	9.62
344.8	870	LR6 Radio La Nacion	37.0
361.4	830	LR5 Radio Excelsior	30.0
400	750	LR7 Radio La Prensa (15 kW. in 1936)	2.0
422.5	710	LS1 Radio Municipal (20 kW. in 1936)	5.0
447.8	670	LS4 Radio Portena	5.0
476.2	630	LS3 Radio Mayo	5.0
508.5	590	LS10 Radio America	6.0

URUGUAY

Metres.	kc/s.	Call Sign and Station.	kW.
201.3	1490	CX48 Radio Palermo, Montevideo	1.5
206.9	1450	CX46 Montevideo (2 kW. in 1936)	0.25
212.8	1410	CX44 Montevideo	1.0
219	1370	CX42 Montevideo (1380 kc/s. (217.4 m.) in 1936)	1.0
225.6	1330	CX40 Montevideo (1 kW. in 1936)	0.5
232.6	1290	CX38 Montevideo	5.0
240	1250	CX36 Montevideo (3 kW. in 1936)	0.25
247.9	1210	CX34 Montevideo (2 kW. in 1936)	0.5
258.6	1160	CW31 Salto (1 kW. in 1936)	0.25
265.5	1130	CX30 Radio Nacional, Montevideo (1 kW. in 1936)	0.5
267.9	1120	CW29 Durazno (2.5 kW. in 1936)	0.5
275.2	1090	CX28 Montevideo (3 kW. in 1936)	2.0
277.8	1080	CW27 Salto (7 kW. and 680 kc/s. (441.2 m.) in 1936)	0.25
285.7	1050	CX26 Radio Uruguay, Montevideo (7 kW. in 1936)	2.0
297	1010	CX24 Montevideo (10 kW. in 1936)	2.0
309.3	970	CX22 Montevideo (1 kW. in 1936)	0.25
322.6	930	CX20 Montevideo (2 kW. in 1936)	0.25
337.1	890	CX18 Montevideo	3.0
352.9	850	CX16 Montevideo	10.0
370.4	810	CX14 Montevideo (10 kW. in 1936)	5.0
389.4	770	CX12 Montevideo (5 kW. in 1936)	1.0
410.7	730	CX10 Montevideo (3 kW. in 1936)	1.0
434.8	690	CX8 Radio Electrica, Montevideo (3 kW. in 1936)	1.0
461.4	650	CX6 Montevideo (50 kW. in 1936)	10.0
512	585	CX4 Montevideo (5 kW. and 610 kc/s. (491.8 m.) in 1936)	1.0

PARAGUAY

Paraguay has been allotted twelve channels of which two only are exclusive, viz., 560 kilocycles (535.7 metres) and 700 kilocycles (428.6 metres), which will be taken up respectively by ZP1, Asuncion, now on 1135 kilocycles (264.3 metres), and by a new station to be built at Villaricca. ZP4, a small 150-watt

station, also situated in the capital and operating on 1275 kilocycles (236.2 metres), will take over the wavelength of 730 kilocycles (411 metres) in 1936, and may blossom out as a more powerful station. Asunción, in addition, possesses a number of small broadcasting plants to which the new plan allocates channels of an international or national common character.

BRAZIL

Metres.	kc/s.	Call Sign and Station.	kW.
220	1363.6	PRC6 Rio de Janeiro (980 kc/s. (306.1 m.) in 1936)	1.0
260	1153.8	PRA9 Rio de Janeiro (1100 kc/s. (272.7 m.) in 1936)	1.0
300	1000	PRB4 Sao Paulo (1120 kc/s. (267.9 m.) in 1936)	1.0
350	857	PRA6 Sao Paulo (1800 kc/s. (166.7 m.) in 1936)	1.0
400	750	PRA2 Rio de Janeiro (740 kc/s. (405.4 m.) in 1936)	1.5

BOLIVIA

A number of national common and international common channels have been allotted to Bolivia, as well as two exclusive

wavelengths, namely, 550 kilocycles (545.5 metres) and 1,020 kilocycles (294.1 metres) which will be taken over respectively by:—

Radio Nacional, CPX, La Paz, now on 1,240 kc/s. (242 m.) and Radio Boliviana, CP4, La Paz, now on 1,040 kc/s. (288.5 m.).

CHILE

Possesses a large number of small stations which, with the exception of those enumerated below, do not, in the majority, surpass 250 watts in power:—

Metres.	kc/s.	Call Sign and Station.	kW.
304.6	985	CE98 Radio Universo, Santiago (1180 kc/s. (254.2 m.) in 1936)	1.0
317.5	945	CE94 Radio Chilena, Santiago (1140 kc/s. (263.2 m.) in 1936)	1.0
331.5	905	CE90 Radio El Mercurio, Santiago	1.0
340.9	880	CE88 Valparaiso (760 kc/s. (394.7 m.) in 1936)	1.0
344.8	865	CE86 Radio Pacifico, Santiago	1.0
363.6	825	Santiago	1.0
382.2	785	CE78 Santiago	1.0
425.5	705	CE70 Santiago	1.0
451.1	665	CE66 Santiago	1.0
480	625	CE62 Santiago (1060 kc/s. (283 m.) in 1936)	1.5
512.8	585	CE58 Santiago (570 kc/s. (526.3 m.) in 1936)	1.0

Radio Data Charts—IX.

The Comparative Efficiency of Gapped and Ungapped Chokes and Transformers Carrying DC

By R. T. BEATTY, M.A., B.E., D.Sc.

IN previous articles¹ we have given design data for iron-cored chokes and transformers which are subjected to AC excitation only, such as a choke in a parallel-feed circuit or a balanced output transformer. Similar data have been given for chokes and transformers which carry DC superposed on an AC signal, such as transformers whose primary is directly connected to the plate of a valve, or smoothing chokes which carry the rectified current from an AC mains supply in addition to the ripple which is to be smoothed out by the filtering action of the choke and its associated condenser.

When a superposed DC is carried by the winding, the inductance is always increased by inserting an air gap of suitable length in the magnetic circuit, and usually such a gap is essential in the output stage where the DC current is large, except when special circuits such as push-pull are used to balance out the steady magnetic flux in the iron. But when the DC current is small, as in interstage circuits, the question often arises as to whether it is worth while to introduce a gap, and the accompanying chart has been designed to give an immediate answer to this question.

Use of the Chart

For example, we see that if we have a Stalloy core excited by a small signal ($\sim B$ small) and with the winding traversed by 1.7 ampere-turns, the inductance with no air gap in the core is 80 per cent. of the inductance when the optimum gap is inserted. In such a case we might be justified in deciding that the gap is an unnecessary refinement. Further, if it is specified that the DC current to be carried amounts to 3 mA., we immediately learn that the corresponding number of turns/inch works out at $1.7/3 \times 10^{-3} = 567$, so that if the ungapped choke is to maintain

80 per cent. efficiency compared with the same choke with the best gap inserted, the turns/inch must not exceed 567. Armed with this information we can at once find (from the previous charts already referred to) the size of choke necessary to give the required inductance.

The chart deals with conditions where the ungapped inductance falls to a limit of about 50 per cent. of the gapped inductance, which is a sufficiently large range to cover practical cases, for if the inductance can be doubled by the insertion of a gap we should certainly insist on a gap. In the case of Laminic, however, the existing data are insufficient to reach this limit, and all we can say is that with 2 DC amp.-turns/inch the efficiency of the ungapped is still 96 per cent. of the gapped choke. It is to be hoped that more extensive data will be made available for this material.

Some Interesting Conclusions

Taking a limit of 80 per cent. efficiency as the limit above which a gap is unnecessary we find the corresponding values of m , the DC amp.-turns/inch:—

Core Material.	m
Stalloy	1.7
E.S. Stalloy	1.2
Radio-metal	1.6

The above table refers to the case of small values of AC signal. As remarked before, the number for Laminic is not yet available.

This table affords some valuable information. Thus, if the winding must be traversed by a DC of 3.2 mA., and we wish to know primarily whether a gapped core is necessary, we see that at 80 per cent. efficiency an ungapped core must be wound (in the case of Radio-metal) with not more than $1.6/3.2 \times 10^{-3} = 500$ turns per inch, and so we have obtained

¹ "The Design of Iron-cored Chokes and Transformers Carrying AC Only," *Wireless World*, July 26th, 1935, pp. 84-86; "The Design of Gapped Iron-cored Chokes and Transformers Carrying DC," *Wireless World*, August 2nd, 1935, pp. 108-111.

COMPARATIVE INDUCTANCE WITH GAPPED AND UNGAPPED CORES

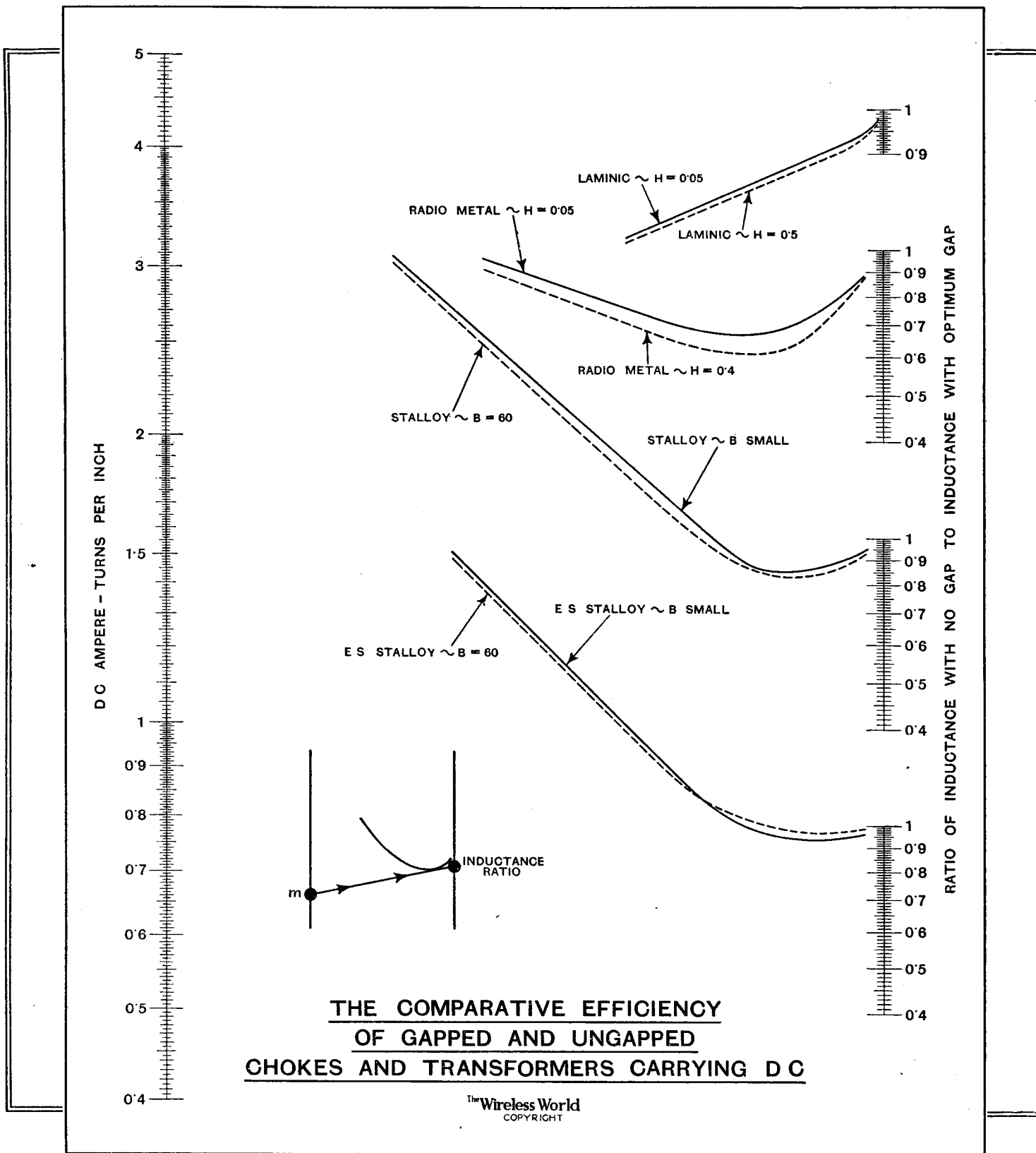

an essential figure for working out the detailed design for any specified value of inductance.

Again, if we consider an output transformer whose primary winding is required to carry 32 mA. of direct current, by reference to the above table we see that if an ungapped core of Radio-metal is to be used at an efficiency of 80 per cent., the turns/inch must not exceed $1.6/32 \times 10^{-3} = 50$. This small number of turns per inch is quite insufficient to allow a transformer of primary inductance of, say, 30 henrys to be constructed except by use of an unreasonably large core. In fact, we should require 356 cubic inches of iron. This figure is obtained as follows: From the previous chart dealing with AC only we find that with $n = 50$

and $V = 356$, the inductance with a Radio-metal core is 54.8 henrys. The next chart, which shows the effect of superposing DC and inserting the optimum gap, shows that when $m = 1.6$ the inductance is brought down to $54.8 \times 0.685 = 37.5$ henrys, and the present chart shows that the removal of the gap causes a further reduction to $37.5 \times 0.8 = 30$ henrys. Any reader who possesses drawings giving the dimensions of various sizes of stampings can work out for himself the critical number of turns per inch corresponding to cores made up from each size of stamping, and so can see at a glance whether an ungapped core is permissible in any particular case. Lack of space precludes us from giving the detailed results in this article.

Readers' Problems

Loosened Valve Base

ALTHOUGH the trouble is not quite so common as it was, it is still not unusual for a valve to develop looseness between the glass bulb and the base.

A reader whose LF amplifying valve has developed this fault enquires whether it will be safe to continue to operate the valve; apparently it is still working normally and the anode current has remained unchanged.

There is no actual danger in using the valve in this condition, but, of course, great care must be taken to avoid imposing strains on the leading-out wires, as they are completely unsupported.

It may be pointed out that it is usually quite easy to repair a loose valve by introducing some suitable form of adhesive, such as shellac or even Seccotine, between the bulb and the base.

Alternatively, it is fairly easy to make a repair on the lines indicated in the accompanying photograph.

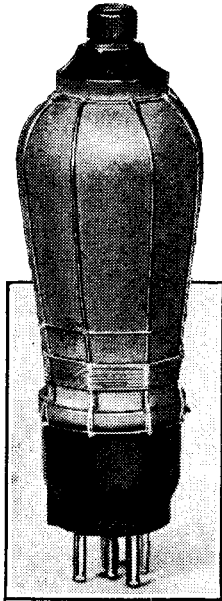

A loose valve bulb may be firmly secured by means of wire binding.

Short-circuiting the AVC

A READER who is using a Single-Span receiver has noticed by accident that signal strength is appreciably increased by touching the aerial lead-in wire.

This seems to be rather a puzzling effect, but we think that there is a very simple explanation for it. The effect of touching the aerial is to introduce a resistance (which in some circumstances may have quite a low value) between aerial and earth terminals of the receiver, and consequently to apply a partial short-circuit across the source of AVC bias. As a result, the amount of negative bias is reduced, and it is natural that a fairly strong incoming signal should be reproduced at increased strength.

The same effect could, of course, be obtained by permanently connecting a fixed resistance, but it is not desirable to do so, as the effectiveness of the AVC system would be impaired.

Dodging Atmospherics

WHEN correspondents complain of atmospheric interference we know that they are real long-distance listeners; thanks to the high power of most European stations and the favoured situation of this country, medium-distance working is seldom hampered by "X's."

Science has as yet provided us with no

real cure and few effective palliatives for atmospheric, but a rather interesting aspect of the question has been raised by a querist who is interested in the consistent reception of several of the more distant stations. He has found by experience that interference during the present summer has been more marked on the long than on the medium waveband. He goes on to ask whether it may be assumed that still greater immunity from atmospheric may be expected on the short wavelengths; it so happens that most of the transmissions in which he is interested are simultaneously broadcast on this band.

Short waves generally are freer from atmospheric than the normal broadcast bands. Here we have an illustration of the advantages of an "all-wave" set for serious reception—as opposed to casual reception of anything that happens to be coming through well at the moment.

Time to Renew ?

A CONSCIENTIOUS reader, who has just gone to the trouble of measuring the anode current of all the valves in his receiver, finds that the current passed by most of them is only slightly subnormal, with the exception of the intermediate LF amplifier. The consumption of this valve has fallen by rather more than 25 per cent. as compared with its original value (which coincided almost exactly with the manufacturer's rating). We are asked to say whether the valve should be renewed.

When the best possible performance is expected from the set, we generally make it a rule to replace valves when the anode current has fallen by 25 per cent. But as to whether it is really necessary in this case is difficult to say. Intermediate LF stages vary so much; some of them have to work at almost full capacity, while others have to deal with quite small signal voltages.

Hum with a Pick-up

THE user of a universal AC-DC receiver complains of loud hum when the set is used with a gramophone pick-up. By a process of elimination the trouble has been traced to the gramophone turn-table motor, which we assume to be of the universal commutator type.

The Wireless World

INFORMATION BUREAU

THE service is intended primarily for readers meeting with difficulties in connection with receivers described in *The Wireless World*, or those of commercial design which from time to time are reviewed in the pages of *The Wireless World*. Every endeavour will be made to deal with queries on all wireless matters, provided that they are of such a nature that they can be dealt with satisfactorily in a letter.

Communications should be by letter to *The Wireless World* Information Bureau, Dorset House, Stamford Street, London, S.E.1, and must be accompanied by a remittance of 5s. to cover the cost of the service.

Personal interviews are not given by the technical staff, nor can technical enquiries be dealt with by telephone.

THESE columns are reserved for the publication of matter of general interest arising out of problems submitted by our readers. Readers requiring an individual reply to their technical questions by post are referred to "The Wireless World" Information Bureau, of which brief particulars, with the fee charged, are to be found at the foot of this page.

Our correspondent will probably be able to effect a cure by partially screening the motor; the sheet metal used for the screen should, of course, be earthed.

There is more than a possibility that the trouble is not really due to true hum but to the fact that the motor is causing radio-frequency interference to which the receiver may be susceptible even when operating purely as a gramophone amplifier. If there is any sign of sparking at the brushes it would be well to replace them, and also to clean the commutator.

A Phantom Resistance

A QUERIST, who has recently tried to improve the selectivity and sensitivity of his four-valve superheterodyne by adding an HF stage, asks our help in overcoming a difficulty he has encountered.

When the additional stage of amplification is in use, all the usual symptoms of instability are present, and stable working

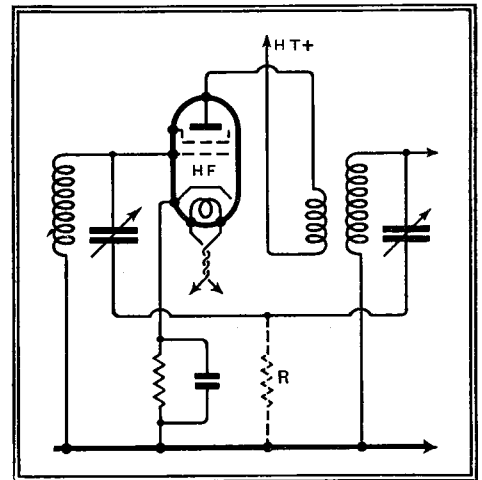

Fig. 1.—How defective earthing of a ganged condenser causes instability.

can only be obtained by reducing HT voltage applied to the extra valve to such an extent that the general behaviour of the set is little better than before.

So far as stability is concerned, the signal-frequency amplifier of the superheterodyne presents practically the same problems as that of the "straight" set. The possible causes of inter-action are numerous, but nowadays the most frequent one is brought about by a bad connection between the ganged condenser and the earth line (or chassis) of the set. In effect, a common resistance is introduced into both grid and anode circuits; this matter will be easy to understand by referring to Fig. 1, in which the "phantom" resistance which is very probably causing the trouble is marked R. The remedy is to connect the frame of the condenser to the earth line at several points and not to depend on incidental contacts such as those made by bolting down the condenser to the chassis.